

**MODEL**

**ROCKET**

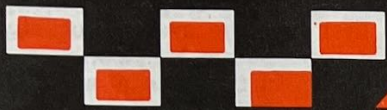

**NEWS**

**VOLUME 10, NO. 1**  
**FEBRUARY 1970**



**INDOOR  
LAUNCH**

See **NOTES FROM  
THE BOSS** - Page 4

# LOOKING BACK

## The Decade in Model Rocketry

By Bill Simon

How would you like to be able to memorize the entire Estes catalog? It wouldn't have been hard in 1960 -- the catalog was one side of a single 8-1/2 x 11 sheet of paper. Model rocketry and Estes Industries have grown together through the past decade. The story of model rocketry in the '60's is the story of Estes Industries and its customers.

Although both model rocketry and Estes Industries originated a few years earlier, the hobby was still an infant when the decade began. Almost every rocket flown was a parachute model. Some other recovery systems had been invented, but few rocketeers knew about them; even fewer had built rockets to use them. Three of the systems (tumble, feather-weight and blow-off fin) had been invented the year before by a young man named Vern Estes.

Four engine types were available--A.8-3; A.8-4; B.8-4 and B.8-0. It was late 1960 when 1/2A engines were introduced. Parachutes were squares of heavy, colored plastic with kite string shroud lines. The Estes catalog listed two body tubes (one long and one short), two nose cones, a shock cord, a plan booklet (featuring the Sky Bird, the Arrow C and the Orange Bullet) igniter material, a fin unit and two launching guides.

During the next year, 1961, model rocketry really began to move forward. The Electro-Launch and the Astron Scout were introduced in March. John Schutz and Vern Estes developed the first boost glider in late spring and early summer. The Astron Mark kit was added in December. Early in the year the first issue of a new publication, the Model Rocket News, was sent out to about a thousand Estes Rocketeers. The big news was a new series of engines (Series II), offered on an experimental basis. Two types were available -- the B16-0 and the B16-5 (now known as B14-0 and B14-5). Other new engines included the B.8-6, A.8-0 and 1/2A.8-4.

Early 1961 saw the publication of the first Estes technical report, TR-1 on stability. Other publications included the second issue of the Model Rocket News and a big new 20 page catalog...printed on a mimeograph and stitched together on Mrs. Estes' sewing machine.

Penrose, Colorado became the "Model Rocket Capital of the World" in August of '61 when Estes Industries moved down from Denver. The



Estes Industries' main office in 1961...

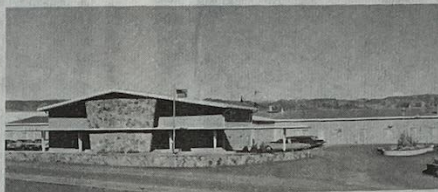

... and today.

company employed four people at that time.

More exciting developments came in 1962. Early in the year, the Space Plane became available as a kit and a whole new challenging field for their research and experimentation

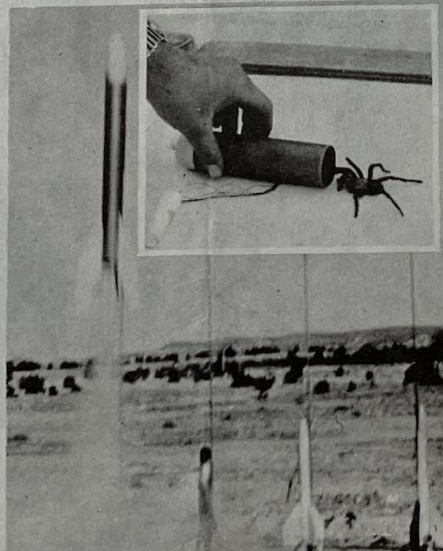

Terry Tarantula boards payload section, then blasts off on maiden voyage of prototype Astron Ranger, first cluster kit.

opened to America's rocketeers. Altitude tracking first became practical for many rocketeers with the introduction of the Altiscope. The number of kits available to the rocketeer more than doubled during

the year with the addition of the Streak, Apogee, Ranger and Phantom.

The Estes catalog published in the Fall of '62 reached 44 pages. It brought such new things as light-weight body tubes (BT-10, 20, 50, and 60), adapters (both paper and balsa), and 1/4A engines. The light-weight body tubes were destined to revolutionize model rocketry -- for the first time the average rocketeer could build a true high performance rocket. Up to this time a model the size of a Ranger was considered huge. Compare this with today's Saturn model!

During the next year the Estes catalog grew to 60 pages, adding such items as the Wac Corporal, the Tilt-A-Pad, printed parachutes, a unique boost glider called the Falcon and the first three-stage kit -- the Farside.

With front engine boost gliders, scale models, 3-stage rockets, trackers and 23 different types of engines, one rocketeer decided that model rocketry had developed to the limit. He wrote, "I'm giving all my supplies to my little brother. There's nothing left to develop and I can't see flying model rockets just for fun."

What was left? Part of the answer came in the next two years. A rocket camera, the Camroc, was intro-



The first Camroc picture was taken on a hand-cut piece of film.

## Model Rocket News

© ESTES INDUSTRIES 1970

The MODEL ROCKET NEWS is published by Estes Industries, Inc., Penrose, Colorado. This publication is written for America's model rocketeers to promote safe youth rocketry, distribute current technical information and make model rocketry more enjoyable and educational. Current issues of the MRN are distributed free of charge to all active Estes customers.

Vernon Estes ----- Publisher  
William Simon ----- Editor

duced -- aerial photography became practical for the rocketeer. Clear plastic fins made their debut with the Gemini-Titan. Realistic flying scale models of finless space vehicles could be built by any rocketeer! The Electro-launch got a plastic case to replace its wooden battery box.

As the nation's space program progressed, more and more interest turned to the Apollo project and the Saturn series. One rocketeer wrote to ask, "Would it be possible to build a model of the Saturn-I using BT-50 tubes for the first stage tanks? How many engines would it take to power it?"

The rocketeer's question started staff members thinking -- and gluing tubes together. The result was the development of the Saturn IB, the first "super" scale kit. Work on this model began in 1965, carried on through 1966, and resulted in the introduction of the kit in early 1967.

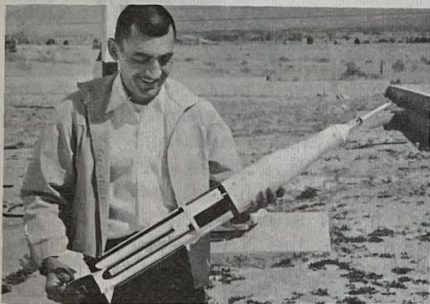

*Gene Street, designer, with first Saturn IB model after its successful maiden flight.*

Work on the Saturn progressed slowly during 1966 because other projects had to be completed, too. Scale models developed included the Arcas, Honest John and Thor-Agena B. A new recovery system was introduced in the Astron Gyroc. Beginning rocketeers got a helping hand along their way with the development of the Astron Alpha. One of the most interesting designs of the year was the "Space Twins". This model introduced the parasite glider concept, consisting of a core vehicle

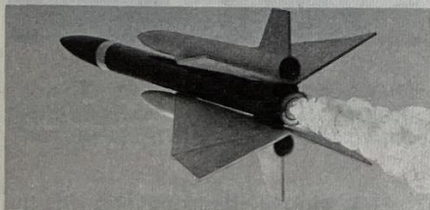

*Space Twins*

with twin gliders mounted on it. The gliders separated at ejection, flying around in "formation" as the core descended by parachute.

Although model rocketry originated in America, it soon moved beyond our borders. The success of model

rocketry around the world was shown in May, 1966 by the first International model rocket competition, held in Dubnica, Czechoslovakia. When the contest was over and the scores tallied, the United States had taken overall second place with the hosts in first place. Estes Industries was represented in this contest by Vern, Gleda and Betty Estes who together brought home three of the eighteen trophies awarded to winners in the meet.

The important technical event of 1966 was the publication of Doug Malewicki's altitude prediction report. Now a rocketeer could determine, easily and accurately, before launching, how high his rocket would go. This report also made it possible for a rocketeer to determine the aerodynamic drag on his model without using a wind tunnel.

In 1967 model rocketry changed from English measure to the Metric System for engine measurements and designations. The B.8 engine became the B6, the B3 became a B14. Total impulse measurement changed from pound seconds to newton seconds.



*Astronaut Thomas Mattingly launches model rocket during 9th Annual NAR meet at Mankato, Minnesota in August, 1967.*

A noteworthy advance in launching equipment came with the C-rail. This system provided a rigid guide which could be used with a small lug on the rocket, allowing safer, straighter launches for larger models. Models introduced included the Saturn IB, the Little Joe II, the Trident, the Starlite and the Nighthawk.

In 1968 the Estes catalog grew to 100 pages, the Model Rocket News got a new face, Estes Industries celebrated its 10th anniversary, and a new contest, the Design of the Month Contest, was begun.

Meanwhile, in New Mexico model rockets were streaking down a wire "track" while a laser beam lanced out to track them. This system simulated, in miniature, the operation of the "big" rocket sled track, allowing engineers to perfect their

systems (and saving taxpayers thousands of dollars).

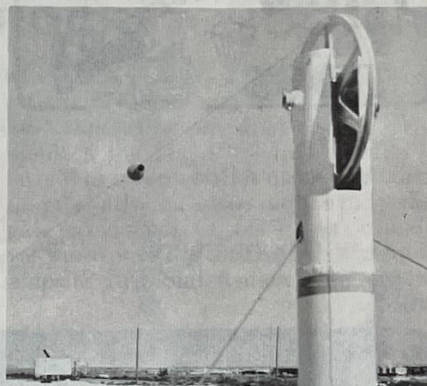

*Rocket "sled" streaks down wire towards laser tracking station.*

America's manned space program got into the "air" again with the launch of Apollo 7. This was followed by the historic Christmas-time launch of Apollo 8 around the moon. Apollo 8 was still on its way when Sven Englund learned that he had won the first Estes Launchstakes and a trip to Cape Kennedy to view the launch of Apollo 11.

With the introduction of the 1:242 semi-scale Saturn V kit, many rocketeers joined in "Project Support". These modelers launched their rockets to the countdown of the "real" bird, demonstrating their support and encouragement for our nation's space program.

The biggest event in 1969 for all of us was, of course, the landing of the first man on the moon. Second place for excitement for those of us here at Estes Industries was our merger with Damon Corporation, makers of electronics equipment for space flight, educational apparatus and advanced medical equipment.

The last year of the decade saw the introduction of several very important models. The Mercury-Redstone model brought scale modelers to the beginning of manned space flight; the 1/100th scale Saturn V brought them right to the present; and the Orbital Transport and Mars Lander models took model rocketry 10, 15 or maybe 20 years into the future.

*What does the future hold for model rocketry? Perhaps the New Years Eve launch in the Astrodome before a crowd of 55,000 -- the largest group to ever view a model rocket launch, gives a clue. All of us at Estes Industries are excited at the prospects for model rocketry in the 70's. We feel that model rocketry is really just getting started.*

# NOTES FROM THE BOSS



"Hey, Bill!" "I just got a phone call from some fellows down in Texas who have just come up with a great idea. They want to launch our big Saturn V INDOORS." These were my words as I rushed into Bill Simon's office.



*The Lift-off! 55,000 spectators watch as the Estes Saturn V rises almost to the ceiling. The rocket, built by Mark Evans, is now set aside for placement in the Estes Museum of Model Rocketry.*

"Hah!" answered Bill, (known for his down-to-earth, level headed practicality), "I can see it now. A new first in model rocketry! Saturn V crashes on the way up!"

"No not really. What they have in mind is to launch a big V in the Astrodome, a real "Texas sized" building, during the half time activities of the Bluebonnet Bowl game on New Year's Eve. Paul Haney, the famous voice of NASA will do the countdown and . . . . ."

"Wait a minute," interrupted Bill, "how high is that building anyway? Let's have Ed run some calculations and see just how close we can come to the top using our new "D" engine."

Well, now that Bill had calmed me down and oriented our thinking along a practical line, the facts started falling into place. The ceiling is 196 feet to the rafters. Ed Brown's

**COVER PHOTO:** Estes Saturn V lifts off as 55,000 spectators watch in Houston Astrodome, December 31, 1969.

Vol. 10, No. 1 - Page 4

calculations showed that the new "D" engine would raise the Saturn V to about 230 feet. That meant she'd be going about 40 feet per second when she connected with the rafters. Not quite satisfactory for a demonstration in front of 55,000 football fans and a few million T.V. watchers. So we discussed the matter and decided this event was important enough to "pull the plug" and give it all we had.

The Estes engine department went to work and came up with a special

"D" engine with just enough oomph to eject the parachute 20 feet under the rafters. Ed assured me that his extensive tests on the special engines showed the total impulse to be running within plus or minus 3%. Even if we used one of the "hot" ones his calculation showed we'd still miss the rafters by a good 2.061 feet. (Whew!)

During the time we were ironing out the special engine problems, the NASA-Apollo Section in Houston was busy at work preparing the launch equipment which included a scale model of the Saturn V tower fitted with a regular C rail for lift-off. A standard FS-5 launch control system was prepared and a 12 volt hot shot battery obtained to supply the power. Mark Evans, a leader member of the club, built the Estes Saturn V from a kit. When Bill and I arrived a couple of days before the launch most of the preparations had been made and the final 48 hour countdown for the launch began.

At T minus 36 hours Forrest McDowell, the club's advisor, got all his crew together in the Astrodome and we ran through a full launch dress rehearsal. Two launches of the

Saturn V showed us to be right on target. Both were impressive flights and the rocket and the ceiling came through unscathed.

Then waiting -- uneasy waiting, as the countdown proceeded. T minus 12 hours, the crew was up for the day to eat a hearty breakfast. T minus 5 hours, each piece of equipment was checked and rechecked. T minus 4 hours, final plans were made for travel to the launch site. T minus 3 hours, the journey to the launch site started. T minus 2 hours 45 minutes, crew held up in a freeway traffic jam. T minus 2 hours, arrive at Astrodome just as game starts. T minus 30 minutes, final check out of all systems. T minus 15 minutes, half time activities begin. T minus 3 minutes 30 seconds 12 test rockets launched from end zones -- mostly Alphas with A5-2S engines. T minus 20 seconds, crew transports launcher with rocket in position to 40 yard line near center of field. "T minus 5- 4- 3- 2- 1- LAUNCH!" comes the famous countdown voice of Paul Haney. Then a perfect lift-off as the rocket rises rapidly toward the ceiling then arches over and ejects its three big parachutes. A cheer from the crowd was heard as the big bird began its slow decent. We all felt good, like the NASA scientists must feel when THEIR big Saturn turns in a successful flight.

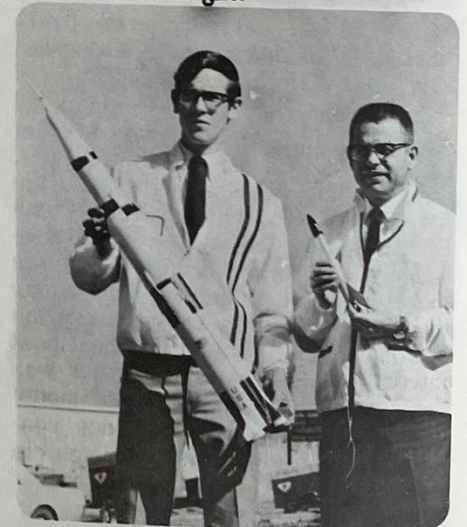

*Mark Evans and Vern Estes display the Saturn V and Astron Alpha flown in the Astrodome.*

A world of thanks goes to the NASA-Apollo rocket club section of the NAR for the fine job they did in arranging for and carrying out this special event for model rocketry.

*Vern*

# THE IDEA BOX



## DRILLING NOSECONE BLOCKS STRAIGHT

Curt Gilmore, Johnstown, Pa. suggests a hand drilled hole may be guided by first centering a spool over the spot where you plan to drill. Hold the spool firmly in place—insert drill bit and start to drill.

(A strip of masking tape around the drill bit will serve as a depth-gauge if desired.)

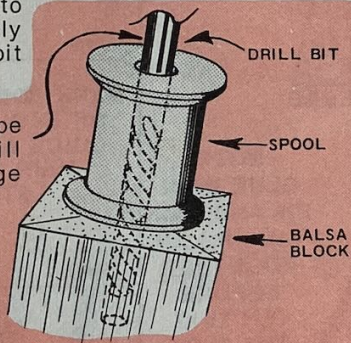

**DO NOT USE WITH ELECTRIC DRILL**

## PLASTIC SHEET PROTECTS

Polyethylene "Drop cloth" or "Tarp" sold packaged or in rolls in hardware stores is suggested by Jim Levin, Cincinnati, Ohio. White glue won't stick to the material. . . plans may be read through it while being protected. . . table cloths (and Mom's nerves also) will be protected.

## — QUICKIES —

If you tend to misplace the interlock key of the Electro Launch, tie a 3 foot length of streamer material to it—says Mark Brandes of Jacksonville, Florida.

Lids from empty dope bottles make excellent replacement caps for engine mailing tubes—suggestion of David Snavely of Arlington, Texas.

Easy cleaning and prevention of rust is the result of rubbing a film of ordinary bar soap on your blast deflector before launches, according to John Buchanan of Oronogo, Mo.

Sand a bevel onto the front edge of the coupler in a booster stage so the sections will assemble easily. A suggestion by Bradford Sewart of Baltic, Conn.

## PAPER CUPS FOR ROCKET HOLDER

Suggested by Bill Rouser of Indialantic, Fla. From the variety of paper cup sizes available one can make a support for any sized bird.

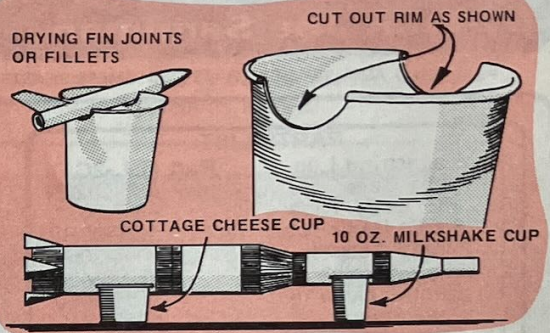

## ROD-LOCK FOR TILT-A-PAD

Now you may remove and replace the rod in your Tilt-A-Pad without thought of wear thanks to Melville G. Boyd of Midwest City, Okla.

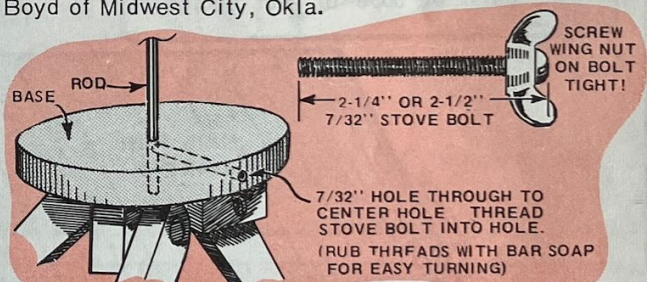

## TAB YOUR CATALOG...

... suggests Jim Bernard of So. Hadley, Mass. Available at most stationery counters, lick-to-stick tabs can make those most used pages easy to turn to. . . or. . . you can make 'em like so.



## PAINT CORNER

### DECORATING TAPE DOUBLES AS REINFORCING MATERIAL

A strip of decorating tape around the front end of a body tube serves as a reinforcement against lip damage.

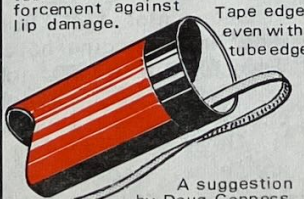

A suggestion by Doug Coppess, of Greenville, Ohio.

### MODEL HOLDER FOR PAINTING

Roll up a few pages of newspaper as shown—inserted in the engine tube it serves as a holder for spray or brush painting.



Suggested by Lyndle Schenck Kannapolis, N.C.

# Estes Industries Rocket Plan #67

## BLUE LIGHTNING

AUGUST, 1969

DESIGN OF THE MONTH WINNER

By Ivan Joe Sandman Lewistown, Mont.

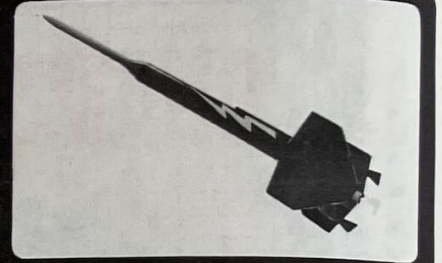

PUBLISHED AS A SERVICE TO ITS CUSTOMERS BY ESTES INDUSTRIES, INC., BOX 227, PENROSE, CO. 81240

© ESTES INDUSTRIES 1970

### PARTS LIST

Quantity	Part Name	Part #
1	Launching Lug	#LL-2C
1	Nose Cone	#BNC-20N
1	18" Body Tube	#BT-60
1	8.65" Body Tube	#BT-20B
1	Balsa Adapter	#TA-2060
2	Sheets Balsa Stock	#BFS-40
1	Engine Mount Kit	#EH-2060
1	Snap Swivel	#SV-12
1	Screw Eye	#SE-1
1	Shock Cord	#SC-2
1	Parachute Kit 24"	#PK-24
1	Engine Holder	#EH-2

In addition to the parts listed above you will need white glue, scissors, masking tape, a model knife, sandpaper, a brush, paint or dope in your choice of colors.

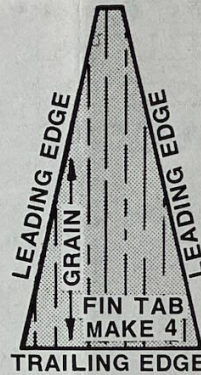

FIN

↑ ↑

TUBE MARKING GUIDE

---

FIN

MARK BODY TUBE AT BOTTOM OF EACH NOTCH - REMOVE GUIDE AND CONNECT EACH PAIR OF MARKS WITH A STRAIGHT LINE.

---

FIN

TAPING TOGETHER BEFORE CUTTING OUT SLOT FOR FIN TAB.

---

FIN

TAPING TOGETHER BEFORE CUTTING OUT SLOT FOR FIN TAB.

---

FIN

MARKING GUIDE

---

FIN

NOTCHES

---

FIN

GUIDE IS STRAIGHT WHEN ARROWS LINE UP

↓ ↓

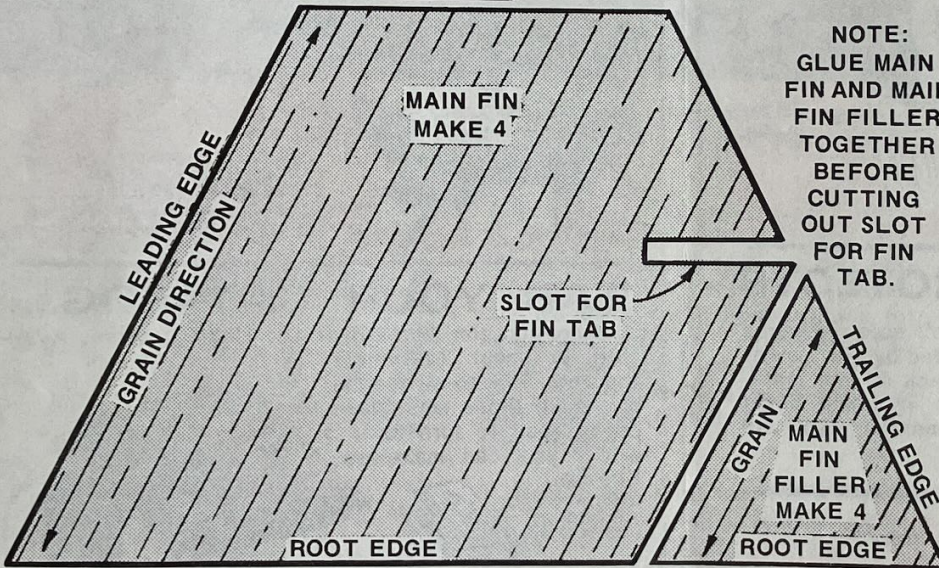

NOTE: GLUE MAIN FIN AND MAIN FIN FILLER TOGETHER BEFORE CUTTING OUT SLOT FOR FIN TAB.

### ENGINE MOUNT ASSEMBLY

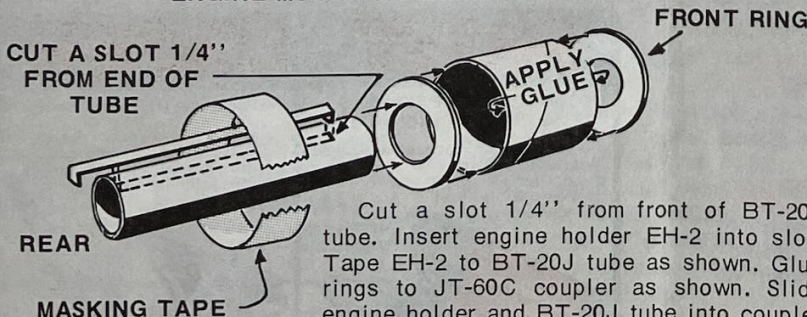

Cut a slot 1/4" from front of BT-20J tube. Insert engine holder EH-2 into slot. Tape EH-2 to BT-20J tube as shown. Glue rings to JT-60C coupler as shown. Slide engine holder and BT-20J tube into coupler. It will be in place when front ring and slot are even. Apply a good fillet of glue around both ring tube joints.

### ATTACH SHOCK CORD TO ANCHOR AS SHOWN

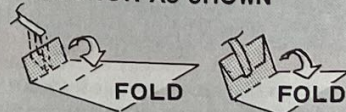

APPLY GLUE AND POSITION IN TUBE

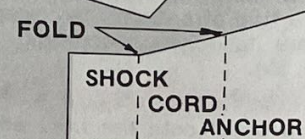

PATTERN ONLY

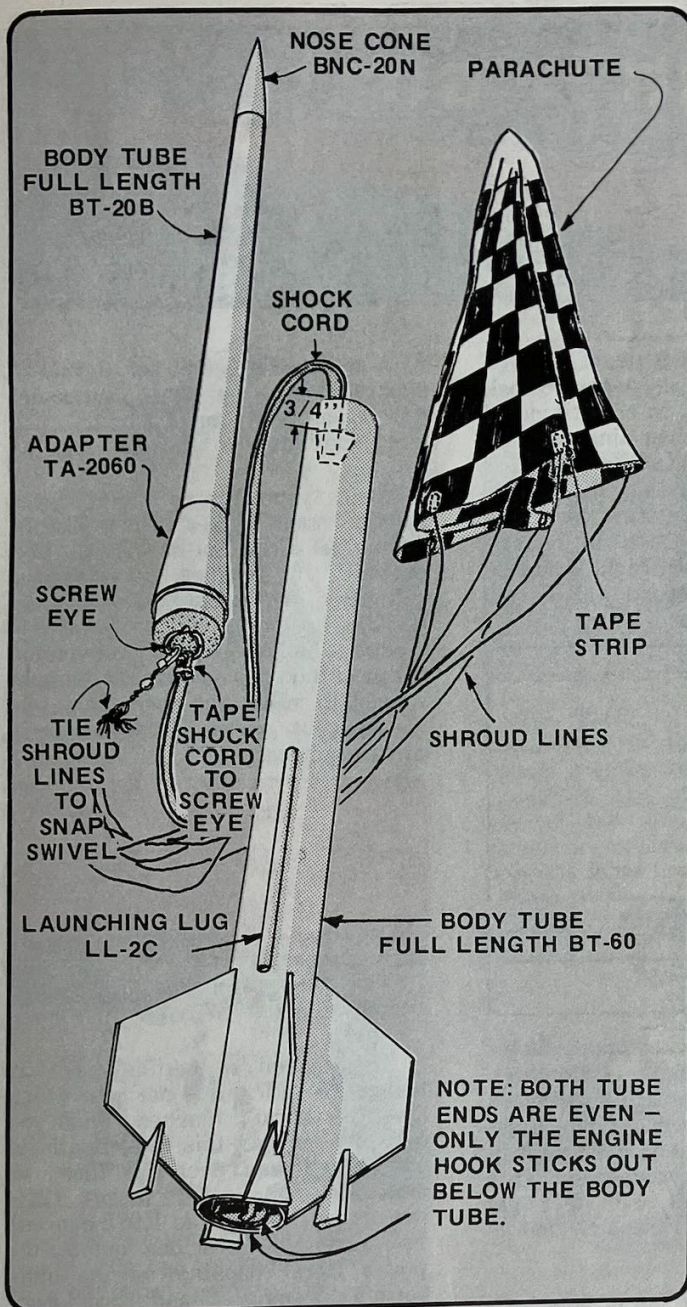

NOTE: BOTH TUBE ENDS ARE EVEN - ONLY THE ENGINE HOOK STICKS OUT BELOW THE BODY TUBE.

Attach screw eye to adapter as shown in the technical section of your ESTES Model Rocket Catalog. Mark BT-60 tube for fins using tube marking guide. Insert engine holder unit in BT-60 tube as shown below.

Copy fin and fin tab pattern onto BFS-40, cut out, sand all leading and trailing edges round.

Attach fins, fin tabs, and launching lug as shown below.

Glue adapter to BT-20B tube and insert nose cone. Do not glue nose cone in if payload is desired.

Attach recovery system as shown.

### INSTALL ENGINE MOUNT

Apply a film of glue inside the BT-60 tube as shown below. Slide engine holder into place. Engine holder will be in place when BT-20J tube is flush with rear of BT-60 tube. Fillet engine mount assembly to inside of BT-60 tube.

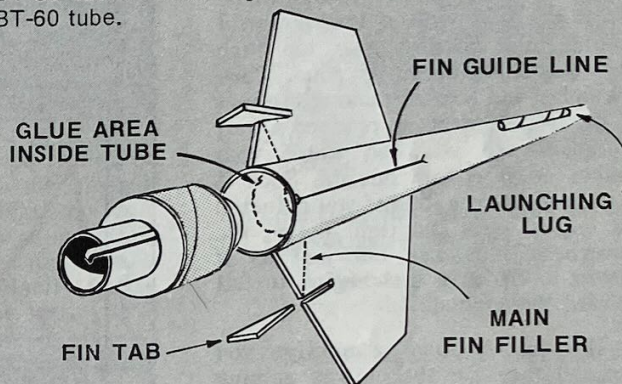

### CENTER LAUNCHING LUG BETWEEN FINS

ATTACH FINS AT 90° ANGLES FROM EACH OTHER

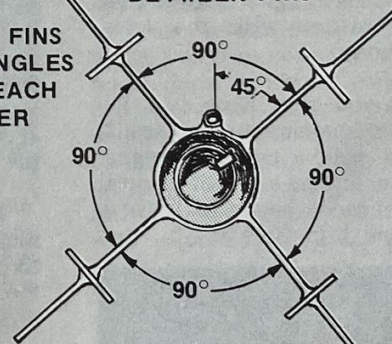

APPLY GLUE FILLETS TO FIN ROOTS, TAB JOINTS, AND LAUNCHING LUGS

### SPECIFICATIONS

LENGTH.....	31.5"
FIN SPAN.....	7.6"
BODY DIAMETER.....	1.6"
WEIGHT.....	3.25 oz.

### RECOVERY GEAR: USE A: 24" PARACHUTE FOR CALM WEATHER

In winds over 10 mph use a 12" 'chute. For duration drifts use two 24" 'chutes.

When flying the Blue Lightning use 7 squares of flameproof wadding.

Suggested colors for the "Blue Lightning" are two shades of Blue.

### RECOMMENDED ENGINES

A8-3, B6-4 AND C6-5  
USE AN A8-3 FOR FIRST FLIGHT

Sleek design and generous size make the Blue Lightning an excellent sport or demonstration model. Ivan states the fin tabs were designed to absorb landing shock but also provide ample support while the bird is on display.

# HOW FAST DID IT GO?

by Robert L. Cannon

A brief hiss of escaping gases, a blur of motion, and the rocket streaks skyward. Your model rocket really moves.

Have you ever stopped to wonder just how fast your model rocket travels? You have noticed that a large, relatively heavy rocket takes off fairly fast with a less-powerful engine, but doesn't rise too high before the propellant is gone. Then the delay and smoke tracking element of the engine starts to produce a trail of smoke so you can watch your rocket as it coasts upward. Soon it coasts to apogee, and if you selected an engine with the right delay, the parachute blossoms out just as it starts to tip over and begins to fall toward the ground.

If you observed carefully, you noticed that the rocket was gaining speed very quickly as it started on its flight into the sky. When you launched a small, relatively light-weight rocket with a powerful engine, you noticed that it took off very fast. Of course it went much higher than the heavy rocket with the less-powerful engine.

In fact, you may have had the experience of launching a very small, light rocket with a powerful engine and actually losing sight of it until the delay element began to leave a smoke trail high in the sky.

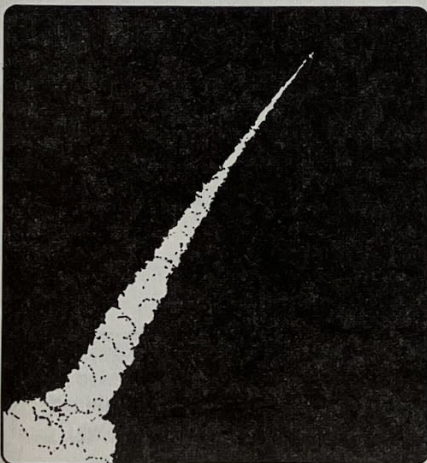

To produce enough thrust to move a tiny rocket, as an Astron Streak with a C6-7 engine, to an altitude of 1700 feet in less than nine seconds (1.70 seconds of thrusting flight and 7 seconds of coasting flight, the small rocket's engine must cause the rocket to move very fast. An average speed for this upward flight would be 195.4 feet per second (1700 feet divided by 8.7 seconds).

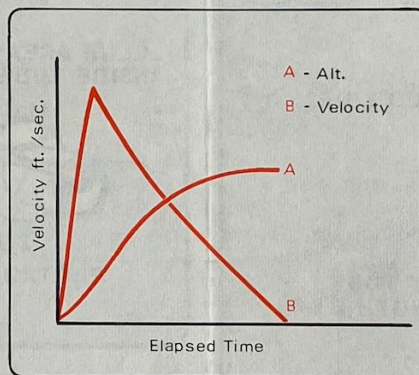

Actually, the rocket moves faster and faster as the engine is thrusting. At the end of this thrusting portion of the flight, (1.7 seconds into flight time from liftoff), the model rocket is traveling at its maximum speed. This maximum speed is 670 feet per second, or about 3.5 times as fast as the average speed.

After the propellant is gone, the rocket is moving upward without a thrust force pushing it on up, so the force of gravity acts to slow the rocket down.

Your rocket, while moving at its maximum velocity of 670 feet per second, is traveling very fast. To convert this speed into the method of expressing speed with which you are more familiar, try to estimate this speed expressed as miles per hour and put your answer in the space below.

A speed of 670 feet per second is about 456 miles per hour. Your model rocket was really moving by the time the propellant was all gone.

When you fly a larger, much heavier model rocket with a smaller engine, as a Big Bertha with an A5-2 engine, it reaches a maximum velocity of 84 feet per second during its 2.8 second flight to parachute ejection. Multiply by the conversion factor of 0.68 to convert from feet per second to miles per hour. What was the maximum speed of this rocket in miles per hour?

84 feet per second = about \_\_\_\_\_ m.p.h.

The rocket reached a maximum speed of about 57 miles per hour.

This speed is certainly not as fast as the 457 miles per hour which the other rocket reached. When you consider the fact this rocket with its engine weighed over 2.5 times as much as the other rocket (2.84 ounces as compared to 1.075 ounces), had an engine with one quarter the power (total impulse) of the other rocket's engine, and had much greater drag, you should not be surprised that the heavy rocket only reached a speed of about one-eighth as great as that reached by the smaller rocket.

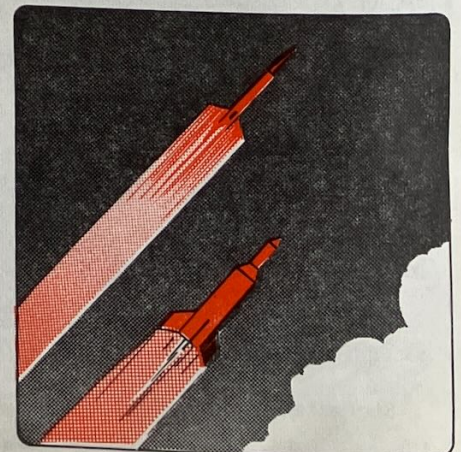

670 feet per second = \_\_\_\_\_ m.p.h.



A jet plane traveling at the speed of sound near sea level goes about 750 miles per hour. This is about 1100 feet per second. A speed of 750 miles per hour is quite impressive. For example, a plane traveling at this speed could travel from New York City to St. Louis, Missouri, or from Denver, Colorado to Saskatoon, Saskatchewan, Canada, in one hour.

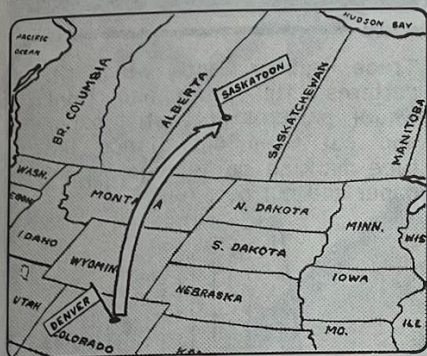

We don't really think of this as being very far, but 750 miles, the distance a plane can go in one hour, is equal to going the distance all the way around a typical city block 3,300 times in one hour.



A man walking or marching at a steady pace can average about three miles per hour. To convert this speed to feet per second, multiply the number of miles per hour by 1.47. Express this speed in feet per second.

3 miles per hour = \_\_\_\_\_ feet per second

A speed of three miles per hour equals 4.41 feet per second.

This speed isn't very fast, but it is in the range of speed with which you have personal contact. A very fast racer can run 100 yards in ten seconds. This is how many feet per second?

100 yards in 10 seconds = \_\_\_\_\_ feet per second

This speed is 30 feet per second (100 yards X 3 feet = 30 feet per second). This is a very fast speed for a man to move under his own power. How fast is this in miles per hour?

30 feet per second = \_\_\_\_\_ miles per hour

This speed is about 20 miles per hour. This is one of the fastest speeds a human can achieve on land through the use of his own muscles. One of the slowest model rocket launches produces a velocity which is nearly three times this fast.

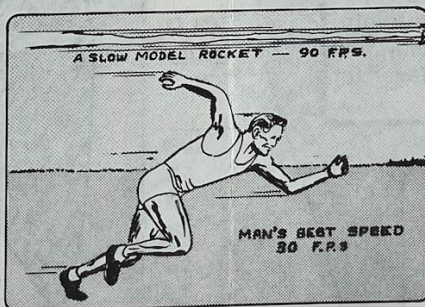

Satellites traveling around Earth vary in velocity from about 4.85 miles per second (at an altitude of 100 miles) to about 191 miles per hour (in synchronous or 24-hour orbit). These speeds are so fast that it is difficult to realize how fast they really are. Remembering that a walking man can travel at a velocity of 4.41 feet per second, a fast runner can sprint (dash) at 30 feet per second for short periods, a model rocket can move at 670 feet per second, a jet plane traveling at the speed of sound goes 1100 feet per second, calculate the speed in feet per second for a satellite orbiting Earth at an altitude of 100 miles.

4.85 miles per second = \_\_\_\_\_ feet per second

To convert miles per second to miles per hour, multiply the speed in miles per second by 3600 (the number of seconds in an hour).

4.85 miles per second X 3600 seconds per hour = 17,460 miles per hour.

17,460 miles per hour X 1.47 = 25,666.2 feet per second.

This speed, about 25,700 feet per second is over twenty-two times the speed of a jet plane flying at the speed of sound.

To attempt to give you a better understanding for these speeds, realize that it takes you about--

- 68 seconds to walk the length of an average city block (300 ft.),
- 10 seconds to run the same distance,
- 0.45 seconds for a "hot" model rocket to go that far,
- 0.27 seconds for a jet plane flying at the speed of sound, or
- 0.01 seconds for a satellite in an orbit of 100 miles altitude to go that far.

These numbers are given, not to make you feel that model rockets go slow (they don't), but to help you understand how their speeds compare to other velocities of objects with which you may someday work. If you really have a strong enough desire and develop within yourself the necessary skills through study and careful practice, maybe you will someday be working with planes, full-scale rockets, and satellites with velocities in this range. Model rocketry is one way to practice elements of some of the skills you will need to develop to become an aerospace scientist.

TABLE OF SPEEDS	
Feet per second	Object
4.41 (walking) 30 (short sprint)	A man
670	A model rocket
1100	A jet plane
25,666.2	Earth orbiting satellite (100 miles)

# Estes Industries Rocket Plan No. 69

# CONSTRICTOR

NOV. '69

DESIGN OF THE MONTH WINNER

By Randy Gibson, Cottondale, Alabama

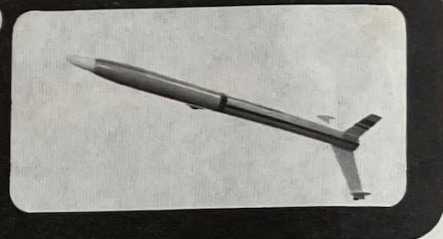

## PARTS LIST

- |   |               |          |   |                     |          |
|---|---------------|----------|---|---------------------|----------|
| 1 | Nose Cone     | #BNC-20B | 1 | Engine Mount Kit    | #EH-2055 |
| 1 | Tail Cone     | #BTC-55Z | 5 | Centering Ring      | #RA-2055 |
| 2 | Sheet Balsa   | #BFS-30  | 2 | Launching Lug       | #LL-2A   |
| 1 | Body Tube     | #BT-55   | 1 | Shock Cord          | #SC-1    |
| 1 | Body Tube     | #BT-20B  | 2 | Short Engine Holder | #EH-3    |
| 1 | Parachute Kit | #PK-12   | 2 | Tape Hinges         | #TH-1    |

In addition to the parts above you will need a bottle of white glue, ruler, scissors, model knife, ballpoint pen, piece of cardboard (for patterns). Also needed is medium and fine sandpaper, sanding sealer, paint or dope and decals of your choice.

Trace rudder and wing fin patterns onto stiff paper and cut them out. Trace the tube marking guide onto typing paper and cut out.

A non-symmetrical fin layout and external shock cord mounting is the first clue that this bird is different. . . You examine that special nose cone set up and it becomes clear that this bird has a new type of 'chute release. You may find the flat recovery technique a real fin-saver for a bird of your own design.

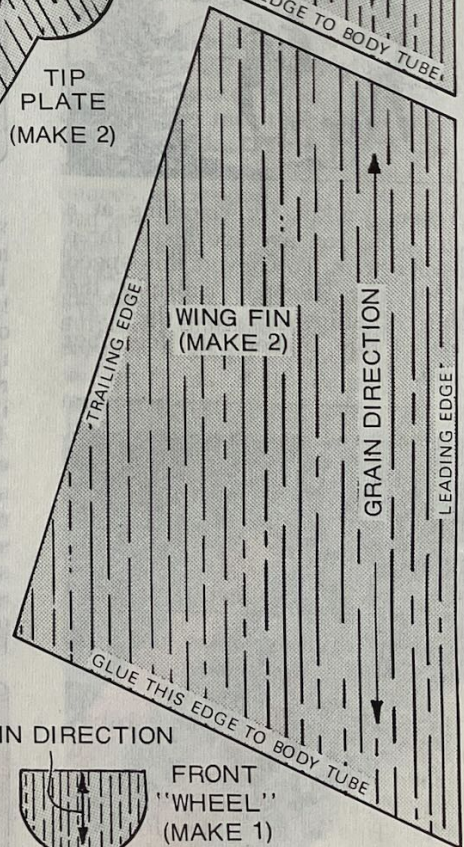
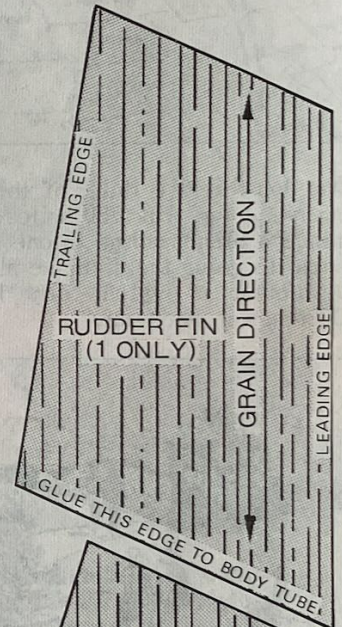
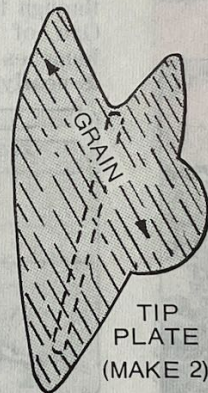
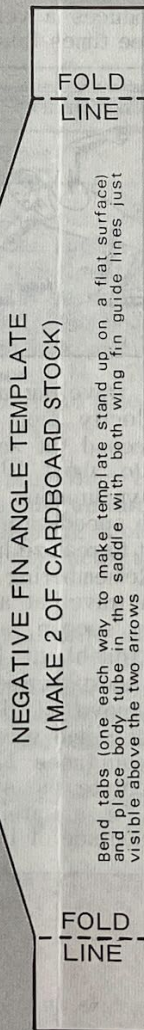
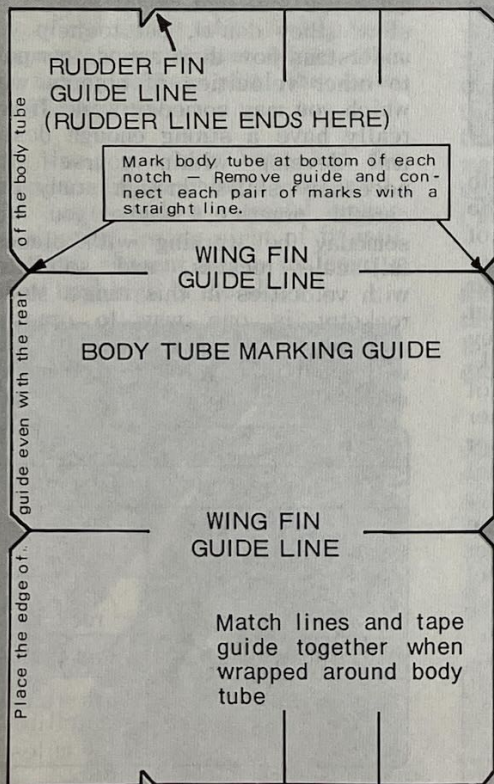

**1** Assemble engine mount kit according to the instructions which came with the kit

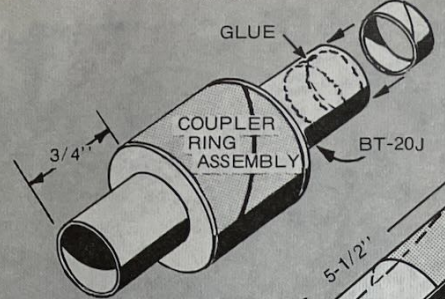

**2** Assemble parachute as instructed in kit. Tie shroud lines to free end of shock cord

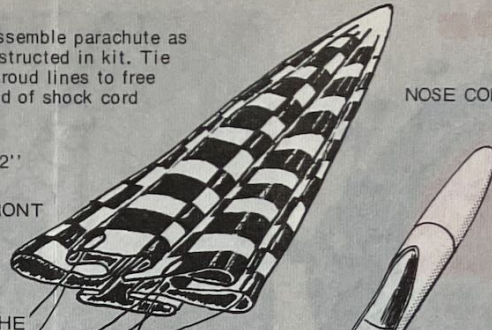

**3** Prepare the parachute ejection system tube, cut out the section as shown. Glue the BNC-20B nose cone into the front end of tube.

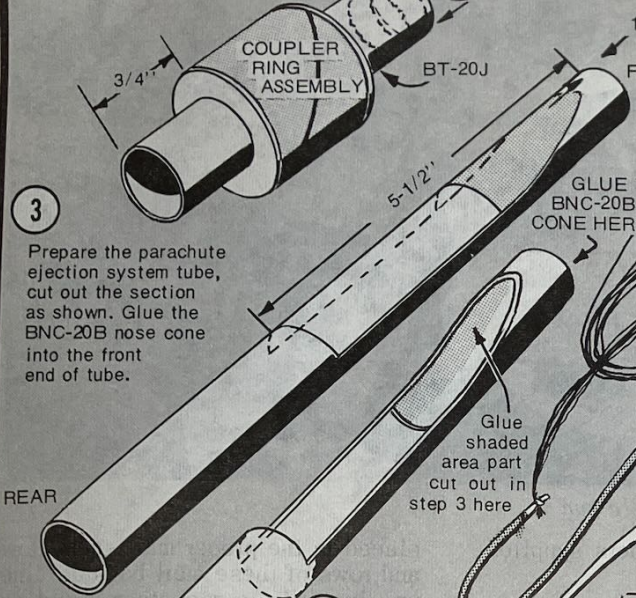

**4** Glue 5 RA-2055 centering rings together as shown

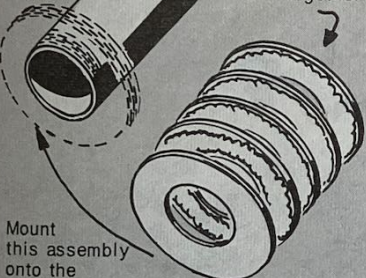

ONE OF 2 PIECES OF ADHESIVE-BACKED PAPER

**5** ONE OF 2 SHORT ENGINE HOLDERS  
Engine holders serve as bottom stop for the parachute ejection system.

**5A** 1/2" x 2-1/2" piece of tape hinge or PFM-1 serves to cover and hold engine hooks in place in this function

Mount this assembly onto the rear end of the tube. Allow a 1/16" length of the tube to stick through for a glue fillet to be applied.

**6** Shock cord mount glues to outside of body tube at point of C/G (check your model for exact C/G as construction differs). Align the mount directly ahead of the rudder fin.

RECOMMENDED ENGINES  
A8-3, B6-4, C6-5

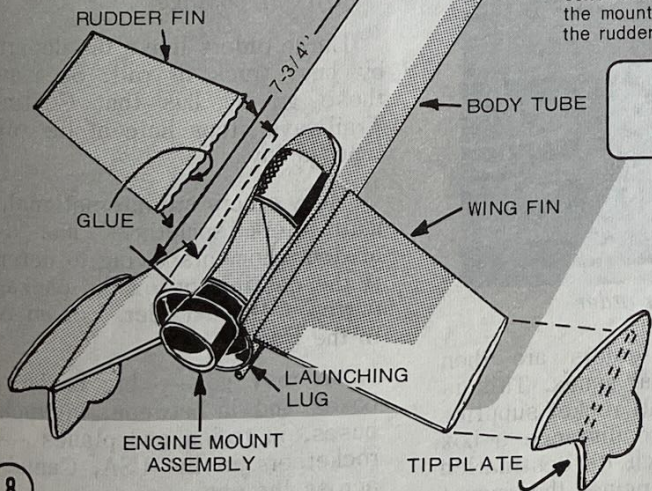

**8** Fully extend 'chute tube. Pack 1 square of wadding into tube. Form a 'spike' with 'chute, fold into 'S' shape and slip into tube until 3/4 of it is out of view within the nose section. Gather ejection lines and lay them back and forth in the remaining ejection tube area - do the same with the slack in the shock cord. Remove any twist in the shock cord so it lays smooth on this body tube and over the adapter cone. Carefully push the ejection tube in until it seats against the bottom stop.

Trace this template onto typing paper and cut out. Place template on BT-20 'chute tube 1/2" from one end - tapered end to front. Mark around template and cut this portion from tube. Now cut off the tapered end (mark cut line) of the piece just removed from the tube and glue this piece in the 'chute tube to act as ejection ramp. (See step 3.)

PLEASE READ INSTRUCTIONS



CUT LINE

SEE "WHEEL" DETAIL BELOW

FRONT LAUNCHING LUG  
"WHEEL" DETAIL

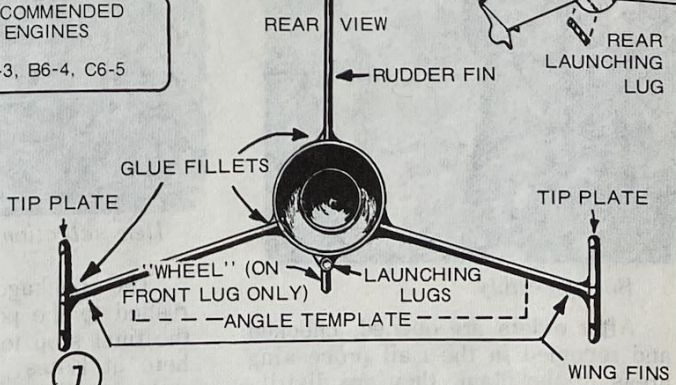
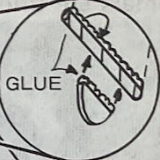

Dotted line shows resting position of body tube in the fin angle template (before tip plates, launch lugs and front wheel are added) to get the correct angle to the wing fins. Align fin guide lines as directed on the angle template. Apply a line of glue to the root edge of a wing fin - place this edge against the body tube over a guide line and allow the flat side of the fin to rest on the angle template. Repeat with the other wing fin... make sure both root edges are parallel to the centerline of the body tube. Allow to dry completely before moving assembly from template.

## FOCUS on



## SHIPPING

"More blast deflector plates at station 5."

"TR-6, station 2."

"FSK-4 at 8."

The shippers' calls for more supplies are heard above the racket of nearby staple guns. Stockers rush to refill empty shelves. The rustle of papers, the sound of voices and the thud of boxes are background noises in the Shipping department as orders are filled and shipped.



*Box assembly*

After orders are opened, checked and recorded in the mail processing areas of the plant, they are distributed to ten shipping stations. Eight of these booths are designed to handle small orders, while two are used to fill large orders. Each station is lined with bins and shelves containing model rocket kits and supplies.



*Closing box with staple gun*

Stockers keep the shippers supplied with materials.

As the shipper gets an order, she gathers together the items, boxes them, seals the boxes with an automatic over-head stapler and places an address label on the package. During the busy seasons "back-packers" work behind the shippers, checking and boxing the assembled orders.



*Item selection for order*

The packaged orders are then rushed to the postal annex. This is the final stop for all rocket supplies here at Estes. The distance a box must travel to reach its destination and its weight determines the amount of postage required. Levers on the stamp machine are set for the postage needed, a button is pushed setting the machine into action and a stamp bearing the words "Model Rocket Capital of the World" is ejected. The sticky stamp is slapped on the package which in turn is

placed in the proper mail sack. Rows and rows of these mail bags are lined up—just like a rocketeer would see in his local Post Office. When the bags are filled, they are stacked for the regular postal trucks to pick up.



*Affixing postage*

Large orders leave the department by bus, truck or rail. So many of these go by bus that Continental Trailways stops here at the plant 5 times a day.

Many orders are international. The mail clerk sometimes has a few anxious moments trying to determine if the destination on the package is Africa, "Down Under," or an island in the Pacific.

So they go — big boxes, little boxes and in between; in trucks and buses, in trains and planes — to rocketeers in the USA, Canada and across the sea.

