

# MODEL ROCKETRY

47755  
AUGUST 1971  
75¢

THE JOURNAL OF MINIATURE ASTRONAUTICS

"BUTTERFLY II"  
COMPETITION HORNET BIG

Apollo  
Earth  
Orbital  
Workshop

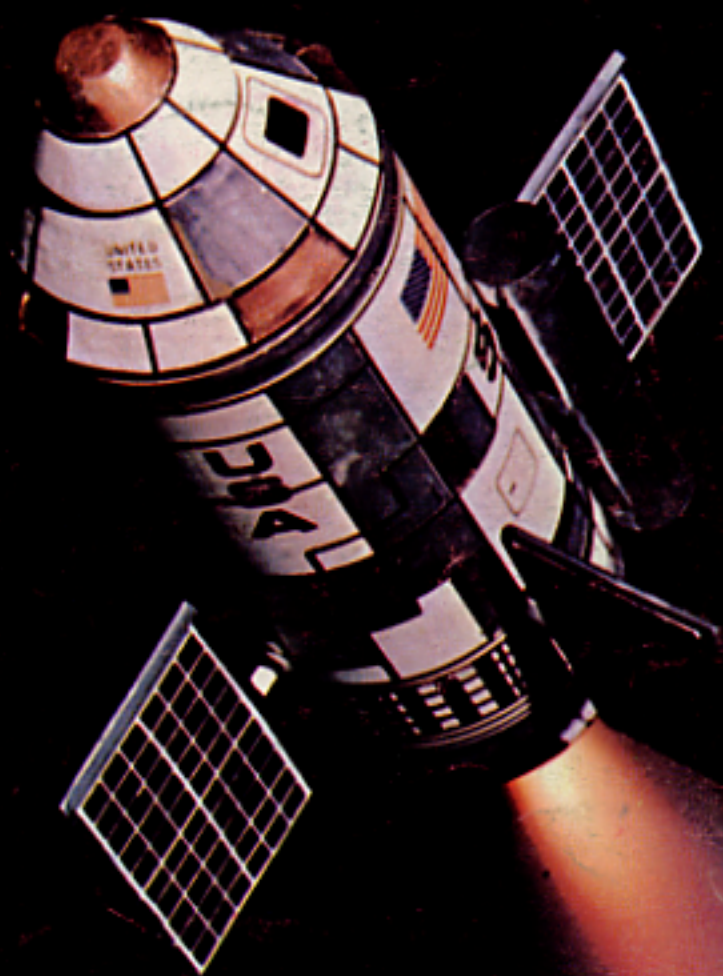



**Centuri**

# POWER TESTED!

Our engineer/designers are tough on new rockets — each concept must undergo a series of rigorous power-tests before it can qualify for the CENTURI emblem!

Only the toughest, the best performers make it! Write for our complete catalog of power-tested high-performance FLYING ROCKETS.

CENTURI ENGINEERING COMPANY /P.O. Box 1988, Dept. M-81/Phoenix, Arizona 85001

# Model Rocketry

Volume III, No. 10  
August 1971

Editor and Publisher	George J. Flynn
Managing Editor	Gordon K. Mandell
Technical Editor	Douglas Malewicki
Assistant Editor	Robert B. Singer
Assistant Editor	Robert Parks
Business Manager	Thomas T. Milkie
Distribution Manager	Steven Glines
Technical Correspondent	George J. Caporaso

## Cover Photo

This month's cover shows a model Apollo Earth Orbiting Workshop. Complete plans for this rocket, designed by Ronnie Cramer, begin on page 10. (Cover photo by George Flynn.)

## From the Editor

The singlemost important consideration for rocketeers who wish to compete in regional and national model rocket contests is quickly becoming the cost of housing and food at these weekend events. Conventions and Record Trials are suffering from this same problem of excluding those interested rocketeers who simply cannot afford the cost of attending. Some costs, of course, are unavoidable. Trophies, sanctioning fees, and range equipment all cost money, and each participant must share in these costs. However fancy motels, expensive restaurants, and other "conveniences" are not essential to a successful model rocket competition or convention. In fact, they may discourage attendance by those rocketeers who simply cannot afford the expense.

At least one club has recognized this problem and attempted to solve it. The NARCAS Section of the NAR has, for two years, sponsored a very successful Record Trials without placing an undue financial burden on the participants. Both years the NARCAS Annual Record Trials (NART) has been held at an Army base, and housing has been provided on the base at a very small cost to the rocketeers. Similar arrangements to use barracks space to house contestants have been made in the past at several other military sites. Other clubs planning contests or conventions of longer than one day duration would do well to explore this possibility.

Other alternatives to expensive contestant housing at motels also deserve to be explored. Last year Montreal's Atmospheric Rocket Research Association made arrangements for housing convention participants at the YMCA. The rooming fee was much lower than that charged by Montreal's many motels, and this allowed some rocketeers who could not otherwise attend to participate in Canada's first modroc convention. Another Canadian club chose to make inexpensive housing available for contestants at the Alberta regional by

(Continued on page 46)

**Apollo Earth Orbiting Workshop** 10  
Construction plans for a flying semi-scale earth orbiting laboratory of the type NASA plans to fly in the Mid-70's.

*Designed by Ronnie Cramer*

**NART-II Record Trials** 14

An on-the-scene report from the NART-II Record Trials where Condor and Hornet Rocket/Glider were being flown for the first time.

*by George Flynn*

**Flight Test: Two New Modroc Books** 19

*by Jon H. Randolph*

**Model Rocket Drag Reduction by Boat-tailing** 20

Smoke tunnel and wind tunnel verification of the drag reduction caused by "boat-tailing" your models.

*by George Pantalos*

**The "Butterfly II" Boost/Glider** 23

Complete plans for a built-up wing Hornet B/G which turned in 196 seconds on its first test flight.

*by Tom Milkie*

**Making Paper Fins for Your Scale Birds** 28

Step-by-step details on how to make strong, easy to finish, paper fins for Nikes and other scale models.

*by George Flynn*

**The Perihelion 4** 32

Plans for a high-performance egglofter design using all standard parts requiring no difficult turning or fabrication.

*Designed by Larry Shenosky*

**Pacific Area Regional Report** 35

A contest report from the only big meet of the year held on the West Coast.

*by Mike Pass*

**Club Corner: Running a Contest** 39

*by Bob Mullane*

## Regular Features

Letters to the Editor	2	Modroc Calendar	30
From the Launching Pad	6	Reader Design	38
New Product Notes	13	Club Notes	48

**The Model Rocketeer (National Association of Rocketry)** 40

**Update Canada** 31

Worldwide newsstand distribution by Kable News Company, 777 Third Ave., New York NY 10027. Hobby shop distribution by Kalmbach Publishing Co., 1027 North Seventh Street, Milwaukee, Wisconsin 53233.

Second class postage paid at Boston, MA and at additional mailing offices. Model Rocketry magazine is published monthly by Model Rocketry, Inc., 639 Mass. Ave., Cambridge, MA 02139.

Subscription Rates: US and Canada \$7.00 per year \$4.00 for six months, 75 cents for single copy; Foreign \$13.00 per year, \$7.00 for 6 months, \$1.00 for single copy. For change of address please notify Subscription Department, Model Rocketry, Box 214, Astor Street Station, Boston, MA 02123 at least six weeks in advance. Include former address of mailing label with the new address.

Material submitted for publication should be accompanied by a self-addressed, stamped envelope if return is desired. Model Rocketry can assume no responsibility for material lost or damaged, however care will be exercised in handling. Articles accepted for publication will be paid at the rates current at the time of publication. Letters, contest information, news, announcements, ect. are assumed to be submitted gratis.

Undeliverable copies, notices of change of address, subscriptions, and material submitted to Model Rocketry, Box 214, Astor Street Station, Boston, MA 02123.

Printed in USA

© Copyright 1971 by Model Rocketry, Inc.

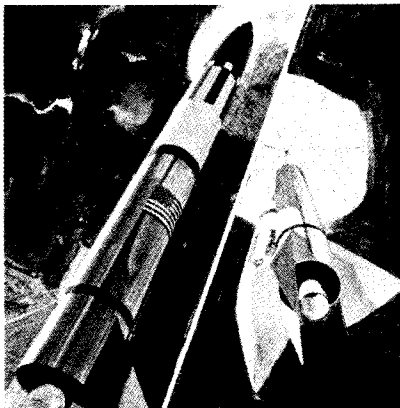

Shoot for more fun in '71 with "Valkyrie," the model rocket that's ready to go — complete with launcher and fuel. It's all there, nothing else to buy! Fun and easy to assemble, flights up to 1,000 feet, with parachute recovery. Safe, cool rocket fuel. Shipped postpaid \$15.95, or send 25c for catalog, (included free with order).

# VALKYRIE

# 29

**VASHON INDUSTRIES INC.**

Dept. 161, Box 309,  
Vashon, Washington 98070

GET IN THE WINNER'S CIRCLE

fly  
COMPETITION  
MODEL ROCKETS  
BOX 7022  
ALEXANDRIA, VA.  
22307

## HOBBY CATALOGS

FROM THE WORLD'S  
LEADING HOBBY HOUSE

AIRPLANES	\$1.50
RAILROAD	1.75
SHIPS (Wood)	1.00
MILITARY	1.00
CRAFTS	1.00
RACEWAY, SCIENCE & ROCKETRY	1.00

Dealer Inquiries Invited  
314 FIFTH AVENUE  
N. Y., N. Y. 10001  
2072 FRONT STREET  
E. MEADOW, L. I., N. Y.  
197 Woodbridge Center  
Woodbridge, N. J.  
512 MILBURN AVENUE  
MILBURN, N. J.

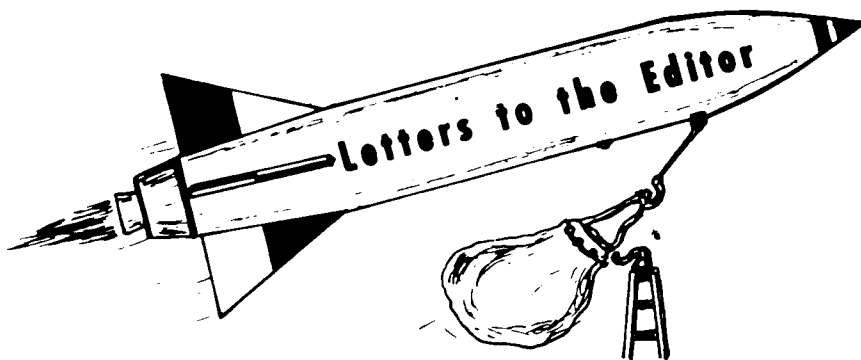

### Low Drag Launch Lugs

Instead of using straws for launch lugs on my high-performance models, I have begun using loops of thin copper wire passed through the rocket body tube. "U-shaped" loops of wire are passed through small holes in the body, the ends are bent over, and epoxied

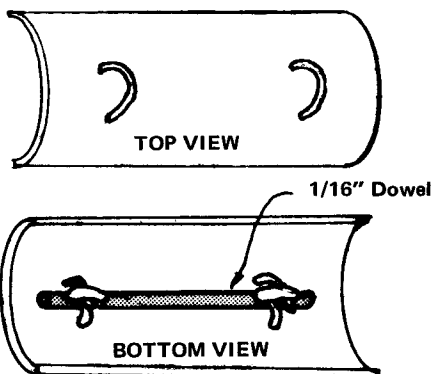

to a 1/16" dowel internal support. This system looks better, is stronger, and offers less drag than the regular launch lug.

Eric Warp  
Minden, Nebraska

### Night Launching Technique

I am intrigued by spin rate systems and flashing lights aboard rockets. If a 9 volt

battery is wired directly to a flashlight bulb, and the two are mounted in a clear payload section, the model can be tracked at night. If both ends and one half of the side wall of the payload section are covered with silver Monokote, the light emitted will be stronger in one direction than in the other.

Now, mount this payload unit on a rocket using "spin-fins," launch it at night, and the spin rate can be recorded with a camera. Use Tri-X film, and set the lens to its widest opening (f2.0 if this is available). Mount the camera on a solid tripod, and set the shutter at 1 second. The camera should be aimed so that the field of view includes the area above the expected burnout altitude of the rocket. Trigger the shutter when the rocket enters this range. What will result on the film is a record of how far the rocket traveled and how many times it spun in the second following burnout.

Peter Clay  
Eugene, Oregon

### June '71 Issue

Congratulations! The June '71 issue is the best thing that's happened since your May '69 issue. When I saw the June MRm with the big color picture of the D-Region Tomahawk at my local hobby shop, I bought it right away.

I think that this is an especially good issue. The best, in my opinion, is the article on Flow Visualization, though the D-Region

## MAIL ORDER HEADQUARTERS

**DON'T BE LEFT OUT OF AMERICA'S  
NEWEST, MOST EXCITING HOBBY!**

MODEL ROCKETRY SUPPLIES ARE AS CLOSE AS YOUR  
MAIL BOX ----

**ESTES, CENTURI, MINI-MAX, FLIGHT-  
SYSTEMS, MPC, COX, AMROC, SAI, CMR,  
SEMROC, MITS, ENERJET, VASHON,  
COUNTDOWN.... SEND 50¢ AND WE'LL MAIL  
YOU OUR LATEST CATALOG**

orange blossom hobbies, inc.  
1975 N.W. 36<sup>th</sup> STREET dept. MR  
MIAMI, FLORIDA 33142

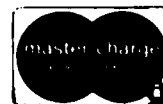

plans are a close second, with the Convention coverage, the Redwing, and Apollo 14 third. I am also glad that you made Fundamentals of Dynamic Stability a tech report, and hope to buy it soon.

I do have a gripe though. On page 10 of the issue, under the photo of the D-Region on its launcher, the caption reads: "Note that the fin to the right is painted black, while the others are red." Well, according to all scale data and photos, one fin is red and all the others are black.

Despite the gripe, I still think it is a great issue. By the way, what ever happened to *The Wayward Wind*, *Escape Tower*, and *Old Rocketeer* columns? I miss them very much.

Stephen Bryson  
Chicago, Illinois

*We are glad you like the new format, and hope MRm's appearance on national newsstands will attract many more people to the modroc hobby.*

*As for the D-Region, you're right. The caption on page 10 should read: "Note that the fin on the left is painted red, while the others are black."*

*Model Rocketry is presently introducing a number of new columns which we hope you'll enjoy. Flight Test by Jon Randolph makes its appearance in this issue. The Wayward Wind will be back as soon as Gordon Mandell completes work on the model rocket book to be published early next year by MIT Press. As for the Escape Tower, none of our editors can come up with enough oddball ideas to keep it on a monthly basis, but it will appear from time to time.*

#### Computer Programs

In the October 1970 issue of your magazine there is an article titled *Automatic Computation: CG and Drag Programs*. Not knowing too much on computer programs and very little on drag coefficients, I plugged in values for the variables and fed the drag coefficient program into an IBM computer hoping to get a value for the drag coefficient of an Aerobee 300.

Instead of getting a value, I received two error messages because of unmatched parentheses in the following lines:

**NATIONAL  
AEROSPACE  
EDUCATION  
COUNCIL**

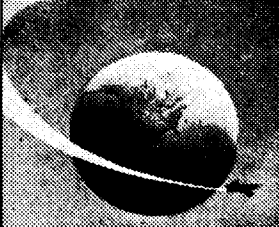

**FOR  
MEMBER-  
SHIP  
INFO  
  
WRITE  
NOW**

**806 - 15th St. NW  
Washington, D. C. 20005**

$$CDBD = (.455*(ABD/AF))/(ALOG10(RN))*2.58$$

$$CDFN = (1.327*AFN/AF)/SQRT(RN)$$

It would really be of help to me if, in an upcoming issue, you could print the corrections to this program.

Carl J. Warner  
Pottstown, PA

*The typographical errors should be corrected to read as follows:*

$$CDBD = (.455*(ABD/AF))/(ALOG10(RN))*2.58$$

$$CDFN = (1.327*(AFN/AF))/SQRT(RN)$$

*Thank you for calling these errors to our attention.*

Charles Andres

#### Closed Breech Launchers

In the March 1971 issue of *Model Rocketry* magazine, you published a letter from a Tom Wikle. He stated "I think a new contest should be flown for closed breech models only." I think that either Mr. Wikle has failed to think about what he was saying or that he has flipped his cookie. If the NAR were to segregate closed breech launchers into a new and separate contest because

**Lercari Engineering**  
P.O. BOX 90894  
WORLD WAY CENTER  
LOS ANGELES, CALIF. 90009

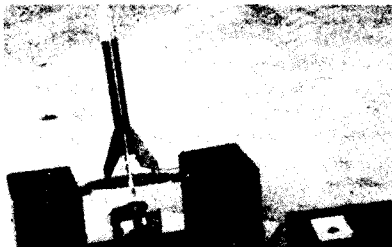

**REMOTE CONTROL LAUNCHER**

- COMPLETE LAUNCH CONTROL FROM PANEL
- TWO MOTOR DRIVEN LAUNCH ANGLES
- ACCURATE LAUNCH ANGLE METER ON PANEL
- ELEVATION LAUNCH ANGLE: +45° TO -30°
- AZIMUTH LAUNCH ANGLE: +80° TO -80°
- 25 FOOT COMMUNICATION CABLE

Send 25¢ for Brochure



P.O. BOX 424 DEPT. MR.  
WILLOUGHBY, OHIO 44094

SPACE & ROCKET MODEL KITS

We carry CENTURI,  
YAMIKA, MPC, SPACE AGE IND., REVELL,  
AURORA, LINDBERG, HAWK, VASHON IND.,  
AMT, L.M. COX — 35¢ for Catalog &  
FREE Color Print of THE APOLLO 11 Lift-Off  
— Complete Mail Order Service —

**MOON LANDING PICTURES . . .**

35 mm Apollo slides, Astronaut emblem patches, moon maps, books on space, rocket models, other gifts and souvenirs from Cape Kennedy. Write for **FREE BROCHURE** today!

**ASTROLAND — BOX 234-R  
MERRITT ISLAND, FLORIDA 32952**

CHEMISTRY, BIOLOGY, Astrology. Catalog 35 ¢. Boulevard Laboratories, Inc., 3114 East 83rd Street, Chicago, Illinois 60617.

**THE FIRST IN A SERIES OF TECHNICAL NOTES  
FOR ADVANCED ROCKETEERS**

**ADVANCED MODEL ROCKET  
AERIAL PHOTOGRAPHY**

**BY RICHARD FOX AND GEORGE FLYNN**

- ADDING A GLASS LENS TO THE ESTES CAMROC
- ADDING A HAZE FILTER
- COLOR PHOTOGRAPHY WITH THE CAMROC

**6 PAGES, WITH PHOTOGRAPHS AND DRAWINGS ONLY \$ 0.60 PPD.**

**ORDER FROM :**  
**TECH NOTES, MRm, BOX 214, ASTOR ST., BOSTON, MA 02123**

**US, USSR                      Slides, Prints**

**ROCKET PHOTOS**

Write for our complete list of color and black and white rocket photos. These slides and prints are carefully selected for use as scale substantiation data. Send \$1.00 for your choice to a Mercury-Redstone 7, USSR Vostok, or Saturn V liftoff color transparency and complete photo list. (For the list only, send 25¢ and a stamped, self-addressed envelope.)

Rocket Equipment Co.  
Dept. A, 10 Mulberry Ave.  
Garden City, N.Y. 11530

## SOLICITATION OF MATERIAL

In order to broaden and diversify its coverage of the hobby, MODEL ROCKETRY is soliciting written material from the qualified modeling public. Articles of a technical nature, research reports, articles on constructing and flying sport and competition models, scale projects, and material relating to full-scale space-flight will be considered for publication under the following terms:

1. Authors will be paid for material accepted for publication at the rate of two dollars (\$2.00) per column inch, based on a column of eight-point type thirteen picas wide, for text, six dollars fifty cents (\$6.50) for drawings, and two dollars (\$2.00) for photographs accompanying text. Payment will be made at the time of publication.

2. Material submitted must be typewritten, double-spaced, on 8½ by 11 inch paper with reasonable margins. Drawings must be done in India ink and must be neat and legible. We cannot assume responsibility for material lost or damaged in processing; however our staff will exercise care in the handling of all submitted material. An author may have his manuscript returned after use by including a stamped, self-addressed envelope with his material.

3. Our staff reserves the right to edit material in order to improve grammar and composition. Payment for material will be based on the edited copy as it appears in print. Authors will be given full credit for published material. MODEL ROCKETRY will hold copyright on all material accepted for publication.

Those wishing to submit material should send it to:

Editor,  
Model Rocketry Magazine,  
Box 214,  
Boston, Mass. 02123

## ROCKETS!!!

2000 feet plus with single and multi-stage kits. Tubes, nose cones, engines, parachutes. The new SAI Hen Grenade kit available for \$2.50 plus 35¢ postage. Amazing accelerometer kit, only \$2.00. Scale models, sport models, competition models! Same day service. Catalog \$.25. ROCKET SUPPLY CO., Dept. MR, River Edge, New Jersey 07661.

of its advantages, they would also be forced, in the name of justice, to recategorize every event into ridiculous contests. For example: Class 1 Drag Efficiency for those rockets with elliptical fins, and Class 1 Drag Efficiency for those rockets without elliptical fins. The list could continue with such things being eliminated or added as ogive nose cones, tower launchers, rearward ejection, well-finished body tubes, parachutes with spill holes, styrofoam wings, Estes engines, pop pods, etc. One can easily see that the possible combinations would literally be infinite.

But even from a more sensible point of view, the segregation of the closed breech launchers would mean the eventual end for my closed breech launcher which cost a whopping 53 dollars to design, develop, and build.

Barrett Bailey  
Anaheim, California

## ARE YOU MOVING?

Every day we get a handful of address labels back from the post office with either a change of address on them or a note that the subscriber has moved and left no address. The magazines are thrown out and just the address label is returned.

Send address changes to Change of Address, Model Rocketry, Box 214, Astor Street Station, Boston, MA 02123. Please include the address label from the last Model Rocketry you received.

## Book Review:

## TWO NEW COX ROCKETRY BOOKLETS

Reviewed by John Frankosky

The teacher planning to use model rocketry in his program will do well to investigate the current offerings of the Cox Manufacturing Company. Until recently, model rocketry was the property of the hobbyist. A measure of time and skill was needed to assemble the components for a successful flight. While involved modelers are still fabricating their own rocket components, it is now possible to purchase ready-made rockets and launching hardware so that foolproof demonstrations or scientific experiments may be planned with minimum effort.

### Handbook of Model Rocketry

The Cox Handbook of Model Rocketry is a twenty-four page booklet printed on good quality paper and it includes attractive line drawings and diagrams. It is well organized and to the point. Interesting background is provided in the form of a brief history from the ancient Chinese to Neil Armstrong's first steps on the moon. Model rocketry is explained in an extremely simple, yet thoroughly scientific manner.

The Cox line of products, which are understandably used in many of the diagrams and illustrations, should be of special interest to teachers. A great deal of reliability seems to have been designed into their products. Their igniters should eliminate corrosion of igniter clips, the chief cause of rocket misfires. While they are designed to receive a special ignition wire connector, they may be used with any ignition clips.

I must compliment the Cox Manufacturing Company who generously acknowledge that many rocket enthusiasts will want to experiment with kits and scratch-built rockets which are not part of the Cox line. Another compliment is due them for their recommendation that organizations and individuals investigate the merits of belonging to the National Association of Rocketry.

### Handbook of Flight Experiments

Douglas Malewicki is well known among experienced rocketeers and readers of Model Rocketry magazine. His highly technical articles dispel any notion that model rocketry is only for beginning modelers. Beginners, however, are very important people, and Douglas Malewicki has proven, in his Handbook of Flight Experiments, that he can speak their language. The handbook offers a program of basic experiments which the teacher, contemplating a serious study of model rocketry, will appreciate.

The design and function of Cox engines are clearly illustrated with a series of diagrams and graphs. Methods for both predicting and measuring altitude are explained. The illustrations are self-explanatory. The process of choosing the proper engine for a specific rocket, a mystery to most beginners, is graphically portrayed with a chart using typical data.

Finally, a number of interesting experiments are outlined, including results obtained from Cox engine-rocket combinations. A teacher might duplicate these experiments to gain experience and then design original experiments to solve other problems.

All effective science programs are the result of research, planning, and experience. The Cox line of materials and educational aids offers the most direct route to a successful start.

The elementary teacher wishing to excite her class with a thrilling demonstration, the junior high school or middle school teacher seeking an activity-oriented program, or the high school physics teacher wishing to investigate the dynamics of predicting flight patterns of rockets, will find that there is something for everyone in these new teaching aids offered by the Cox Manufacturing Company.

Information on both booklets is available from L.M. Cox Manufacturing Co., Dept. MR-8, Santa Ana, CA 92705.

# Be nice to your scratch-built rocket.

You've invested a lot of time and energy in your beautiful bird, not to mention some pretty tedious



Cox Solid Fuel Engine  
and Cox Safety Igniter.

work. If you want it to perform to match your craftsmanship, you won't try to fly it with second-rate engines and accessories. You'll use the best: the Cox family of model rocketry components. See them

and our line of fine, beautifully detailed, ready-to-launch model rockets at your favorite store.

**Premium Fuel:** It may be rated in newton-seconds instead of octanes, but it's still the best. Why? Because Cox Solid Fuel Engines provide a better power-to-weight ratio in the standard .69" x 2.75" casing than any other manufacturer's. Which means that you get more usable power out of a lighter package. And this year, Cox is introducing the most potent member of the line: the D8. The D8 produces 50% more power than was previously available in standard .69" x 2.75" casing. All Cox engines feature dense, highly visible tracking smoke.

**Positive Ignition:** Cox Safety Igniters\* provide fail-safe arming because the igniter is plugged into the electrical circuit prior to insertion into the engine. No "micro clips" or groping around the base of an armed rocket required.

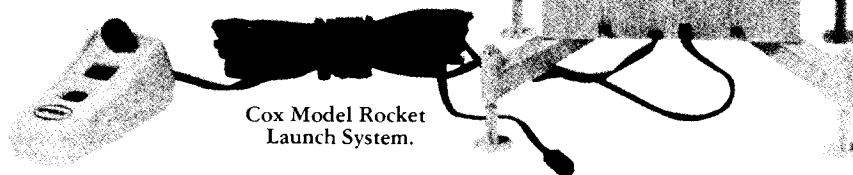

Cox Model Rocket  
Launch System.

**For a Winning Start:** The precision engineered Cox Model Rocket Launch System has adjustable legs, remote launch controller with safety key, "systems go" check light, and a safe 20 feet of

wiring. Plus additional features like a 36" launch rod, segmented for easy take-down and storage, steel blast deflector plate, and the launch base holds 8 "D" cells (not included) for dependable single engine ignition time after time.

**High Performance Requires Fast Tracking:** Cox's ready-to-use Altitude Finder is a quick, easy way to pinpoint the angle and height of your rocket's apogee. As the rocket reaches maximum height, the Altitude Finder's trigger is released, locking the direct readout gauge in position. The rocket's altitude is read directly in feet with no immediate calculations or trigonometry tables required.

**Power Brakes:** Cox Parachutes come pre-cut with shroud lines and snap-swivels attached. An elastic shock cord is included to guarantee that your favorite bird won't do a pancake landing from 800 meters. In 12", 16" and 20" diameters.



Cox  
Altitude Finder.



L. M. COX MFG. CO., INC., a subsidiary of LEISURE DYNAMICS, INC.  
1505 East Warner Ave., Dept. MR-8 Santa Ana, California 92705

\*pat. pend.

## SPECIAL OFFER!

Beautiful, full-color photograph of the Apollo 7, Saturn 1B liftoff of October, 1968

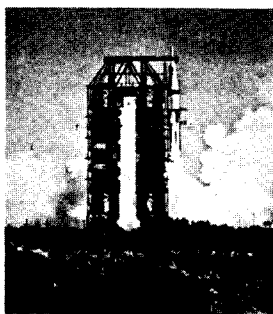

This magnificent photograph of a most historic moment in the history of spaceflight was obtained by Model Rocketry editor George Flynn from an advance position not accessible to most Kennedy Space Center visitors. Showing the moment of liftoff, this 7 by 8 inch full-color print will make an inspiring addition to the album of any space enthusiast.

\*\*\*\*\*

Full-color copies of the photograph, which is reproduced in black and white above, may be obtained by sending 50¢, or \$1.00 for 3, to:

Saturn Photo  
Model Rocketry  
Box 214  
Boston, Mass. 02123

## FROM THE

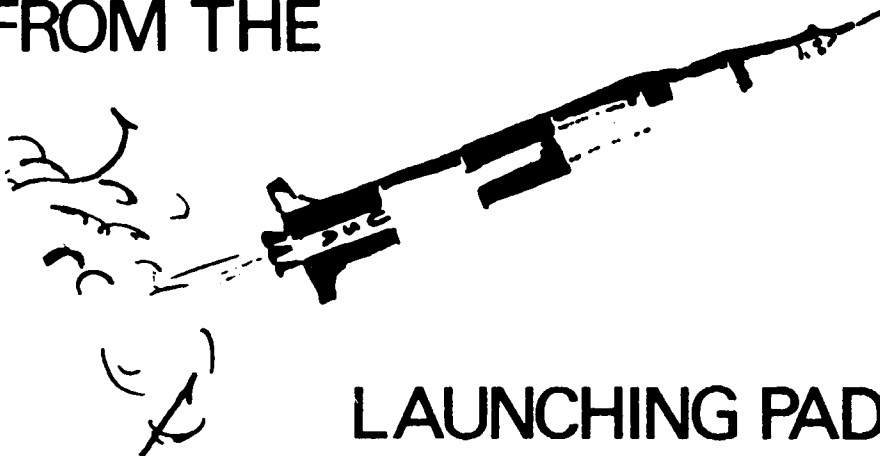

## LAUNCHING PAD

From time to time an MRM cover is so different that we get numerous letters asking how it was done. Following publication of the January 1971 issue, with the liftoff of an Aurora "2001 Space Clipper" featured on the cover, we received over a dozen letters from curious readers asking about the black background. Actually it's quite simple, we took the picture *at night*. By shooting liftoff photos at night the engine exhaust trail is enhanced, and contrast between the rocket and the background is improved.

In recent years night-flying has become increasingly popular. Use of light-flashers for night tracking has allowed the entire flight path of a night-launched model rocket to be seen and photographed. Just recently Pennsylvania's NARCAS club included a night-launched Streamer Duration competition in the NART-II contest. (See full report elsewhere in this issue.) It was quite impressive to be able to stand a quarter mile away and watch the entire flight path of a rocket against the bright star background.

But, back to this month's cover. It shows a "semi-scale" version of the NASA Space Station circling above the earth. With just a little more effort on the "simulated earth" we might even be able to convince NASA that it was real. In actuality, the photograph was shot on the roof of a dormitory in Cambridge, Massachusetts. (Since there is not enough clear area in the factory

town of Cambridge to set up for a launching, flat building roofs are sometimes used for simulated launchings.)

The photo set-up was quite unusual, since the model was mounted upside down on a C-rail (painted flat black so it would not show up), and the C-rail was fastened to an old bed frame. Bob Parks manned the ignition system, while Guppy held the simulated earth at the proper position in the "sky." The photo was taken against the black night sky with a strobe lighting the rocket, and the exposure time selected to enhance the engine exhaust. All in all, it took about three hours on each of two consecutive nights to come up with the photo on this month's cover.

Quite a while back, in the August 1970 issue, I mentioned a "Gnat Boost/Glide" contest scheduled by the MIT Model Rocket Society to evaluate the feasibility of small field contests. Gnat B/G is a boost/glide contest with power limited to 1/4A engines. Results of that first Gnat B/G attempt last September were notably unimpressive. It was a rainy afternoon, and the best flight was about seven seconds! Well, you can't expect perfection the first time a new event is flown. But the MIT club put Gnat B/G on the schedule again last May.

At this "end of the school year launch" held on May 29th the weather was much



Bob Parks prepares the ignition system as Guppy holds up the earth for the night cover photo on this month's issue of Model Rocketry.





# Home is where the heart is. Sometimes.

*But what do you do when  
that special place (or face)  
is miles and miles away?*

With a TWA Youth Passport you can fly there almost any time you get the inclination. Because you fly at discounts—on over 20 airlines in the United States (including Alaska and Hawaii), Canada and within countries overseas. And you get a whole world of fun—at fantastic savings:

- \* **1/3 off regular coach fares** on any TWA plane. On a standby basis in the continental U.S. There are no lower youth fares available!
- \* **Hotel discounts**—up to 50%—at Hilton, Sheraton and Pick hotels in the U.S. and Caribbean.
- \* **Discounts at Aspen and Vail.** On lift tickets, meals, ski lessons and rentals.
- \* **Car discounts in Europe.** On renting, buying or leasing.
- \* **Travelers Check discounts**—1/2 off on Thos. Cook and Son Travelers Cheques.
- \* **700 exclusive discounts** at hotels, shops and restaurants around the world.
- \* **Plus free TWA hospitality parties** in Paris, London and Amsterdam—every week during the summer!

To receive your Youth Passport, just mail in the coupon with your check or money order. Do it now. And follow your heart.



## Youth Passport<sup>†</sup>

**YOUTH FARE IDENTIFICATION CARD APPLICATION  
FOR AGES 12 THRU 21**

Mail to: Trans World Airlines  
P.O. Box 24C64  
Los Angeles, Calif. 90024

†Service mark owned exclusively by Trans World Airlines, Inc.

Name (please print) \_\_\_\_\_

Address \_\_\_\_\_

City \_\_\_\_\_

State \_\_\_\_\_

Zip Code \_\_\_\_\_

Date of Birth \_\_\_\_\_

Month \_\_\_\_\_

Day \_\_\_\_\_

Year \_\_\_\_\_

Hair Color \_\_\_\_\_

Eye Color \_\_\_\_\_

Male

Female

\$3.00 Fee paid by:

Check

Money Order

**MAKE CHECKS PAYABLE TO: TWA (Not refundable—DO NOT MAIL CASH)**

Signature \_\_\_\_\_

1-067-6-20339

# MODEL ROCKETRY

## magazine

THE ONLY MONTHLY MAGAZINE  
DEVOTED TO ALL ASPECTS OF  
THE HOBBY OF MODEL ROCKETRY

FEATURING ROCKET DESIGNS AND  
PLANS, REPORTS FROM CONTESTS  
AND CONVENTIONS, INSTRUMENTATION,  
MODROC NEWS, NEW PRODUCT REVIEWS....

### SCALE PLANS

Complete airframe plans to allow the construction of accurate flying models of current and historical missiles and rockets are published. Accurate, up-to-date information on the prototypes for these models is also provided. Rockets such as the Astrobee D, Nike-Smoke, and Little Joe II have been featured.

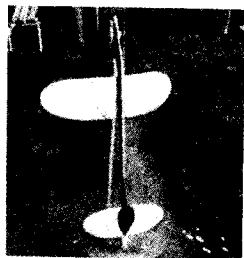

### COMPETITION DESIGNS

Complete plans for high performance, contest winning designs are published each month. Boost/glid-ers, altitude models, payload carrying models, duration models, etc. are featured. Along with these US designs, the best of European competition designs are also published.

### TECHNICAL REPORTS

Complete, up-to-date reports on various aspects of aerodynamics, stability, glider performance, etc. relevant to model rocketry. Research reports by high-school and college students, aerospace professionals, and others are published each month.

### HORIZONTAL COMPONENT OF WING LIFT



GLIDER DISTURBED  
1-70 BY TURBULENCE

... and much, much more. Articles on model rocket instrumentation — telemetry transmitters, various sensors, etc. — and suggested experiments which can be done using model rockets.

WRITE TODAY FOR SAMPLE COPY  
OR SUBSCRIBE AT SPECIAL RATES!

Mail To: MRm, Box 214, Astor Station, Boston, MA 02123

- ( ) 25 cents for sample
- ( ) \$7.00 per year (12 issues)
- ( ) \$13.00 for 2 years (24 issues)

NAME: \_\_\_\_\_

ADDRESS: \_\_\_\_\_

CITY: \_\_\_\_\_ STATE: \_\_\_\_\_ ZIP: \_\_\_\_\_

DON'T MISS AN ISSUE

SUBSCRIBE TODAY!!!

more cooperative. It was a bright, clear day with winds of only a few miles per hour. There were four entries in the Gnat event, and one of them turned in a performance topping some of the winning Hornets at recent contests. The team of Bernard Biales and Len Feshkins flew an "ejection flexwing" glider which Bernard has been working on for almost five years. The glider has polyethylene wings which are folded out by rubber bands. The stabilizer and fin are also folded flat

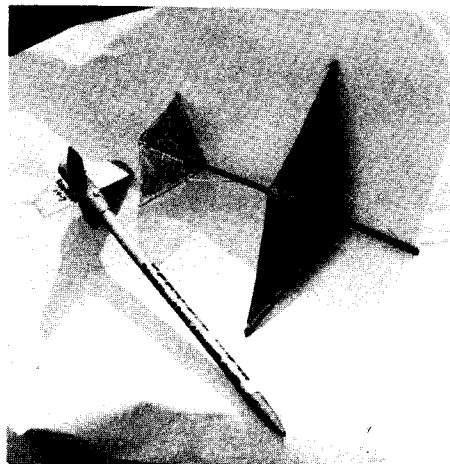

against the boom to allow the glider to fit inside a BT-20 tube. It took Bernard quite some time to pack the fragile glider inside the rocket. In fact, at one point he broke a wing leading edge and had to quickly glue it during the contest. The boost, on  $\frac{1}{4}$  power, took the model to about 70 feet, where the rocket body opened, and the glider deployed. It went into a stable glide immediately, and flew several hundred feet downwind for a duration of 48 seconds! Quite an impressive performance for a  $\frac{1}{4}$  boost/glider.

We look forward to hearing from rocketeers who are experimenting with this and other new contest events, so that we can spread the word on the results.

A recent press release from the National Aeronautics and Space Administration suggest that many of our High School age readers may soon be relying on NASA developed systems to prevent disorders in the school and take daily attendance. Under the headline "NASA Tackles High School Problems" the release details the project:

"An alarm system that shows a potential for keeping small school disorders from becoming big ones and a computer that keeps attendance records have been developed by the National Aeronautics and Space Administration's Jet Propulsion Laboratory, Pasadena, California. Both are a part of NASA's Office of Advanced Research and Technology's effort to use aerospace techniques as practical solutions to public problems. The mobile alarm has been tested at the John F. Kennedy High School, Sacramento, CA, since the beginning of the school year. Officials say it has been a significant factor in the prevention of major disorders.

"Each teacher can alert the principal's office by activating an ultrasonic device the size of a fountain pen. The device uses no batteries and can be operated from any place in the building. The system can record any number of assistance requests simultaneously. The alarm system has also provided quick

response to accidents such as helping a student welder whose glove caught fire, another whose hand was cut by a bandsaw, and another who had an epileptic attack.

"A second project undertaken by the NASA JPL team could make classroom roll call as obsolete as inkwells in the schoolrooms of America. A small computer similar to equipment used to monitor radio signals from outer space has been adapted by JPL engineers to relieve teachers of the tedium of taking attendance. The 'Automated Attendance Accounting (AAA) System' is being tested at the same Sacramento high school. If proven feasible this semester at Kennedy High, the AAA system could usher in a new push-button era for teachers. Instead of making time-consuming roll calls and written reports, each teacher pushes buttons on a small keyboard that electronically records absentees in the school's accounting office. The computer stores the information each period and does an end-of-day compilation of the school's attendance. Frank Schimandle,

Kennedy principal, says some teachers and office workers will be relieved of 10 to 14 reports daily. The AAA system is expected to save each teacher up to 40 minutes per day. The experimental system can handle up to 128 classrooms and 3,000 students. Each of Kennedy's 76 classrooms has been equipped with an AAA transmitter. Kennedy has 1,700 students and is steadily growing.

"Here's how the system works. A compact transmitter in each classroom has keys numbered from zero to nine plus buttons to signal tardy students, transmission errors, or emergency calls. Each student has a four-digit number; each teacher has a code book listing students and their numbers. The teacher presses the numbers of absent students only, which are recorded in a central computer. The computer provides readouts of class attendance each period. One clerk-typist can operate the complex after several days of training. Each teacher and room has an identifying code number, too. Principal Schimandle believes that the system will

also enable a closer check to be kept on truants and mid-day dropouts. The AAA system was adapted from a basic small computer used in Mariner missions. JPL engineers supplied the complex logic software to record the desired school data."

Results from the April/May 1971 "Reader Survey" indicate that MRM's coverage of the HIAA Trade Show was the most popular article in the issue. The feature on "Metallizing Your Scale Birds" ran a close second, with the construction article on the Space Dart B/G coming in third. The oddball "ZNT" was fourth, while our new *Club Corner* feature was rated fifth. These responses allow us to select those articles for future issues which closely reflect what you, by your letters and postcards, tell us you want to read.



# NEWS NOTES

## KEY APPOINTED ESTES VP

Hugh D. Key, 31, has been appointed Vice President and General Manager for Estes Industries, Penrose, Colorado. A subsidiary of Damon Corporation, Estes is the world's largest manufacturer of model rockets and supplies.



Hugh Key, new Vice President and General Manager of Estes Industries.

Immediately prior to joining Estes Industries, Key was Operations manager for the Lyman Gun Sight Division of the Leisure Group, Inc., in Middlefield, Connecticut. He had previously served as Manager of Operations Control at the company's headquarters in Los Angeles. During his professional career he was also associated with Mead Corporation in Dayton, Ohio.

In making the announcement, President Vernon Estes stated, "Key's joining the company will enable us to continue the steady growth Estes has enjoyed in the past. Mr. Key will assume total responsibility for the company's operations, including the marketing and production functions. This will enable the company to increase its efforts in the development of new products and product lines related to the youth hobby and educational market."

A native of Winston-Salem, North Carolina, Key holds a BS degree in textile engineering from North Carolina State University and a Master of Business Administration, from the University of Virginia. His professional memberships include the American Marketing Association and the Institute of Management Science.

## SOUTHWEST HOBBY SHOW SCHEDULED

The third annual Southwest Model Hobby Fair will be held in Oklahoma City, Oklahoma, October 30 & 31, 1971, sponsored by the Oklahoma Science and Arts Foundation. The past two fairs have proved to be very successful for the Southwest, drawing crowds from the entire area and surrounding states, plus modelers and manufacturers from all over the nation.

The 1971 Fair will again be in the "Women's Building," located on the spacious and easily accessible State Fair Grounds. There are acres of open ground for flying demonstrations and other outdoor activities, and plenty of parking. Exhibition areas within the building are ample for those modelers' and manufacturers' indoor displays. The official list this year includes: planes, boats, cars, model rockets, model railroads, and speciality models, or in other words, again, "if it sits, stands, rolls, flies or floats, it's eligible." There will be many prizes in various categories, plus films, lectures and demonstrations. Concessions will also be available.

Both those manufacturers who have attended previous fairs, and many new ones have expressed interest in being present in 1971. A special committee of the Oklahoma Science and Arts Foundation Board of Trustees has been formed to concentrate on increased ticket sales to the general public, as family attendance at the Fair is encouraged. The Hobby Fair will be open Saturday night for the first time with hours from 12 noon to 9:00 PM. Sunday hours remain from 10:00 AM to 4:00 PM. Admission is \$1.00 for adults and 50¢ for children under 12. Exhibiting modelers will be admitted both days for \$1.00. Further information is available by writing Hobby Fair Director Dale Johnson, Oklahoma Science & Arts Foundation, 3000 Pershing Blvd., Fair Park, Oklahoma City, Okla. 73107.

# APOLLO EARTH ORBITAL WORKSHOP

## A SEMISCALE MODEL OF NASA'S SKYLAB SPACE STATION

Designed by Ronnie Cramer

The Apollo Earth Orbiting Workshop is a semi-scale version of the Apollo Skylab workshop which will fly in 1973. The idea was to build a rocket which would look attractive, and yet be different from all the other birds on the rack. The upcoming Skylab space station offered an idea for the design. Build a large diameter rocket, mount an Apollo capsule on the top, use the solar panels as fins, and you will have a unique model.

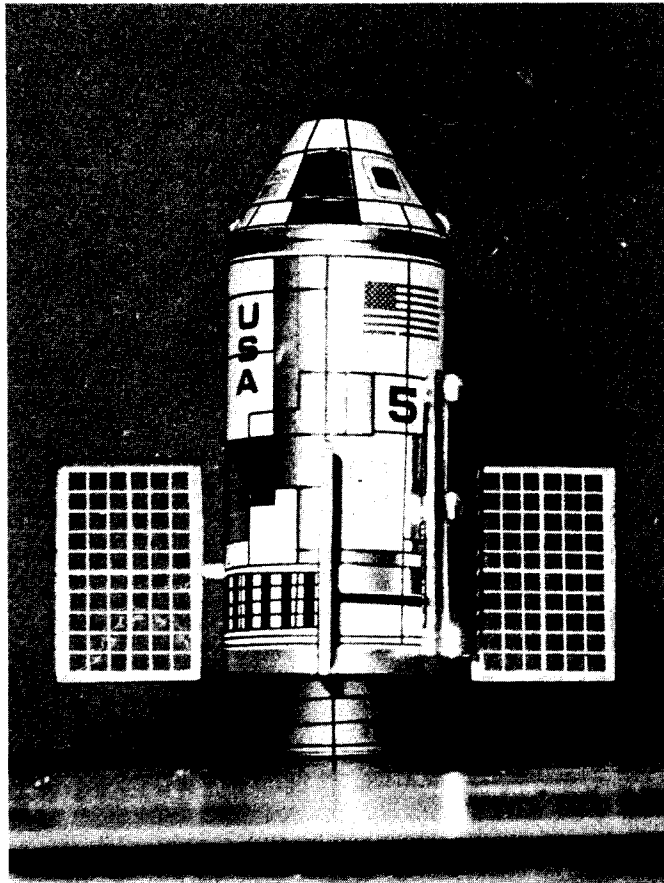

The Apollo Earth Orbital Workshop is a semi-scale Skylab. The model can be assembled from an Estes Little Joe II kit and a few spare parts.

After a few rough sketches the basic Workshop design was selected. A BT-70 body tube would form the framework, while the structure would be topped by an Apollo shuttle capsule. Four solar panels, mounted on standoffs, would serve as stabilizing fins. It soon became evident that the entire Earth Orbital Workshop could be assembled from an Estes Little Joe II kit and a few spare parts.

### Construction of the Workshop

The engine mount is the first part to be assembled. First glue an EB-20A engine block in the front end of a 2.75" length of BT-20 tube. Cut four rectangular supports 1.4" by 2.5" from a sheet of 3/32" thick sheet balsa. These supports will strengthen the engine mount assembly, and provide a mounting runner for the fin standoffs.

One RA-2070 ring is glued 1/8" from the end of the BT-20 tube. The four 3/32" thick rectangular supports are then glued 90° apart to the BT-20 engine tube and RA-2070 ring. A second RA-2070 ring is glued to the opposite end of the BT-20 flush with the balsa supports. (See assembly detail drawing.) Mark the location of each balsa support on the bottom surface of the RA-2070 ring opposite the end of the BT-20 which contains the engine block. Set this entire unit aside to dry.

The Apollo capsule (Estes kit NCK-29) is assembled according to the kit instructions. Since no escape tower is used on the Workshop, these steps in the assembly should be eliminated.

Cut a 5" length of BT-70 tube from the section supplied with the LJ II kit. Glue the engine mount assembly into one end of the BT-70, locating it such that the RA-2070 is flush with the rear of the BT-70. This allows the BT-20 to project 1/8" from the rear of the BT-70. (The lines marked on the RA-2070 to indicate the location of the internal balsa supports should be visible at the rear of the rocket. If not, *quickly* remove the engine mount, and mark the location of these supports.)

Cut four "solar panels" 1 1/2" by 2 1/2" from a sheet of 3/16" thick balsa. Carefully drill a 1/8" diameter hole centered on one 3/16" by 2 1/2" face of each balsa panel. These holes should be approximately 1/4" deep. Glue a 1" length of 1/8" diameter hardwood dowel into each of these holes in the panels.

Carefully drill a 1/8" diameter hole 1/4" from the rear of the BT-70 tube into the center of each of the balsa supports in the engine mount. (That's why the location of each support was marked on the bottom of the RA-2070 ring.) These holes should be approximately 1/2" deep.

Cut the nozzle shroud from a sheet of index card stock using the template provided in the plans. Bend the shroud into a conical shape, and glue it together. Slip the forward end of the nozzle

# APOLLO EARTH ORBITAL WORKSHOP

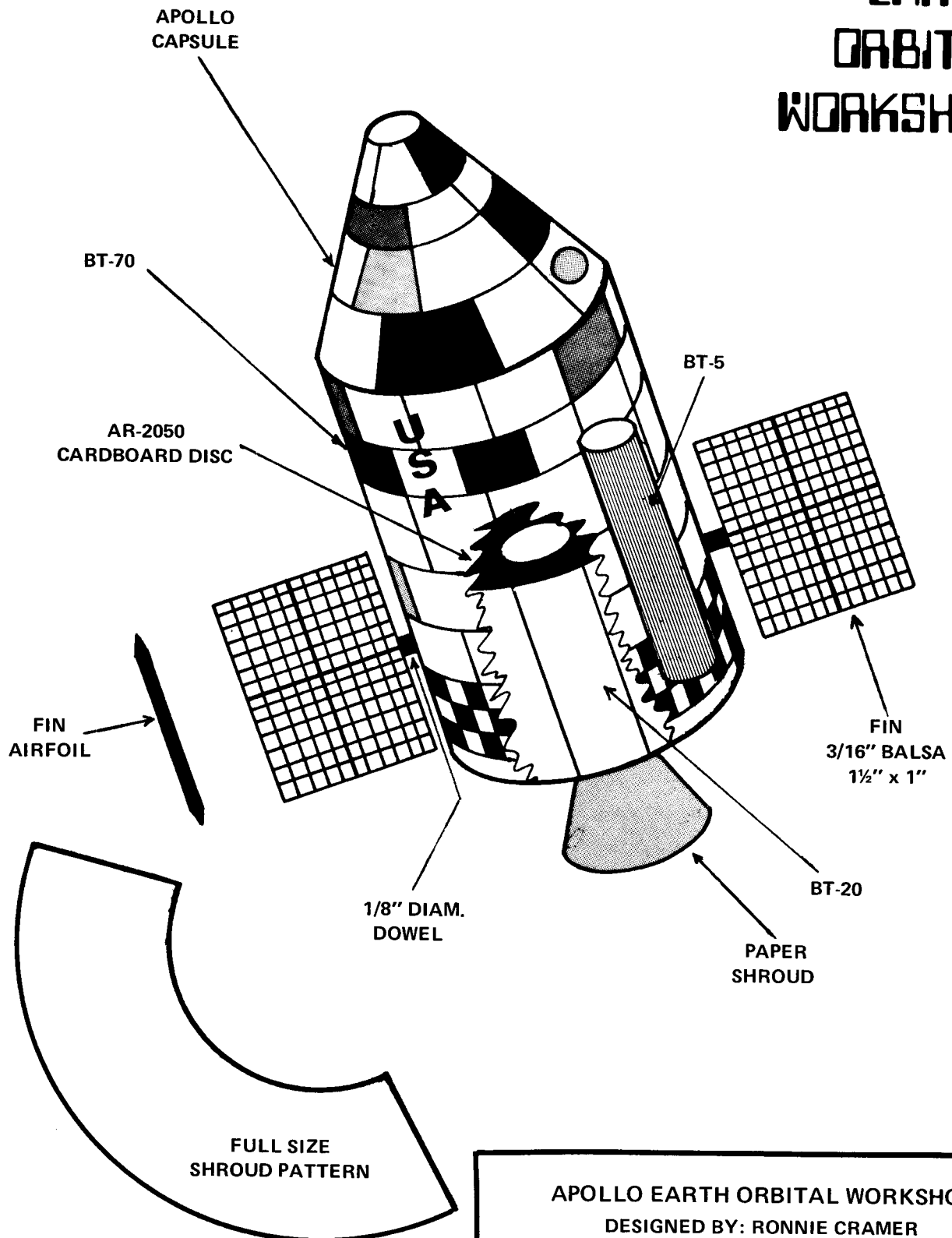

APOLLO EARTH ORBITAL WORKSHOP  
DESIGNED BY: RONNIE CRAMER  
DRAWN BY: GEORGE FLYNN 7/12/71

shroud over the projecting end of the BT-20 engine tube, and glue this shroud in place.

Cutting a 3" length of BT-5 tube to serve as the "telescope" completes the initial assembly of the Workshop. Several finishing steps should now be undertaken before the final assembly.

### Finishing the Workshop

It is easier to do the basic finishing before attachment of the solar panels and telescope. The entire BT-70 body and Apollo capsule should be painted with several coats of flat white paint. You'll find that flat white looks much more realistic on space models than the highly reflecting gloss white.

The nozzle section should be painted a blue-grey steel color. Again a flat paint should be used. The solar panels should be painted flat dark blue and allowed to dry thoroughly.

Thin white trim tape, available in large hobby shops or art supply stores, is then used to decorate the solar panels. The panels should be outlined with 1/32" wide white tape, and the crosshatching should be done with 1/64" wide tape. A six by ten block pattern will give an attractive looking solar panel. The 1/8" dowel supports should be painted flat white.

Using a soft black pencil, a grid of circular bands and longitudinal lines should be marked on the BT-70 tube. These lines will be used as a guide in locating the various colored areas on the Workshop. The pattern shown in the photographs can be copied. Some panels should be covered with Centuri DC-33 chrome plated mylar. This material already has an adhesive on the back. Centuri DC-34 gold plated mylar can also be used on some panels. Other panels should be painted flat black. Flag decals, "USA" lettering, etc. can be applied from decal sheets. The strips of 1/32" wide black trim tape should be used to outline the panel segments.

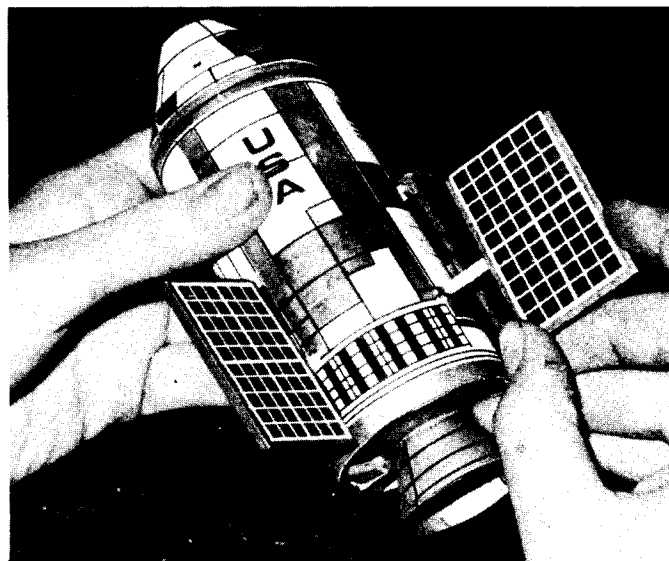

Four 1/8" diameter holes are drilled through the BT-70 tube and into the balsa supports. The 1/8" fin support dowels are then coated with glue and fastened into the body.

A similar finishing procedure should be used on the Apollo capsule. Basically the color scheme is flat white, with black (tape) panel edges, some silver and gold panels, and a flag decal on each side.

The telescope tube should be painted flat black both inside and outside. Decorative chrome mylar stripes can be added. Following finishing, the telescope should be glued to the Workshop just forward of the rear of the BT-70 and about one-third of the way from one solar panel mounting hole to the next.

When the paint is dry, add glue to the end and sides of the 1/8" dowel supports for each fin. Slide these dowels into the previously drilled mounting holes, and twist the fins until they are parallel to the BT-70 body. Set aside to dry.

### Flying the Workshop

An 18" shock cord should be attached between the main body section and the Apollo capsule. To insure minimal recovery damage, use at least an 18" chute on the Apollo Workshop.

The large solar panels insure good stability, so the Apollo Earth Orbital Workshop can be flown with engines from A to C. Two second delays should be used on the A's, four seconds on the B's, or five seconds on the C's.

With a little care in assembly and finishing, the Apollo Earth Orbital Workshop will be an impressive looking model for both display and flying.

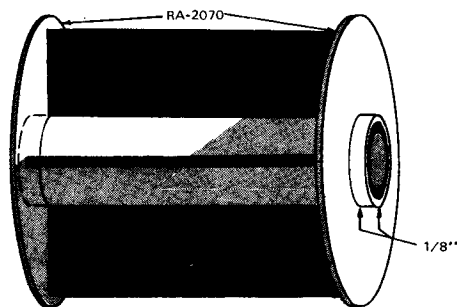

Balsa supports are glued between the RA-2070 rings to provide additional strength. In addition they serve as anchors in which to mount the 1/8" dowels which attach the fins to the model.

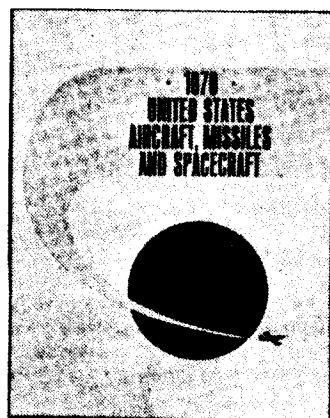

224 pp.

8 1/2" x 11"

\$3.00

## 1970 U.S. AIRCRAFT, MISSILES AND SPACECRAFT

- Authoritative information (including specifications and performance ratings) about U.S. aircraft currently in production—transports, light aircraft, helicopters, fighters, bombers, etc.
- Also, missiles, rockets, booster vehicles, earth satellites, lunar and space probes, plus 1969's outstanding aerospace events, awards, and world records.
- Illustrated with more than 450 official photographs.

Back issues for 1957 and for 1964 through 1969 also are available. Write for prices.

Please send \_\_\_\_\_ copies of 1970 U.S. AIRCRAFT, MISSILES AND SPACECRAFT @ \$3.00 \$ \_\_\_\_\_ enclosed.

NAME \_\_\_\_\_ STREET \_\_\_\_\_  
(Please print)

CITY \_\_\_\_\_ STATE \_\_\_\_\_ ZIP \_\_\_\_\_

MAKE CHECK PAYABLE TO

**NATIONAL AEROSPACE EDUCATION COUNCIL**

Suite 310, 806 15th St. NW

Washington, D. C. 20005

# New Product Notes

Estes Industries will soon introduce a new line of "mini-engines" and accompanying rockets called the "Mini-Brutes." Announcement of the new engines was made at the Hobby Industry Trade Show in Philadelphia late in June. The new engines, to be available in 1/4A, 1/2A, and A sizes, will be approximately one-half inch in diameter and 1.75" long. The new A3-2T (Estes designation for the mini-engines) will weigh only 7.2 grams compared with 16.7 grams for the A5-2 in the 18 mm x 70 mm size.

Initially the engines will be available in the following classifications: 1/4A3-2T, 1/4A3-4T, 1/2A3-2T, 1/2A3-4T, 1/2A3-0T (booster), A3-6T, A3-4T, A3-2T, A3-0T (booster). They will be packed four to a box including five igniters and 8 sheets of recovery wadding. Price will be from \$.99 to \$1.19 per package, depending on engine size.

The Mini-Brute rocket line will include three kits ranging in price from \$.49 to \$1.29. The smallest, the Mosquito, is only 3.9" long and weighs only 0.1 ounces. Its \$.49 price makes the Mosquito the most inexpensive rocket on the market. The Screamer is a streamer recovery model standing 7.8" tall. Priced at \$.99, this kit comes complete with trim decals and recovery streamer. The Mini-Bertha, a small size version of the Big Bertha, uses a BT-20 tube and stands 11.25 inches tall. Liftoff weight is 0.484 ounces, and the model uses an 8" chute for recovery. The Estes "Fleet Pack" will include one of each kit in the Mini-Brute line and will retail for \$2.49. A mini-engine adapter, to allow use of the mini-engines in rockets designed for regular Series III engines, will sell for \$.35 (Catalog No. 713-EM-520).

The entire line of mini-engines and Mini-Brute rocket kits will soon be available from Estes Industries, Dept M-31, Penrose, Colorado 81240.

Centuri's newest scale model is the high-performance MX-774 kit. The model is a semi-scale replica of America's first super-

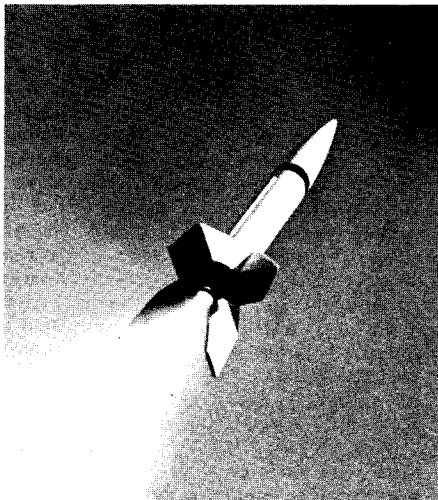

sonic research rocket after World War II. The inexpensive model offers fantastic perfor-

mance owing, in part, to its duplication of the supersonic shape of the original; it can reach velocities approaching 400 miles per hour and altitudes of almost 2,000 feet powered by B14 and C6 engines respectively.

Centuri's MX-774 model reached transonic speeds at NARAM-12 powered by an Enerjet D21-10. The D21 engine ran into production problems later—hopefully we shall see them soon. For very high performance flights or for tests at transonic speeds, the "MX" will continue to be a favorite choice.

The MX-774 kit is priced at \$1.50. Complete details on this and other Centuri models are contained in their new catalog available for \$.25 from Centuri Engineering, Dept. M-51, 3053 West Fairmont, Phoenix, AZ 85017.

MPC has introduced a catalog listing the parts, kits, and engines in their ultra-miniature Miniroc and Minijet lines. The complete catalog is available for 15 cents from MPC/Miniroc Catalog, Dept. Q, 126 Groesbeck Hwy, Mt. Clemens, Michigan 48043.

The new Minijet engines will retail for \$1.25 per package of four, with igniters, in 1/2A, A, or B sizes. The Super Star kit will sell for \$1.00 while the Pipsqueak, a kit containing two rockets, will sell for \$1.50. The Taurus-1, Astrobee D, and Asp 1 will sell for \$2.00 each, while the Delta-Katt boost/glider is priced at \$2.50. A parts kit containing four 8" T-15 tubes, four T-15 nose cones, four engine mounts, thrust rings, shock cord mounts, screw eyes, shock cord, launch lugs, and two nose weights will retail for \$3.00.

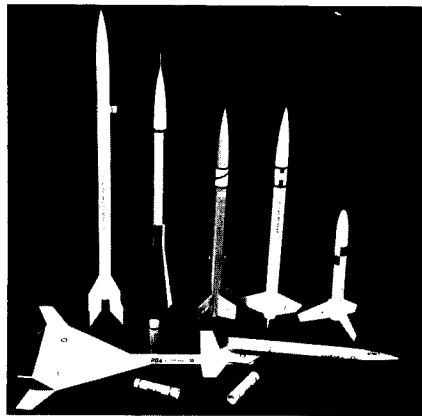

MPC's new "Miniroc" line includes (left to right): "Astrobee D," "Asp-1," "Taurus-1," "Super Star," "Pipsqueak," and in front, the "Delta-Katt" boost glider and an assortment of the new, miniature "Miniroc" engines, which pack power equal to that of the standard size model rocket engines in a smaller container.

The April/May *New Products Notes* erroneously indicated that Wayne Kellner designed the new Estes Industries "Bandit" model rocket. Actually, the "Bandit" was designed by Wayne's brother, Mark Kellner, who is a member of the Estes R&D Staff.

## WHAT'S YOUR FAVORITE ARTICLE THIS MONTH?

Vote here for your favorite articles. Let us know what type of material you want to read. List them in order — the most liked first, etc.

- 1.
- 2.
- 3.
- 4.
- 5.
- 6.
- 7.

Clip this section out or use a facsimile. Paste it on a postcard or put in an envelope and mail to:

**Reader Survey**  
**Model Rocketry Magazine**  
**Box 214**  
**Boston, Mass. 02123**

**FROM ROCKET CITY USA** — Unique offer to collectors of rare items — souvenir piece from official Lunar Lander Mockup — including colorful Apollo Flight Insignia and picture — \$3.95. Other famous and historic rocket souvenirs available soon — including Jupiter and Saturn Moon Rockets. Dew-Hawk Enterprises, Dept. A-2, P.O. Box 826, Huntsville, Alabama 35804.

## FULL SIZE PLANS AVAILABLE

In response to numerous requests from readers, Model Rocketry is making available full size plans of several Boost/Gliders published in issues of Model Rocketry which are now sold out. In future months we expect to announce the availability of scale plans from past issues, as well as reprints of the most popular articles.

### Available for Immediate Shipment

**Bumble Bee B/G** — An elliptical wing Hornet Boost/Glider which has turned in contest performances of over two minutes.  
 Full size plans—50 cents.

**Wasp B/G** — A lightweight Hornet or Sparrow B/G using a balsa boom.  
 Full size plans—50 cents.

**Dove III Flop-Wing B/G** — Complete plans and instructions for the Dove III flop-wing. Designed as a Sparrow, this model can be scaled up to higher power events.  
 Full size plans and complete instructions—\$1.00.

### ORDER FROM:

**Model Rocketry**  
**Box 214**  
**Astor Station**  
**Boston, Mass. 02123**

# NART-II

by George Flynn

The NARCAS Section of Harrisburg, Pennsylvania succeeded in their objective of selecting "unusual" events for their second annual Record Trials. Last year, NART-1 saw Condor Boost/glide flown for the first time at any major contest. This year Condor B/G, again on the schedule, was tame by comparison with some of the other events. Two of the new Rocket/Glider events — Condor and Hornet — were picked by the NARCAS Section to provide a unique engineering challenge for the contestants. Hornet B/G was also scheduled. For the non-B/G fans Class I and Class III Parachute Duration were also flown.

The major contest flying was scheduled for Saturday and Sunday, May 15th and 16th. However, just to get everyone in the mood for the upcoming events, NART-II officially opened on Friday evening with a night-launched Class II Streamer Duration contest. The event was flown under normal Streamer Duration rules, but in order for the timers to see the model throughout the flight the

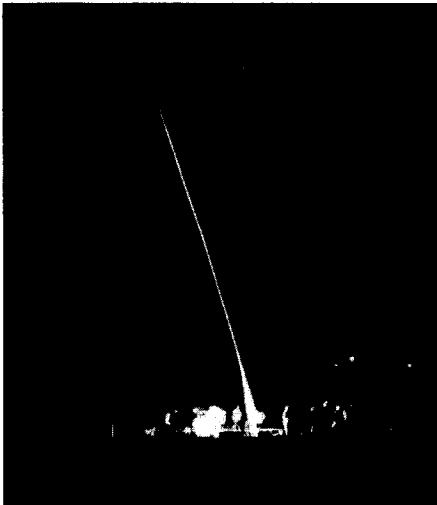

Night launched Streamer Duration got the NART-II Record Trials off to an unusual start. Beginning after it got dark, contestants prepped their models by the light of a single lantern. Each rocket was equipped with a light flasher to allow the timers to follow the birds. Even carrying the extra weight of a light flasher, the Philmon team managed a 33 second duration for first place.

rocketeer had to provide a "tracking light" of some kind on the model.

"This night will go down in model rocket history," Contest Coordinator Carl Guernsey remarked as over 20 contestants worked, one-by-one, to prep their Streamer models by the light of a single lantern. It gets pretty dark out in a deserted Army field 25 miles from the nearest town, and unless you've prepped quite a few rockets it proves a bit difficult to do in total darkness. At one point flying was interrupted when the timing crew asked "Where's the flight card?" "On the table," replied Carl Guernsey, and the timers predictably asked: "Where's the table?" It really was dark out there!

From a quarter mile away it was quite impressive to watch the rockets lift-off, ascend into the sky on a trail of exhaust, then see the engine burnout, and the flashing payload light arc across the sky and return to the ground. Most of the contestants used standard light flashing beacons in their models to aid in timing and recovery. Pam Smith of the Blackstone-Smith team placed her faith in a coating of luminescent paint on the rocket, but that faith proved unwarranted as the rocket disappeared from sight at burnout. NAR President Jim Barrowman was the only other contestant to fly without a flashing tracking device. Apparently he didn't believe the contest announcement which specified "Night Launched Streamer Duration," and chose to give it a try with his normal SD model. Much smaller and lighter than any of the other birds, it probably went a great deal higher, but the timers had to stop at the B engine's burnout, about a second into the flight.

The durations weren't bad considering the extra payload weight necessary for night flying. Typical Class II SD times are around 90 to 120 seconds with very light models. At NART, the Philmon team captured first place with a 33 second flight. David Graves managed a second place with 26 seconds, and Jim Joines took third with 24 seconds.

Late Friday night there was a contestant's briefing to familiarize the 109 rocketeers in attendance with the NART ground rules. The site, the same field used for NART-1, a military training base, contained a few hazards which Contest Director Jim Sparks pointed out to the rocketeers. The Vietnamese Village and the active firing range

to one side of the range were "off limits" and any rocket entering these areas "is disqualified and can *not* be recovered." To maintain safety on the range all Condor B/G's and R/G's had to be turned in for a safety inspection the night before the event — Friday night for the B/G's and Saturday for the R/G's.

The Condor B/G safety inspection provided an advance preview of the models to be flown. Most of the B/G's were fairly standard — a Manta parasite strapped to the side of a large F7 powered booster, a three-stage D powered rocket containing an ejectable flexwing, a double size Thunder Bird, a few flop wings, four or five Maxi-Mantas using F7's, a Manta parasite using a cluster of 5 (yes, five!) C's in the booster, a groundhog (First seen at the East Coast B/G Championships), a flying wing, and a few other designs. Then came the surprise. The safety judges examined a typical "Bertha-type" booster with no obvious parasite glider attached. One judge removed the nose cone, and a feather fell onto the judging table. "Is that the glider???" It had to be, since there wasn't anything else around. You can imagine the judges surprise when the feather, which had been trimmed by inserting a straight pin near the "nose," did a beautiful glide across the army barracks! NART has at least one surprise every year.

A classroom adjacent to the barracks used for contestant housing was made available for construction. At 2:30 in the morning the room was still occupied with rocketeers who had fallen victim to the typical contest problem — "will there be enough time to build all my models before the events close?" It was an interesting scene with some rocketeers making minor repairs, others just starting work on proven designs, and still other more ambitious rocketeers still at work designing their birds. Greg Kennedy was at work on his Condor R/G at one side of the room when another rocketeer wandered up and asked "Will that thing fly?" He answered, "I hope so!" and gave it a gentle toss across the room. It didn't quite make it into a glide, but it didn't fall as fast as Guppy's "Gargoyle" from NART-1. "I've got to do a little more work on it yet," Greg explained, and continued modifying the design.

By 8:00 AM most of the rocketeers, including a few who had been up all night





By far the most unusual of the NART-II Condors was "The Feather" — an actual feather trimmed to glide — built by Mike Angelo. It boosted inside a normal rocket, and was ejected at apex by a piston system. However, the feather "fluttered" down rather than going into a stable glide.



Jim Sparks' "Appration" is a flying wing boost-glider with a large pop-pod. The model is quite light because of the standard model airplane built-up wing construction.

working on models, were out on the field glide testing B/G's and tossing a boomerang. The early morning wind was blowing in the wrong direction — right into the Vietnamese Village and the firing range. With Class III Parachute duration the first event on the schedule, any good flights were sure to be lost. Howard Kuhn had a beautiful flight, timed a 390 seconds before it went out of sight over a ridge. But it was straight over the firing range, and DQ'ed for landing in a "restricted area." The other four minute plus flights ran into the same problem, and only the poorer flights remained on the field. The Fox team managed the only four minute plus flight to be recovered — after a duration of 289 seconds. With the wind blowing in any direction other than the way it was blowing, it would have been a good day for PD records with the clear blue sky allowing excellent contrast for chutes of all types.

Saturday afternoon brought one of the events for which everyone had been waiting — Hornet Rocket/Glider. This was the first time this event was flown at any contest, so, as one rocketeer correctly observed, "If we even get it off the ground we'll have a record." True enough, any qualified flight would be a record, but for a while it looked like there might not even be one.

The first Hornet R/G off the pad, a flop-wing by Bob Parks, followed the Condor tradition established at NART-1. It *disintegrated!* On a 1/2A engine, no less. The second attempt, a little Manta by Rich Brandon, also proved the power of those 1/2A's when it too disintegrated. Howard Kuhn, with the third rocket off the pad, ran into a little bad luck when a micro-clip hooked the tail boom of his flop-wing. Another DQ. The Fox team managed to keep their flop-wing R/G together throughout the flight, but it was DQ'ed when it impacted without deploying its wings. By this time, with the contestants batting zero for four in this new event, several rocketeers were speculating that Hornet Rocket/Glider was impossible.

Then it happened! The fifth rocket off the pad, Doug Plummer's converted Falcon, actually went into a glide. A very poor glide, but its 7 second duration gave Doug the first ever qualified Hornet Rocket/Glider flight.

The best, and in fact the only good, Hornet R/G flight was made by a Groundhog — that high aspect ratio, swing-wing design which Jon Robbins introduced at the East Coast B/G Championships. This time the Groundhogs were working, and Jon had a nice straight boost, a good deployment, and a 31 second duration. With a 36" span and a 1 1/2" chord, this glider's 54 square inch wing area was a bit higher than most of the other Hornet R/G's. Even this one would have turned in a better glide with a bit more wing area, so those 30 square inch models just didn't have a chance.

All in all, there were a total of eight qualified Hornet R/G flights — if you want to call the Fox team's four second flight qualified. But if you knock out all the sub ten second durations, the number of successes drops to three.

Next on the schedule was the Condor Boost/Glide event, a repeat from NART-1. Last year there were only three qualified flights out of over 20 attempts. This year, in more cooperative weather (at least it wasn't raining), after everyone had had a little practice the results were expected to be more impressive. The first Condor off the pad was a large booster which deployed a swing-wing at apex. The glide was good, with a duration of 102 seconds, but the recovery system separated from the booster resulting in a DQ.

Second off the pad was Richard Brandon's parasite Manta strapped to an F7 powered carrier vehicle. It boosted about ten feet, then pinwheeled end over end unstably in the air. About four seconds into the flight it stabilized and imbedded itself into the ground, where the engine continued thrusting for another 5 seconds. Adding this failure to Brandon's three successive failures with the same design at the East Coast B/G Championships, he should have been about ready to give up...or perhaps to try modifying the design. He certainly did prove its consistency!

A three-stage D powered model carrying an ejectable flexwing followed. On this one the booster worked perfectly. A good straight boost...ejection at apex...and a nice recovery of the booster. Unfortunately the flexwing was not properly glide trimmed, so it fluttered to the ground rather than gliding.

Jim Barrowman had a rather unusual Con-

dor — a rogallo wing attached to the upper section of a standard booster. Powered by an F7-6, the rogallo wing popped open on the way up, causing some damage to the "glider." Another DQ.

Bob Parks flew the first standard configuration (non-parasite) Condor of the day — a flop wing using an F7. The boost was straight for about 6 seconds, but then the bird started oscillating, and it broke apart during the last second of burn. By this time Condor was off to the same good start as at NART-1.

Next up was the Kennedy-Gibbs "Super Thunder Bird." This double sized Thunder Bird (MRM, May 1970) survived the boost but spiraled in without gliding, for a DQ. As Greg Kennedy gathered together the five largest pieces scattered on the ground he remarked, "Wait until NART-III!"

Carl Guernsey once again terrorized the crowd with his "Total Disaster." This top and bottom pod flop wing was similar to his "Total Disaster" flown in Eagle at Tri-Sec last fall. That one failed when the



The best of the Hornet Rocket/Gliders was Jon Robbins' "Groundhog-32." This model was the 32nd swing-wing Robbins has built to develop the design. Using a 36" span and a 1 1/2" chord wing, the Groundhog turned in a 31 second duration.



Carl Guernsey readies his "top and bottom" flop-wing for Condor B/G. The model used two E5-6's "because no E5-0's were available." Both ignited, and the boost was clean, but the model spiraled in for a DQ.

engine which deploys the wings did not ignite. This time Carl was using two E5-6's for power "because no E5-0's were available." The glider had a nice boost, but it spiraled in for a DQ.

Then came the "feather," the B/G which had confounded the judges the previous night. It was a real feather, trimmed to glide, and with Mike Angelo's NAR number painted on the bottom. The boost, inside a F100-8 powered carrier rocket, was good. At ejection the small feather and much wadding came out. However the feather never started gliding, it just fluttered down, beating the booster to the ground. In case you haven't been counting, that was the 7th successive DQ in the Condor event. Who ever said NART-1 couldn't possibly happen again?

Next up was the Fox team, including among its members Dave Crafton who placed first in Condor at all three East Coast meets at which it has been flown. He seemed well on the way to doing it again, when the Fox team's D13-0, E5-6 two-stage parasite Manta turned in a 99 second duration with a good boost, clean separation, and nicely trimmed glide. The first Condor success at NART! The state-of-the-art is obviously improving; at NART-1 it took until Sunday morning to get off a qualified Condor B/G flight.

Randy Black's large flop-wing (shown on last month's cover) used a D18-0 and two D6-0's for power. He got all three ignited, and the boost was straight, but one of the hinges ripped off and the wings only partially deployed. Another DQ.

After destroying his earlier glider, Bob Parks readied his radio-controlled flop-wing. The radio unit was a modified Albin receiver and Bentert actuator, providing an onboard RC weight of only an ounce. The glider was a standard flop-wing powered by an F7 and D18 cluster. Ignition was perfect, and the boost and deployment were excellent, but the glider got caught in a 15 to 20 mph



Howard Kuhn's seemingly indestructible Maxi-Manta was one of the few non-parasites to turn in a good time. With an 86 second duration, the Manta finished well behind its "little brothers," the parasite Mantas which managed two minutes.

wind. Bob didn't have sufficient control to keep the glider going over the field, and it slowly drifted into the woods across the road. The duration was 75 seconds, and the glider with its expensive radio gear was recovered from the woods by an Army group.

By this time Rich Brandon had his previously disastrous Manta parasite ready to fly again. After having this model go unstable four successive times, he decided to add a bit of nose weight — one small rock and a spent engine casing. This time the boost was quite stable, and the model *disintegrated* towards the end of the F7's burn. Another DQ.

Jim Sparks flew an unusual "flying-wing" boost/glider, powered by an E5-0, an E5-6, and a 1/2A. A built-up wing covered with monokote was used to cut down on the weight, but even so the roughly four foot span glider was quite heavy. The boost was good, but it didn't get up high enough to turn in a good duration.

Tom Wuellette had the biggest cluster of the day — a cluster of *five* C engines in the carrier for his Manta parasite. Ignition, surprisingly, was perfect. A good boost and deployment put Tom's model up high enough for the best flight of the day...a duration of 157 seconds.

The Joines family had some bad luck with a series of three Maxi-Mantas. These models, powered by single F7 engines, all fell victim to the same problem. The F7 just didn't have enough sustaining thrust to give the heavy Maxi-Mantas a good straight boost. One power pranged, while the other two were on their way down by the time the ejection charges went off.

Then another Manta parasite got into the act. Tim Bray used an F7 engine on his carrier vehicle, and met with the same fantastic success everyone else at the meet, with the exception of Rich Brandon experienced. Tim's model had a perfect boost,

and a beautiful glide. With a duration of 151 seconds, he barely missed edging out Tom Wuellette for first place.

As the Condor flying was coming to a conclusion, Jon Robbins brought out his big swing-wing Groundhog. This 6 foot span, 2" chord, model is the same one flown three weeks before at the East Coast B/G Championships. Again the model was powered by two E engines, but one wing didn't deploy fully, and the model spiralled to the ground.

The closing Condor flight was an attempt by Howard Kuhn to redeem himself from the Maxi Manta catastrophe at NART-1. Last year he made three attempts to get the Manta to fly without a single success. This year's model was a cut-out and silk-covered version, again powered by an F7 engine. The boost was good, but deployment occurred a few seconds after arc over. The glide was excellent, and Howard managed an 86 second duration.

All in all, Condor was a victory for the parasites. Tom Wuellette's first place model, Tim Bray's second place model, and the Fox team's fourth place model were all parasite Mantas boosted by a cluster of five C's, a single F7, and a two stage D13-0, E5-6 respectively. The exception, Bob Parks' third place model was a large RC "flop-wing." Once again, as at the East Coast B/G Championships, the parasites dominated field. The trick seems to be to select a parasite large enough to be seen from the ground at deployment, but small enough not to significantly effect the boost trajectory of the carrier vehicle. These small models are consistently out boosting the standard configuration gliders, and exhibiting a higher degree of deployment reliability than most of the more complex variable geometry designs.

On Saturday night, following a picnic at a nearby lake, home movies of NART-1, ECRM-5, and several other meets were shown in the barracks which served as a construction



The "Super Thunder Bird," a double size Thunder Bird B/G, was built strongly enough that disintegration was no problem. But the glide trim was a little off, and the Kennedy-Gibbs team B/G spiraled in to a destructive impact.



The only "standard configuration" B/G among the four top Condors was Bob Parks' radio-controlled flop-wing. Using single channel rudder only, Bob managed a duration of 119 seconds.

room. In between the movies, many contestants sat at the work tables building their models for Sunday's Hornet B/G event.

In typical NART tradition, the contestants awoke on Sunday morning to the sound of rain bouncing off the barracks windows. This year the rain was (fortunately) a little lighter than last year, but it had been going since 2 AM and even the grass in the barracks area was getting muddy. At an 8:00 AM meeting, with the rain continuing, CD Jim Sparks announced: "Just in case anybody is wondering, we are going to fly today."

There was a friendly atmosphere out on the range as rocketeers compared notes with each other on which glues are water soluble. Just for the record, Elmers white glue is, as one contestant discovered when the fins fell off his PD bird.

The first rocket off the pad was announced as a "Class 5 Streamer Duration" model. This F100 powered bird, carrying a 15 foot streamer, went out of sight going up! With Hornet B/G on the schedule, there was going to be little possibility of putting these 1/8A birds through the 500 foot ceiling. Condor rocket/glider, however, might be more of a problem.

Doug Plummer quickly prepped the first Hornet B/G, while trying to shield it from the continuing rain. He shouted, "Launch it quick, before it gets wet." as he left the pad. However, Carl Guernsey at Range Control asked him: "Do you want to wait for timers?" Within minutes the timers were ready, and Doug's B/G "Red Barroned" in full view of the timing team.

The rain and dampness caused some strange warping of the unpainted balsa wings, resulting in some unusual Hornet flights. At times in the rain it was hard to trim a glider, and have it remain in trim while it sat on the pad collecting raindrops. The good Hornet glides were few and far between, but there were two flights with durations of over 1 minute each.

Tam Joines had the best Hornet flight



The Fox Team's parasite, which took fifth place overall, was a full size Manta on an Estes Omega booster. Powered by a D13-0 and E5-6, the glider managed a 99 second duration.

with a standard Wasp B/G. It caught what must have been the only thermal on the field, and went drifting downwind. At least the wind was cooperating, with a shift on Sunday morning so that the models were being blown down the long direction of the field. By the time his model touched down, it was timed at 100 seconds. Certainly not a bad Hornet time even under the best of circumstances, and quite spectacular considering the weather.

Tom Wuellette flew an unusual glider in the Hornet event. It looked like a set of Bumble Bee wings with a fin attached to the lower side, and a small boom extending two inches in front of the wing. There was no stabilizer on the model. The boost seemed quite a bit higher than most of the other models, but the glide was somewhat erratic. When gliding, the glide was beautiful; but each time it was hit by a gust of wind the



The Hornet B/G's ranged from Bob Parks' low aspect ratio, circular winged model which turned in a 54 second duration .....

glider would flutter down thirty or forty feet before recovering into a glide again. However it was a consistent performer, turning in 53 seconds on its first flight and 68 seconds on the second try.

Jim Sparks had another unusual glider, a much smaller version of the "flying-wing" which he flew in the Condor event. It looked good, but he couldn't keep the pod on during boost. Both time the pod stripped, and the glider turned in only a few seconds in a glide from ten or fifteen feet.

The most inexpensive Hornet was a creation by Bob Parks. Using small pieces of styrofoam from a General Tire advertising promotional glider, Bob constructed a circular-winged glider which he trimmed by bending up the trailing edge of the wing until it glided. As unlikely as it may seem, Bob managed a 25 second duration with this model.

The rest of the NART Hornets were fairly standard. Mostly Bumble Bees, Wasps, and Falcon kits were being flown, but there was no way to compare the performances since the wind and rain conditions varied rapidly throughout the day.

The final event on the NART schedule was Condor Rocket/Glider. With the bad weather some contestants declined to fly their models, and others didn't complete construction in time to present them for safety check. As a result, the Condor R/G field was narrowed to only four entries.

First up was Douglas Barth whose model used a Sig styrofoam wing section. Power was supposed to be provided by a cluster of three D engines, but the flight was recorded as a "misfire" when two of the D's failed to ignite.

The Fox team's entry was a balsa flop-wing standing about three feet tall. This one was powered by 2 D-13's and a 1/8A6-2S to put it in the Condor category. The boost was straight and there didn't seem to be any severe oscillations, but the flop-wing shredded on the way up for a DQ.

Then came Jon Robbins Groundhog, this one modified to retain its two E engines in place during glide. By now Jon's swing-wing B/G's were becoming quite familiar to all the contestants. The boost was beautiful,



..... to Rich Brandon's ultra high aspect ratio, standard wing glider which shredded during boost.



The Fox Team flop-wing was one of the Condor R/G's which failed to perform as planned. This one ripped its wing off on the way up.

straight up, and for once Jon got a good apex opening on the swing wings. They deployed perfectly, and the model made a beautiful glide. Jon had to do a bit of running to pick up the model as it drifted with the wind. The duration was an impressive 170 seconds, which exceeded the current FAI Condor Boost/Glide record.



Liftoff (left) of Jon Robbins' contest-winning Groundhog 33. After recovery, Jon displayed the first Condor Rocket/Glider ever to fly successfully for the crowd of spectators.



The final Condor R/G flight of the day was another flop-wing by Howard Kuhn. This one, powered by an F74, ran into some difficulties during boost. About 5 seconds into the flight it looked like one wing partially opened resulting in some damage to the wings. Overall, the duration was 17.5 seconds to impact, and a DO.

Once again by choosing some difficult and previously unflown events, Harrisburg's NAR-

CAS section provided a unique challenge to Northeast area rocketeers. The weather didn't cooperate, but this proved no serious obstacle to those rocketeers who wanted to see and participate in the development and optimization of new designs. By next year, perhaps, NART-II's failures will have been further developed into workable designs, and the successes will have been perfected into reliable, contest-winning designs.

## NART-2 RESULTS

### Class III Parachute Duration

Div. A/B	1st	John Penn (AAR)	175 sec.
	2nd	John Omachel (NARHAMS)	142 sec.
	3rd	Fred Brundick (HASM)	97 sec.
Div. C	1st	Richard Brandon (Three Rivers)	221 sec.
	2nd	Leslie Leonard (SSB)	187 sec.
	3rd	Tim Bray (Three Rivers)	186 sec.
Div. D	1st	Fox Team (SCS)	289 sec.
	2nd	Richard Emerson (NARCAS)	211 sec.
	3rd.	Tom Wuellette (Three Rivers)	181 sec.

### Class I Parachute Duration

Div. A/B	1st	Mike Joines (AAR)	305 sec.
	2nd	John Omachel (NARHAMS)	114 sec.
	3rd	Tam Joines (AAR)	31 sec.
Div. C	1st	Scott Snyder (AAR)	150 sec.
	2nd	James Visser (NARCAS)	81 sec.
	3rd	Roy Rosenfeld (HASM)	72 sec.
Div. D	1st	Kennedy-Gibbs Team (NARHAMS)	168 sec.
	2nd	Bob Parks (NARHAMS)	93 sec.
	3rd	Fox Team (SCS)	82 sec.

### Hornet Boost/Glide

Div. A/B	1st	Tam Joines (AAR)	100 sec.
	2nd	Andy Judkiss (SCS)	47 sec.
	3rd	Mark Hopkins (NARCAS)	5 sec.
Div. C	1st	Cherney-Pollack Team (SSB)	51 sec.
	2nd	Jamie Clay (AAR)	43 sec.
	3rd	Dan Nardonej (NARCAS)	32 sec.
Div. D	1st	Tom Wuellette (Three Rivers)	68 sec.
	2nd	Bob Parks (NARHAMS)	54 sec.
	3rd	Philmon Team (RR)	48 sec.

### Hornet Rocket/Glider

Div. A/B	1st	Tam Joines (AAR)	7 sec.
	(no other qualified flights)		
	Div. C	1st	Tim Bray (Three Rivers)
Div. C	2nd	Jay Gill (Gemini)	18 sec.
	3rd	Doug Plummer (NARCAS)	7 sec.
	Div. D	1st	Jon Robbins
2nd		Kennedy-Gibbs Team (NARHAMS)	8 sec.
3rd		Philmon Team (RR)	8 sec.
		Fox Team (SCS)	4 sec.

### Condor Boost/Glide

Div. A/B	1st	John King (AAR)	99 sec.
	2nd	Rusty Lindgren (NARCAS)	40 sec.
	(no other qualified flights)		
Div. C	1st	Tim Bray (Three Rivers)	151 sec.
	(no other qualified flights)		
	Div. D	1st	Tom Wuellette (Three Rivers)
2nd		Robert Parks (NARHAMS)	119 sec.
3rd		Fox Team (SCS)	99 sec.

### Condor Rocket/Glider

Div. D	1st	Jon Robbins	170 sec.
(no other qualified flights)			

### Night Launched Class II Streamer Duration (Not flown in age divisions)

1st	Philmon Team (RR)	33 sec.
2nd	David Graves (RR)	26 sec.
3rd	Jim Joines (AAR)	24 sec.



# F L I G H T T E S T

by Jon Randolph

*You know, I'd sure like to buy \*\*\*'s new scale kit, but I wonder if it's really scale? I'd power my new payloader with \*\*\*'s new engines, but I heard they weren't reliable. I wonder if that new book on rockets has any information on relay ignition systems? Does anyone make a tool to accurately space these rivets?*

Questions similar to the above are often overheard at hobby shops, club meetings, and contests across the country. This new column, *Flight Test*, hopes to help you answer some of those questions. How? By giving you a review (bi-monthly, initially) of new products with attention to specifications, performance, and availability. For a typical product coverage might include such topics as physical dimensions, weight, flight evaluation, reliability, where the product is available, and cost. Naturally, the information given will differ depending on the kind of product being tested.

What merchandise can you expect to see reviewed? *Flight Test* will try to examine all products of interest to the model rocketeer. Obviously, this will include new kits and engines, but—equally important—tools, materials, and publications will also be evaluated.

Simple? Well there are a few strings attached. For *Flight Test* to be successful and accurate, there are three major areas of responsibility—those of the column, those of the manufacturer, and those of the reader. The column is responsible for assuring a fair and accurate evaluation of all items reviewed. Its policy will be to review all items in a positive manner, although defects or deficiencies (if any) will be described. *Opinions expressed in this column are solely those of the author (unless indicated otherwise) and are not necessarily those of Model Rocketry magazine or any organization.* Manufacturers are invited to provide samples of new products which they feel are of interest to the rocketeer. It is the intent of *Flight Test* to review only worthwhile products, not provide free advertising; however, all items unsuitable for review will be returned along with an explanation. If any manufacturer or reader feels that a product has been incorrectly evaluated and sufficient evidence is presented to support this, the product will be re-tested. Readers are invited to express their opinions on *Flight Test* appraisals and to suggest products for review. All *Flight Test* correspondence should be directed to:

*Flight Test*  
c/o Jon H. Randolph

10301 Lake Ave. Apt. 520  
Cleveland, Ohio 44102  
Area Code 216 961-0467

Now that you know the general intentions of the column, let's take a look at our first two products—books. *Books!* How can you fly a book? You can't, but as mentioned previously, *Flight Test* is concerned with all items related to rocketry, not just kits and engines. Furthermore, these two books may help your flying rockets fly better.

The first book, *The Model Rocketry Manual* (Sentinel Books Publishers, Inc., New York, 1970) by G. Harry Stine, is primarily intended to assist new rocketeers who have been introduced to the hobby through their local hobby shop. The book is reasonably priced at \$1.50 (soft-bound), considering its 47 diagrams and photographs and 96 pages including an index. *Flight Test* strongly recommends this book to all new rocketeers as an introduction to the hobby of model rocketry. Take my word for it—this book will save you many hours of trial and error experimentation. *The Model Rocketry Manual* should be a stock item in your local hobby shop; if not, the proprietor should be able to order copies for you and your club.

The manual begins with an introduction to model rocketry, the selection of a first model, and the principles of model rocket operation. Next, basic tools, materials, adhesives, and construction techniques are discussed to get the novice off to a proper start. Finally, after covering the basics of engine design, the engine classification system, and the various launchers and control-

lers available, Mr. Stine takes the reader out to the range and explains the fundamentals of streamer and parachute packing, engine and igniter installation, and preflight safety checks. Accompanying each of the five chapters are several suggested projects for the beginner.

The manual does contain several minor errors on pages 54 and 55. Figure 30 (page 54) should read C10, C5, not B10, B5. On the next page, Figure 31 should read B5, C5, not A5, B5. These errors can be easily corrected in your personal copy.

The second book, also by Stine, is the *Handbook of Model Rocketry* (Follett Publishing Company, Chicago, 1970). This book contains over three times the pages (304), almost four times the illustrations (168), and sells for about four and a half times the price (\$6.95) of *The Model Rocketry Manual*. Examining the above arithmetic, you may suspect that this is a bad buy. Wrong! This book is a fine hard-bound edition with sturdy binding, quality paper, and sharp, clear illustrations. If you're not willing to invest an extra \$2.00 for the better binding, a paperback edition is available at \$4.95. *Flight Test* also highly recommends this book, not just because it's informative and enjoyable to read (as you should have guessed from Harry's articles in MRm), but because high volume sales may encourage other major publishers to examine our hobby as a potential market place. The handbook is available through your local book store.

The *Handbook of Model Rocketry* includes all the subjects covered in *The Model Rocketry Manual* plus such advanced topics as stability and shapes, multistaged models, rocket-powered gliders, E and F engine models, and altitude determination. Also included are the Barrowman CP calculation formulae, a bibliography, a glossary, and a list of useful model rocketry addresses.

This is the third edition of the original *Handbook of Model Rocketry* (1965). For those of you who have earlier editions, the changes include 23 new or updated illustrations, plus several text revisions. Unfortunately, the third edition still contains references to the older engine classifications (B.8-0) as well as the current engine designations (B6-0).

Next column, *Flight Test* hopes to bring you reviews of the Cox DB, MPC's Minijets, and *Above and Beyond*, *The Encyclopedia of Aviation and Space Science*. See you then!

## HEN GRENADE



**CANADIAN DISTRIBUTOR:**  
Space Age Industries of Canada  
P.O. Box 88, Youngstown, Alberta

**Only \$2.50**

**Now At Your Local Hobby Shop!**

# Model Rocket Drag Reduction by 'Boat-Tailing'

## Part II

by George Pantalos

Last month, in Part I, we considered the theoretical advantages of "boat-tailing" high performance model rockets. Basically a boat-tail is used to reduce the base drag of a model rocket. This is accomplished by tapering the model from its required payload body diameter to a smaller base diameter. This "boat-tail" acts to reduce the low pressure area (wake) behind a model and thus reduce the base drag force. Theory indicates that the base drag is reduced by a factor equal to the quantity of the base diameter divided by the body diameter, cubed, multiplied by the base drag of a model with the same body diameter but not boat-tailed. Therefore:

$$\text{Base Drag} = (D_{\text{base}}/D_{\text{body}})^3 \times \left( \frac{\text{no boat-tail}}{\text{Base Drag}} \right)$$

In order to confirm the theoretical drag reduction, a series of smoke tunnel and wind tunnel experiments was conducted. A payload section with a maximum diameter of 1.85" (typical of many egglofter models) was selected for the study. Two models (shown in figure 4) were constructed. Model A is

a normal cylindrical model rocket with a body diameter of 1.85". Model B is a similar model with the rear section boat-tailed to 1.25" in diameter and the fins moved slightly forward.

According to theory, the boat-tailed model should have  $(1.25/1.85)^3$  or 31% of the base drag of the non-boat-tailed model. In terms of the model's total drag force ( $D_T$ ), this should mean a reduction of 7% of the non-boat-tailed model's drag.

### Smoke Tunnel Testing

A preliminary method of drag analysis is smoke tunnel testing. A smoke tunnel (see *MRM* August, 1969) is a small, low speed (10-20 fps) wind tunnel into which streams of smoke are injected. Analysis is made by studying the airflow pattern around the test models. Although smoke tunnel testing does not yield any numbers for drag forces, it does provide an effective way to make a qualitative comparison of test models. The concept is basic — the more turbulence, flow detach-

ment, or wake size observed, the greater the drag force will be and vice versa.

For this report, the smoke tunnel shown in Figure 5 was used. Photographs of the airflow patterns observed in smoke tunnel testing are shown in Figure 6.

As can be observed from the smoke tunnel pictures of models A and B, the difference in the airflow patterns is in the size of the wake. Model A has a larger wake than Model B. Therefore it would be expected that Model B will have less drag than Model A.

Smoke tunnel analysis and aerodynamic theory give a feeling for the proportion of the total drag forces, however wind tunnel drag force tests are necessary to run to determine the actual numbers for the total drag force ( $D_T$ ) and the drag coefficient ( $C_D$ ) of each test model.

### Wind Tunnel Testing

The wind tunnel testing was accomplished in a sub-sonic wind tunnel at the Ohio State University. A pendulum drag balance system

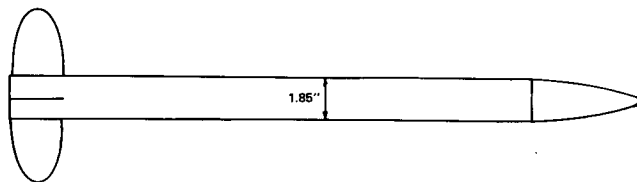

Figure 4a: Cylindrical "Model A."

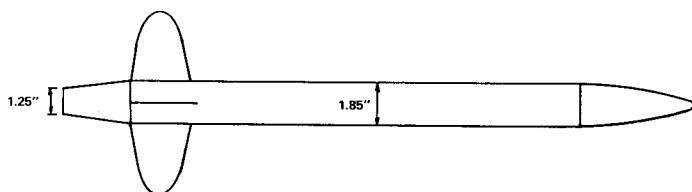

Figure 4b: Boat-Tailed "Model B."

Figure 4: Two designs were used in the smoke tunnel and wind tunnel testing. Model A is a standard cylindrical rocket of 1.85" diameter. Model B uses a "boat-tail" to reduce the 1.85" payload diameter to a 1.25" base diameter.

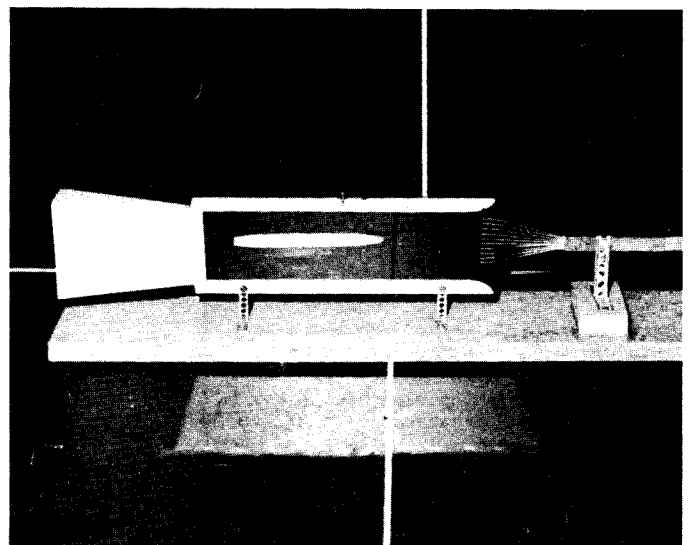

Figure 5: The Smoke Tunnel Test Facility. Each test model is sandwiched between two plastic sheets and streams of smoke are channeled through the chamber. The airflow pattern past each test model can then be observed and photographed.

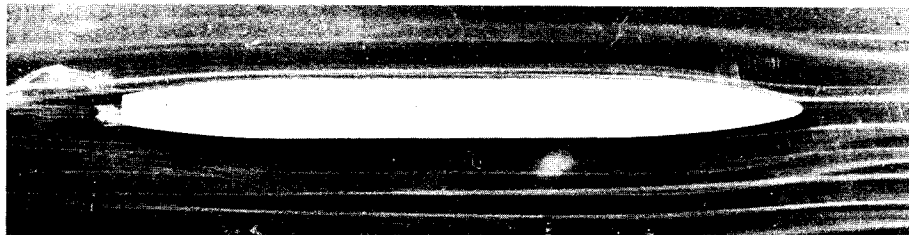
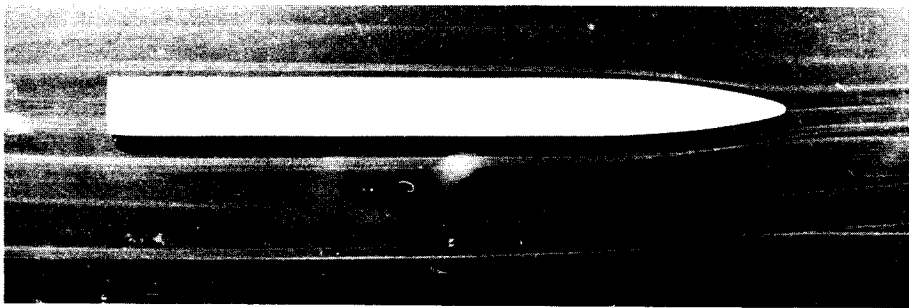

Figure 6b: Smoke Tunnel Test of Model B.

Figure 6: Photographs obtained during the smoke tunnel testing of Model A and Model B confirm that a substantially smaller area of wake turbulence is observed behind the boat-tailed model (Model B) than behind the normal cylindrical rocket (Model A).

was used. With this system, the test model is hung from the tunnel ceiling. The weight of the test model, multiplied by the tangent of the angle of deflection ( $\theta$ ), yields the total drag ( $D_T$ ) at that particular velocity. A diagram of the pendulum drag balance system is shown in Figure 7.

Measurements in the wind tunnel were taken at several velocities so that a significant graph of the data could be obtained. The graph of this data appears in Figure 9.

A quick analysis of Figure 9 reveals that Model B has substantially less drag than Model A as predicted. This amount of drag reduction can be a very important factor in model rocket research or competition.

The Total Drag ( $D_T$ ) for the boat-tailed model (Model B) was significantly below that of the standard cylindrical model (Model A) throughout the entire test range. Typically, at 130 fps the boat tailed model has a drag reduction of approximately 25% from that of the standard rocket.

It must be noted that, because of facility limitations, the models could not be tested at normal flight velocities. However, the curve characteristics established at velocities slightly lower than the flight velocities will continue through the range of flight velocities.

Another factor of the testing may be considered. The test models were slightly over two feet long. Most altitude and duration birds are generally half this length. With this in mind and using the principle of dynamic similarity\*, it can be seen that a very sim-

\* The principle of dynamic similarity states that when the Reynolds Number ( $R_e$ ) of a test condition equal the  $R_e$  of the flight condition, the aerodynamic coefficients are mutually shared between the two conditions.

$$R_e = VL\rho/\mu$$

where:

- V is the velocity of the flow
- L is the length of the test model
- $\rho$  is the mass density of the flow
- $\mu$  is the viscosity of the flow

ilar  $D_T$  vs V curve and the same  $C_D$  vs V curver would exist for these smaller birds at nearly twice the test velocities (which would be in the range of normal flight velocities).

For those of you who like to use  $C_D$  values for altitude prediction charts, Figure 10 provides a graph of  $C_D$  vs V for the wind tunnel tests.

### Applications

The boat-tail can be used with just about any model rocket in which a taper from a larger diameter body tube to a smaller diameter body can be made. In competition, altitude, parachute and streamer duration, payload, and egglofting birds are models with which the boat-tail can be used very effectively. In research, the possibilities are endless.

### Conclusions

Aerodynamic theory and smoke tunnel testing suggests that boat-tailing a model rocket aids in reducing its drag. Wind tunnel studies in which drag forces for boat-tailed and non-boat-tailed models were determined

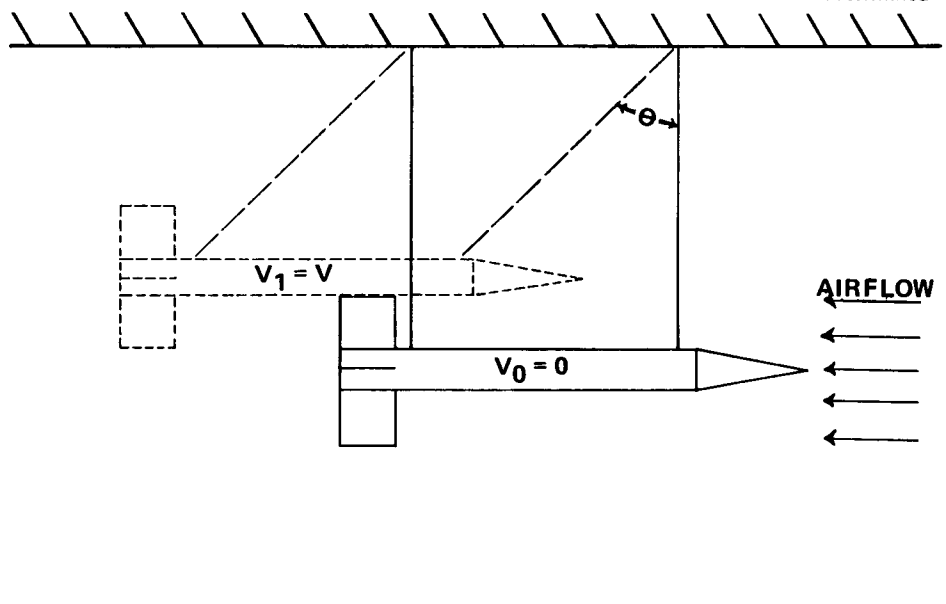

Figure 7: A "Pendulum Drag Balance System" was used to determine the Total Drag ( $D_T$ ) of test models A and B in the wind tunnel.

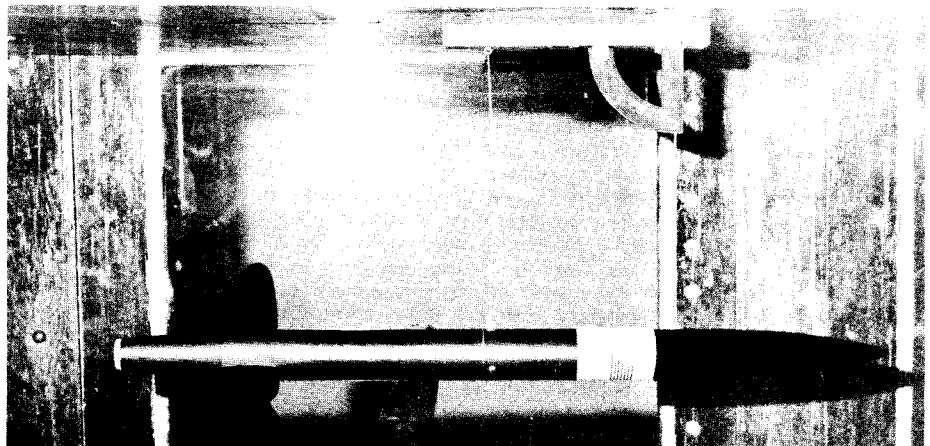

Figure 8: Test Model B shown on the pendulum balance setup in the wind tunnel test section.

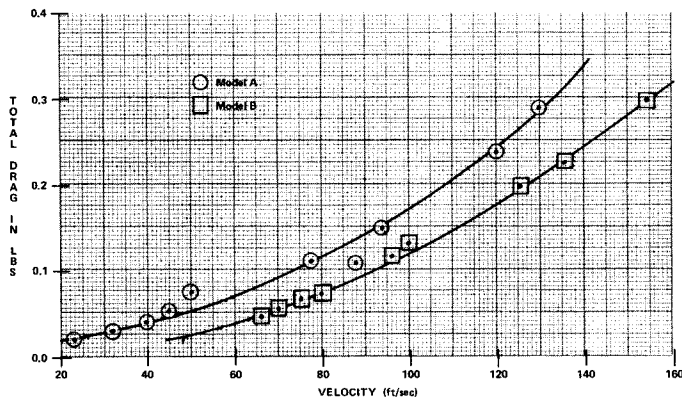

Figure 9: Graph of the wind tunnel data obtained for models A and B showing the Total Drag ( $D_T$ ) vs velocity.

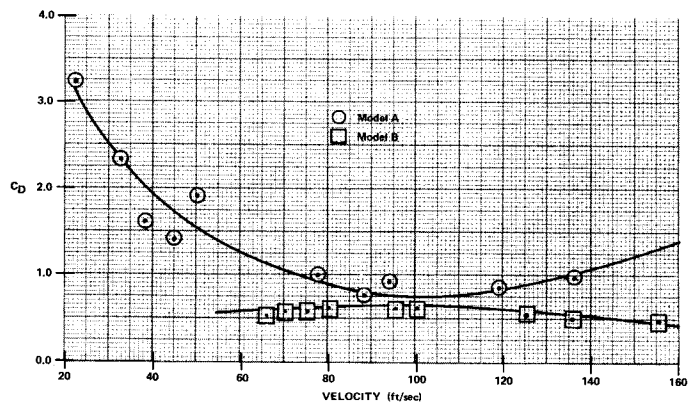

Figure 10: Graph of  $C_D$  vs  $V$  for test models A and B.

establish that boat-tailing is effective in reducing drag. With the use of a boat-tail almost any rocket with body tubes of dif-

ferent diameters can be made more aerodynamically efficient than the standard cylindrical rocket.

Part one of this report was published in the July 1971 MRm.

## RC B/G Development at Estes

Work is continuing at Estes Industries on the development of a Radio-Controlled Boost/Glider. Last summer, under the direction of Project Engineer Larry Renger, the Sky Dancer RC B/G was developed and flown. The initial results were impressive enough to permit a public demonstration flight at NARAM-12, only a week after the model's first R&D flight.

The first Sky Dancer, with a wing span of 4 feet, had a structural weight of 5 ounces and was boosted using a cluster of two D engines. The RC unit was a Kraft KP-38 system with 100 mah batteries and KPS12 servos. The Sky Dancer used only aileron and elevator control, so the model carried 5½ ounces of radio gear. (No modifications were made to the standard Kraft equipment, except that the mounting lugs were cut off the servos and they were mounted using double stick foam tape.)

Flying the model with everything from a single D engine to a three-stage D pod, Larry Renger reports that durations were averaging about 2½ minutes with one good flight lasting 6 minutes. Test flights of this first large size RC B/G provided information in a number of areas:

1. Structure — A model capable of carrying in excess of 5 ounces of radio gear can be built within the weight limitations imposed by the Safety Code, and flown with a cluster of two D engines,
2. Stability — The low-wing configuration causes some stability problems, and a high-wing will be used on future models,
3. Boost-pods — The rear-ejecting pop-pod and the two-stage pop-pod were successfully developed and flown.

Following testing to the original Sky Dancer, the model was retired. Work is now underway at Estes on another large RC B/G. This one is lighter, has a semi-symmetrical airfoil (to allow long inverted flight and better rolls), and 12% more wingspan (54") than the original. The whole model has been smoothed out and cleaned up. The fuselage now has an oval cross section rather than the square fuselage on prototype 1. To improve stability, a shoulder mounted wing is used rather than the low wing configuration.

Based on his experience with the Sky Dancer, Larry Renger observes: "I am convinced that the basic direction of a large, built-up structure carrying a real payload of radio gear is the route to go. Sky Dancer is completely controllable, both under boost and glide. We can stunt maneuver and thermal soar under really effective control.

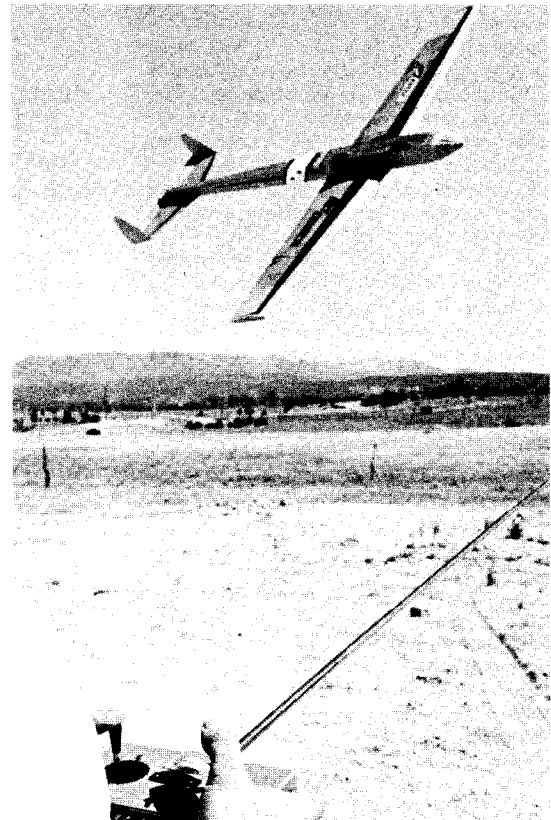

The Sky Dancer, under aileron and elevator control, has proved its capability for stunt maneuvering and thermal soaring. Structural weight of the 4 ft span glider is 5 ounces. Adding another 5½ ounces for the Kraft RC unit and about 4 ounces for the engines and pod, the Sky Dancer weighs in at just a little under a pound.



# A HIGH PERFORMANCE BUILT-UP WING CONTEST BIRD

## THE BUTTERFLY II

### Hornet B/G

by Thomas Milkie

The Butterfly II was the outcome of some investigations into strength needs vs weight of a hornet boost/glider. The resulting glider appears to be a winner. The Butterfly II design was first flown at an MIT section meet and was "thermalled away" for a record-setting 196 sec. flight.

The Butterfly started as an attempt to beat out the Bumble Bee design (MRM, December 1969) which everyone seems to be flying these days. The Bumble Bee appeared to be overstrengthened with its large spruce fuselage and balsa wing. Hornet class boost/gliders are only powered by 1/2A's and surprisingly little strength is needed in some areas. Having done some work on built-up wings (using spars, ribs, etc.) for larger boost/gliders, I decided that even small B/G's could benefit in weight by using tissue-covered wings. The Butterfly weighs only about 5 grams yet has twice the wing area of a Bumble Bee.

If the tissue is kept taut the wing will have a surprising amount of strength. Since a built-up wing can be thicker than a balsa sheet, it is also less apt to vibrate apart, and can be better aerodynamically for the same weight. Also, strength can be concentrated where it is really needed — the leading and trailing edges which often absorb the shock of landing.

The rib structure with slanted ribs, combined with the front-leaning elliptical wing, the leading edge springing forward, and the tissue covering, all help produce a fairly strong, light wing. The greatest stresses — wings going back under boost and moving forward under crash landing — are easily absorbed.

The fuselage is kept to minimum weight, and, since it is so short, is really quite strong for its needs.

The pod attachment was designed to be strong and smooth for the type of fuselage used. The thin fuselage prohibits the use of the standard "piece-X" pod (e.g. the Bumble Bee, Flatcat). The height of the pod appears to be ideal — the wing is undamaged by the engine blast, and boosts are nearly vertical.

#### Construction

The secret of the lightweight wing is a minimal amount of understructure — there are no spars and only 6 ribs. Cut the ribs from 1/8" balsa; anything thinner will not have the compression strength that is needed with a stretched tissue covering. The trailing edge pieces are cut from 1/16" balsa.

The leading edge is cut to the 2-wing length from 1/8" x 3/32" spruce. You need the strength and flexibility of spruce here, and weight this far forward is not important.

After soaking the leading edge in water, carefully mount it on the wing plan using pins on both sides, to hold its curved shape. *Do not put pins into the leading edge!* This will weaken and break it. If you wish to save the plans, be sure to pin a sheet of

waxed paper over them before pinning down the parts. Let the leading edge set until dry but do not remove even then — it will still spring back. The tension is needed to strengthen the wing.

All pieces of the wing are cut out and glued to each other, pinned down to the wing plan. Use Ambroid or other airplane cement — not white glue. *Do not attempt to shape the leading edge, trailing edge pieces, or ribs until after the wing is completed.* It is much easier to do afterwards and shaping the leading edge will prevent it from bending properly when laying it down on the wing plan. Also, do not cut notches for the ribs in the trailing edge pieces until the ribs are fitted on the plan. This makes things fit better and easier.

Dihedral in the wings is not added until

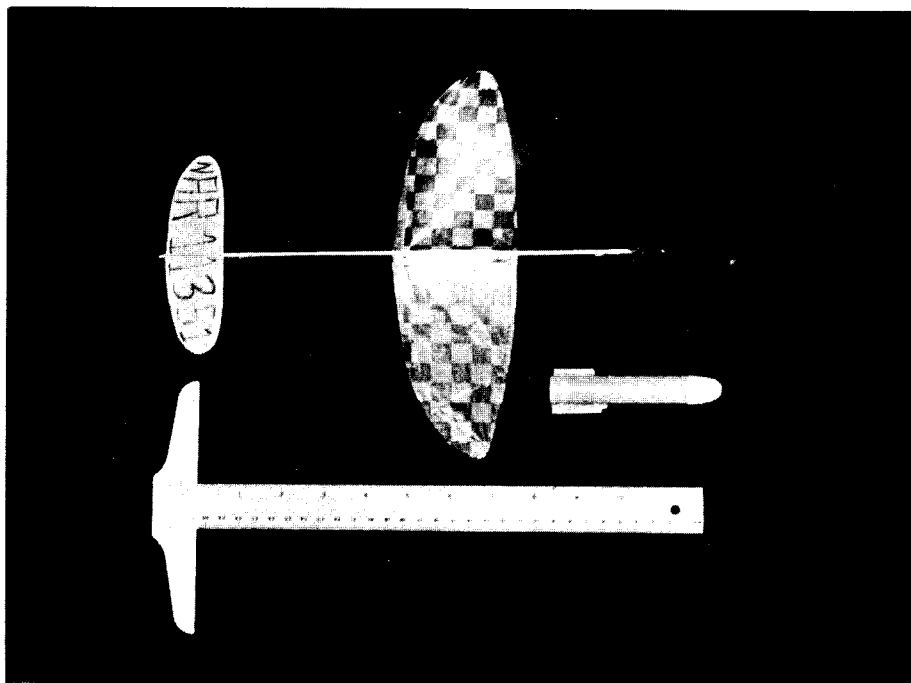

The Butterfly II is a high performance competition boost/glider.

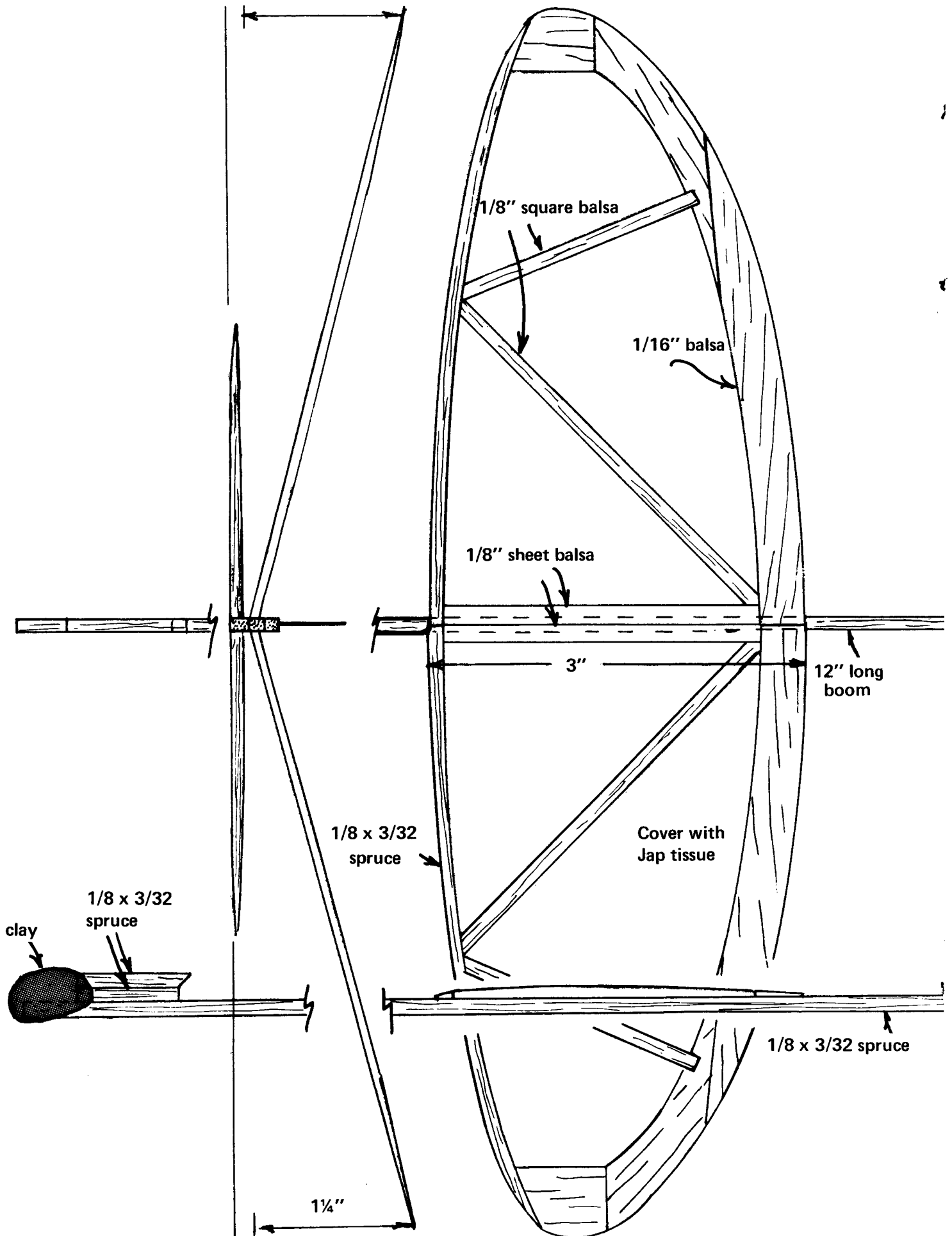

Engine Block  
from BT-20

Estes BT-20 tube

ROCKET ENGINE  
TYPE AND GRADE USE  
1/2 A6-2S

wire cable

elastic cord

2 Pieces 1/8 x 3/32  
spruce — sides from  
1/32 ply

streamer

hollow  
nosecone

1/32" balsa

5"

1/32" balsa

4° stab declinage

---

"BUTTERFLY-II" designed and drawn by T.T. Milkie  
 Hornet Boost/Glide Scale: Actual size  
 Liftoff weight: 20g Glide weight: 5g Empty weight: 9g

---

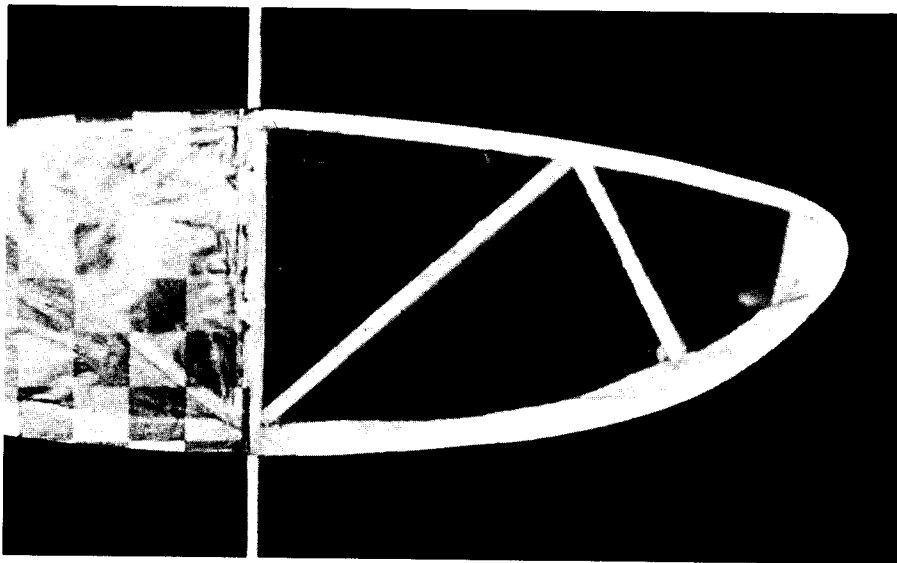

The built-up wing employed on the "Butterfly II" has long been used by model airplane builders to lighten their wing sections. A balsa frame is built, then two supporting braces are added for support, at angles across the frame. The structure feels quite flimsy, but once you add a tissue covering to both sides, the wing is as strong as sheet balsa. In addition the thickness allows a good lifting airfoil to be used on the glider. Test flights with 1/2A engines demonstrate that this structure is strong enough for Hornet Boost/Glide.

after everything is dry and shaped, so the two center ribs and left and right wing trailing edge pieces should be lightly glued together. The wing can then be lifted (with the aid of a razor blade if you glued the wing to the plans!). Now, working only with fine sandpaper, shape the ribs, trailing edge, and leading edge to the plan airfoil. Be careful though — without the tissue covering the wing is very weak.

When this is completed cut the wings apart with a razor saw. Then putting the wing on the edge of a table propped up at the desired dihedral angle, sand the root edge using a sanding block. This is the same procedure used for forming the roots on the Bumble Bee and the Wasp. Glue the roots together with Ambroid and let dry overnight, propped at the proper angle of dihedral.

The wing, after being lightly doped, is ready for covering. The covering material is very lightweight Japanese tissue, available at your hobby shop. First lay the wings on

the tissue and mark around one wing leaving 1/2" extra on all sides. Make 4 of these. (Each panel must be applied separately.) Remember that two of the panels must be mirror images of the other two if the tissue has a color pattern or finish on only one side.

The secret of a good, smooth wing is proper covering procedure. The following method is a standard model airplane procedure, though variations on it might work better for people experienced in built-up structures.

Using a window cleaner bottle, air gun, or even a toothbrush, spray one piece of tissue with water. The water stretches the so that it shrinks properly when dry. Quickly apply clear dope (slopping it on) to the top surface of the ribs and top and bottom of the leading and trailing edges of one wing. Be generous so that the dope doesn't dry out while you're fooling with the tissue. Starting at the root edge, apply the tissue over the top of the wing, working out the

wrinkles. Extra dope can be applied on the underside if necessary. When the water has dried, cut slits in the overhanging tissue with a razor blade. Dope the tissue "fingers" and fold them under the wing.

Now re-wet the covered wing and another piece of tissue and begin covering the bottom of the same wing panel. It is necessary to re-wet the wing to prevent it from warping the frame badly when applying the bottom tissue. Extra dope can be applied to the ribs by putting it on top of the tissue, and working it through the tissue with your fingers. This time do not slit the excess tissue, but let it dry and cut the edges clean with a sharp razor blade.

To further tighten the tissue and strengthen the wing, apply one or two coats of clear dope to it. To avoid warping the wing, you can prevent shrinkage of the dope by adding a small amount of castor oil to it. Some dope manufacturers also sell special dope which does not shrink.

While the wing is drying, cut the vertical and horizontal stabilizers from 1/32" balsa. Sand only a rounded leading and trailing edge on these with very fine sandpaper and apply a few coats of dope for strength. The horizontal tail is attached with a considerable angle of attack (40°). This is to make the glide transition occur rapidly — an important feature on hornet boost/gliders.

The fuselage and pod mount are easily prepared. Use white glue on the spruce joints. The pod is very short and light, and takes a 1/2A short. The engine block is made from a 1/4" section of BT-20. A thin cable (such as 1/4A model airplane control line leadout wire) is looped around the engine block and soldered. A loop on the other end is attached to an elastic cord shock cord. I find that the elastic cord is stronger and more flame resistant than rubber. A short streamer is used for recovery, since a parachute results too often in a "red baron."

### Flying the Model

The built-up wing may develop warps if you are not careful. Careful bending, heating, and wetting can get rid of some of them. Since the glider will always retain some asymmetry, it was not necessary to build the glider to circle. By test gliding it and warping the tail surfaces by breathing on them and bending, it is possible to trim the glide for a good 20 ft. circle.

Nose weight is added as clay on the tip. Be careful not to have the clay interfere with the operation of the pod.

When trimming the glider remember that you should toss it gently into the wind with an air speed about that of the expected glide speed. I've seen too many people trimming their B/G's like they were throwing a baseball. If the wind speed is greater than the glide speed you may even have to throw the glider backwards!

When launching, attach a piece of masking tape to the launching rod and slide the pod down onto it. Then hook the glider onto the pod mount.

The glider was not named "Butterfly" due to its wing shape, nor because it flutters down (which it doesn't). It was called that because on its first flight I kept saying that the boost/glider "better fly!"

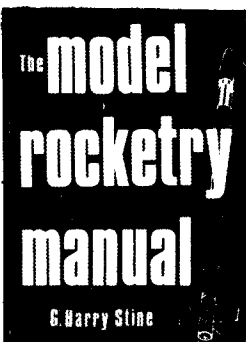

## New Book by G. Harry Stine

How to select and construct model rockets. Safety rules. How to use model rocket motors properly. How to choose and operate launching and firing system. Flight operations: where to fly model rockets, safety procedures, proper packing and recovery devices. Boost-gliders. Effects of wind and weather. 96 pages, fully illustrated.

150

Order from your hobby shop  
or send \$1.50 to:

SENTINEL BOOKS Dept. MR  
17 East 22 St., N. Y., N. Y. 10010

MODEL ROCKETRY: "Flight test: strongly recommends this book to all new rocketeers . . . will save you many hours of trial and error experimentation."

# Edison Rocket Center

DEPT. MR, 238 PLAINFIELD AVENUE, EDISON, NEW JERSEY 08817

ALL ADVERTISED ITEMS ARE IN STOCK - MAIL ORDER SPECIALISTS - QUICK MAIL SERVICE

BODY TUBES				
Size	ID(in.)	OD (in.)	Wall Th.(in.)	Price
<b>ESTES</b>				
BT-5	.515	.541	.013	.30
BT-10	.710	.720	.005	.30
BT-20	.710	.736	.013	.30
BT-30	.725	.765	.021	.30
BT-50	.950	.976	.013	.40
BT-55	1.283	1.325	.013	.60
BT-60	1.595	1.637	.021	.85
BT-70	2.175	2.217	.021	.85
BT-101	3.895	3.938	.021	1.75
<b>CENTURI</b>				
ST-518	.515	.543	.014	.30
ST-718	.715	.759	.044	.30
ST-818	.865	.908	.043	.35
ST-1018	1.000	1.040	.040	.40
ST-1318	1.300	1.340	.040	.60
ST-1618	1.600	1.640	.040	.65
ST-2018	2.000	2.040	.040	.85
<b>SAI</b>				
T-19	.716	.748	.016	.30
T-20	.747	.787	.020	.30
T-22	.864	.890	.013	.35
T-23	.894	.920	.013	.40
T-28	1.032	1.102	.035	.40
T-30	1.149	1.181	.016	.45
T-30B	1.121	1.181	.030	.60
T-45	1.732	1.772	.020	.60

(All body tubes are in 18" lengths.)

### Mail Order Specials

- 4 Photo Flash Batteries (Regular price .39 each) **only \$1.00**
  - 100 ft No. 32 Nichrome Wire (Regular price 2.85) **only \$1.50**
- (Only available on orders of \$5.00 or more.)

Most parts, nose cones, adapters, fins, etc. from MPC, Estes, SAI Centuri, CMR, etc. are available. Order by part number.

MPC				
R-841 Moongo	2.00	K-42 Orbital Transport	3.25	
R-842 Redstone Quasar	2.00	K-44 Birdie	.60	
R-843 Pegasus MK-II	2.25	K-45 Beta	1.50	
R-844 Martian Patrol	3.00	K-46 Shrike	4.75	
R-845 Aquarius	2.00	K-47 Cherokee-D	2.75	
9000 Vostok RD-107	4.00	K-49 Sprint	1.75	
9002 Titan II	4.00	K-52 Omega	3.50	
R-846 Nike Smoke	1.00	K-29 Saturn 1B	1.95	
R-847 Star Hawk	1.00	K-36 Saturn V	13.50	
R-848 Tomahawk	2.00	K-43 Mars Lander	6.00	
R-849 Nike Patriot	3.00	K-48 Bandit	3.75	
R-300 Yankee I (Assembled)	4.00	K-57 Skydart	3.95	
		K-58 A-20 Demon	3.95	
		K-2A Mark II	1.35	

Most catalog item available, order by part number.

Estes				
K-1 Astron Scout	.70			
K-2 Astron Mark	1.25			
K-3 Astron Space Plane	1.80			
K-4 Astron Streak	.70			
K-5 Astron Dodge II	2.00			
K-6 Astron Ranger	3.00			
K-7 Astron Phantom	1.75			
K-8 Astron Sky Hook	1.35			
K-9 Astron Space Man	.75			
K-10 Astron Cobra	3.00			
K-11 Wac Corporal	1.50			
K-12 Astron Farside	2.75			
K-13 Astron Falcon	1.00			
K-14 Astron Drifter	1.75			
K-15 Astron Sprite	1.00			
K-16 Astron Delta	2.25			
K-17 Aerobee 300	2.00			
K-18 Astron X-Ray	1.75			
K-20 Mars Snooper	3.25			
K-21 Gemini Titan GT-3	5.25			
K-22 V-2	2.00			
K-23 Big Bertha	3.00			
K-24 Astron Gyro	1.25			
K-25 Astron Alpha	1.50			
K-26 Arcas	2.25			
K-27 Honest John	2.00			
K-28 Thor Agena-B	3.25			
K-30 Little Joe II	3.25			
K-31 Star Blazer	1.25			
K-32 Astron Starlight	2.35			
K-33 Astron Trident	4.00			
K-34 Astron Nighthawk	2.00			
K-35 Astron Constellation	2.00			
K-37 Astron Scrambler	4.25			
K-38 Astron Avenger	3.25			
K-39 Saturn V Semi-Scale	3.50			
K-40 Astron Midget	1.25			
K-41 Mercury Redstone	3.50			

KS-10 Saturn IB	9.95	Fiberglass Recovery Wadding (6 by 6 by 1")	.35
KS-12 Saturn V	16.95	LBP Shock Sponge (4 1/2 by 5 by 3/8")	.25
KS-15 Nike Smoke	3.50	Adjust-A-Roc	6 for .25
ALT-1 Sky Track Single	24.50	Payload Weight 1 Oz.	.50
<b>Silk Parachutes</b>			
PS-12 12 Inch	1.90	Experimental designer's Kit for Advanced Model Rocketeers- \$16.00 Value-	9.95
PS-18 18 Inch	2.75		
PS-24 24 Inch	3.50		
PS-30 30 Inch	4.50		
PS-40 40 Inch	7.50		
Most catalogue items available, order by part number.			
<b>Model Rocket Contest Products</b>			
<b>1/4 mil. Plastic Parachutes</b>			
24 inch	.35		
30 inch	.45		
36 inch	.55		
<b>1/4 mil. Aluminized Mylar Parachutes</b>			
20 inch	.70		
30 inch	1.25		
36 inch	1.50		
<b>MPC</b>			
R-204 Lambda Payload	1.50		
R-205 Icarus C	1.50		
R-207 Theta-Cajun	2.00		
R-209 Microsonde III	3.00		
R-211 Zenith II Payloader	3.00		
R-212 Flare Patriot	2.00		
R-215 Lunar Patrol	3.00		
R-216 Flat Cat	2.50		
R-810 Pioneer I	1.00		
R-822 Redstone Maverick	1.50		
R-823 Viper	1.70		

Competition Model Rocket				
BG-1 Manta	2.50			
C-1 Brake-Away	2.50			
C-2 Hyper	2.95			
C-3 Elo (Egg Lofter)	4.25			
C-4 Effy	1.60			
C-5 Rapiet	1.95			
C-6 Marcus	1.00			
C-7 D Region Tomahawk	4.50			
BT-1 Tube Cutter	1.75			
34A Fin Guide	2.00			
<b>Bo-Mar</b>				
Alpha I	\$1.95			
Spartan	2.00			
Alpha B	1.95			
Swift	1.50			
Astro-Quest	2.00			
<b>Semroc</b>				
Sigma II	1.98			
Lune RI	2.98			
XK-23	1.98			
Apheleon	1.98			
Swift	1.49			

<b>Books</b>				
Handbook of Model Rocketry	6.95			
Model Rocketry Manual	1.50			
<b>Glue</b>				
Hobbyoxy Formula 1 Cures 1 hour	1.00			
Hobbyoxy Formula 2 Cures 3 hours	3.00			
Hobbyoxy Formula 4 Cures 15 minutes	2.00			
Testers Wood Glue	.15			
Ambroid	.25			
Ambroid	.39			
Elmers	.29			
Elmers	.59			
<b>Paints</b>				
Testors Dope 1 oz.	.25			
Testors Dope 4 oz.	.69			
Testors Dope				
Testors Thinner 1 oz.	.25			
Testors Thinner 4 oz.	.60			
Rubbing Compound	.85			
Finishing Wax	.85			
<b>Balsa</b>				
3/32 by 3 by 12"	3 for .60			
1/8 by 3 by 12"	3 for .70			
1/16 by 3 by 12"	3 for .55			
Fireproof streamers	.35			

**Hawk B/G**  
by SAI



**FREE!!!**

Wing Span	10 inches
Length	11 inches
Diameter	750 inches
Weight	5 ounces

All orders over \$5.00 will receive a free Hawk kit.

# PAPER FINS

## For Nikes and other Scale Birds

by George Flynn

The "built-up" fin technique, demonstrated by Howard Kuhn at the 1971 Pittsburgh Spring Convention, offers several advantages over solid balsa in making fins for scale models. Fins for the Nike, Aerobee, Tomahawk, and other missiles using all flat surfaces (with no curved airfoils) can easily be fabricated from light cardboard. This material is easier to finish and stronger than comparable balsa fins. In addition, the paper fins can be constructed with a sharper and straighter leading edge than is possible with wood fins.

Materials for construction of paper fins are readily available. Manila file folders or white index cards are used as the basic fin material. In addition, a balsa spar is used inside each fin to provide support. The only other materials needed are a pair of scissors, a sharp X-Acto knife, non-water-base glue, and sanding sealer.

The procedure shown here is for a standard Nike fin as used on many NASA Nike boosters. This technique can also be used on most other sounding rocket fins. To modify it for the D-Region Tomahawk (MRm, June '71), two balsa spars would be used — one at the trailing edge, and the other at the forward break line — and the scribe line is located at the break line.

Scale modelers will find the paper fin technique a welcome relief from the pain of sanding the correct airfoil on thin balsa fins. With a little practice, a set of four scale paper fins can be constructed in only two to three hours.

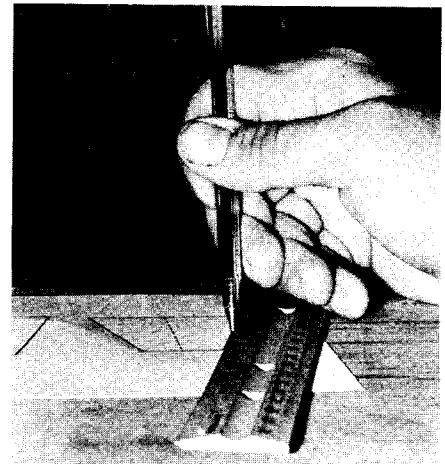

1. Using a light colored pencil or pen, mark the fin pattern on a sheet of light cardboard. (Be careful to cut the fins slightly oversize to allow for the bend.) Mark the high-point or "break" lines on the fin.

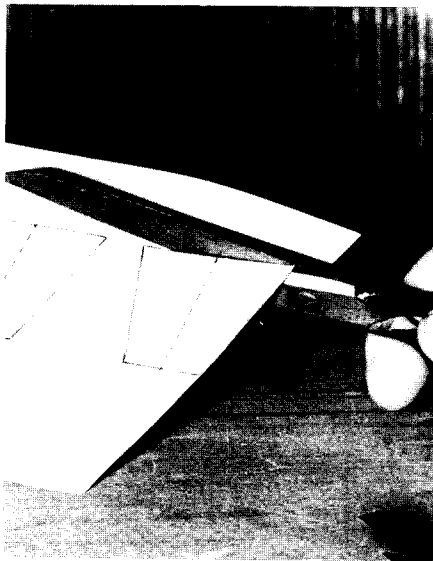

2. Cut out the fin to the pattern marked. By marking the lines slightly oversize, and cutting inside the lines, you will eliminate some finishing work in painting over these lines.



3. Use a sharp X-Acto knife to scribe a line on the high point. The cut should be made only half-way through the card.

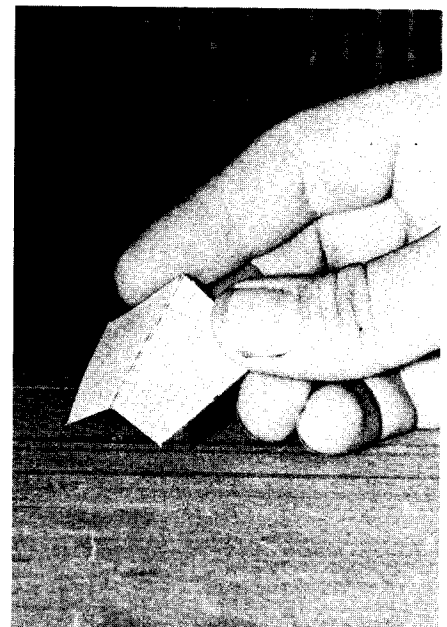

4. Carefully bend the card stock along the scribed line.



5. Apply a bead of non-water-base glue (such as Se-Cur-It or epoxy) to the inside edges of the fins, and spread it into a thin film.

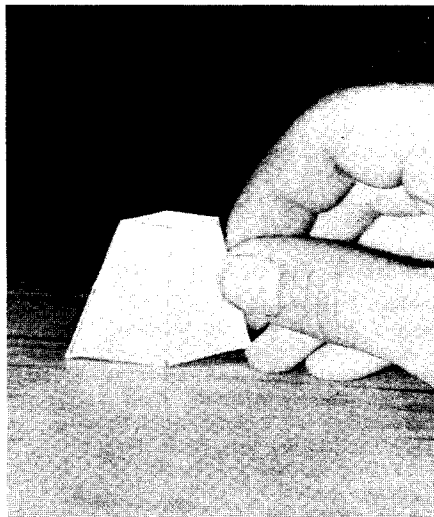

6. Align the two fin sections, and run your fingers up and down the fin edges to attach the leading and trailing edges.

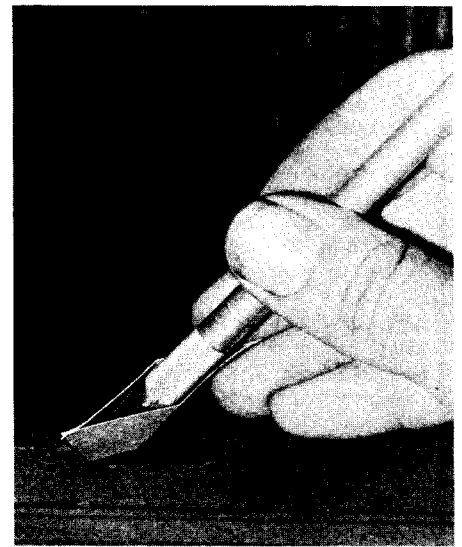

7. Spread the center apart to provide a sharp clean edge glue joint. Set aside to dry.



8. Cut a balsa strip to the correct thickness to serve as a center spar. Glue both sides of the spar. Insert the spar.

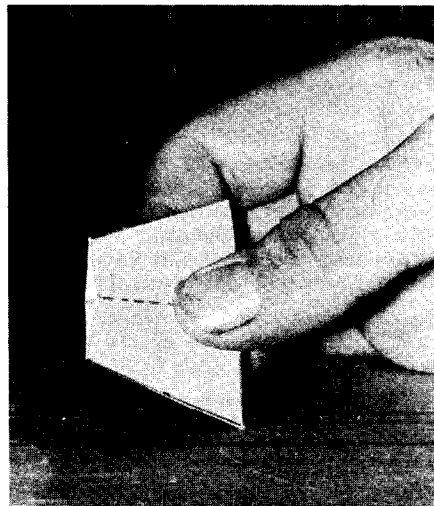

9. Hold both sides of the fin together until the glue on the spar sets. (Again use non-water-base glue.)



10. Use glue, wood filler, or Hobby epoxy "stuff" to fill in the tip edge of the fin. Do the same to the root edge.



11. When the edge fillets have dried, use 400 grit sandpaper to smooth the edges.



12. If there is no scribe line at the high point on the prototype, fill the scribe line with sanding sealer and sand smooth.

The paper fin is now ready for attachment to your rocket. A thin coating of epoxy glue is applied to the root edge, and the fin is applied to the rocket body. These fins should not be filleted (unless fillets are used on the actual rocket). Any type of paint suitable for use on paper can be used to finish these fins, including the acrylic fluorescent paints now on the market.

When used on a large model, such as a 1/10 scale Nike Smoke, super-detailing can be done on the paper fins. Recessed rivets or bolts can be simulated by lightly punching the surface of the fin with a sharp nail. Raised rivets or bolts require punching from the other side before the fin sections are glued together (step 5). In either case, be careful not to push the nail all the way through the fin.



**NSSR-71** — July 17, 1971. Regional Meet sponsored by the North Shore Section of the NAR, open to all NAR members from the New York, New Jersey, and Connecticut area. Events: Scale, Eagle B/G, Sparrow B/G, Streamer Duration Class 1, Open Spot Landing, Class 0 PD. Registration Deadline: May 22, 1971. Contact: Kevin Clark, 167 Dorchester Rd, Garden City, NY 11530.

**Southwestern Model Rocketry Conference** — July 20-23, 1971. Third annual convention for rocketeers in the Southwestern U.S. Featuring: flight competition, discussion groups, speakers, films, and banquet. Sponsored by the ARC-Polaris Rocket Club, Portales, New Mexico. Write for information: ARC-Polaris, Drawer 89, Portales, N. Mex. 88130.

**East Penn-2** — July 25, 1971. Area meet sponsored by the Pottstown Missile Minders of Pottstown, Pennsylvania. Events: Ostrich Eggloft, Class 1 PD, Class 2 PD, Class 2 Streamer Duration. Contact: Carl J. Warner, 665 Woodland Avenue, Pottstown, Pennsylvania 19464.

**TCIRM-1** — August 21-22, 1971. Tri-County Invitational Rocket Meet open to all rocketeers in the Colorado area. Sponsored by the Model Rocket Club of Thornton, Colo. Site: Adams County Fairgrounds. Events: Class 2 PD, Scale, Sparrow B/G, Single Payload, Robin Eggloft, and Open Spot Landing. Contact: Tom Sloan, 2081 Hoyt Dr., Thornton, Colo. 90229. (Advance registration before August First is required.)

**AARM-2** — August 21-22, 1971. The Second Annual Alberta Regional Meet is open to all rocketeers from Alberta, British Columbia, and Saskatchewan. Events: Class 1 Altitude, Class 1 PD, Pee Wee Payload, Pigion/Ostrich Eggloft, Swift B/G, Hawk B/G, Scale, Parachute Spot Landing. Site: Edmonton, Alberta. Contact: AARM-2, 10635 - 48th St., Edmonton 80, Alberta, Canada.

**FLAM** — August 28-29, 1971. Area meet sponsored by the Upper Arlington Rocket Club in Hilliard, Ohio. Events: Hornet B/G, Sparrow B/G, Sparrow R/G, Class I PD, Class II Streamer Duration, Design Efficiency, Robin Eggloft, Pee-Wee Payload, Open Spot Landing. Contact: Fred Long, 456 Bigelow Dr., Hilliard, Ohio 43026. Phone: (614) 876-7628.

**NYRS-1** — September 4-5, 1971. Sponsored by the New York Rocket Society. Features: Contest, Discussion Groups, R&D Presentations, Banquet. Open to all rocketeers. Contact: James Enny, 88 Tehema St, Brooklyn, New York 11218.

**Wisconsin Area Meet** — September 18, 1971. Contest, sponsored by the Mariner Rocket Society, open to all NAR

members from the state of Wisconsin. Events: Class 0 PD, PeeWee Payload, Robin Eggloft, Hornet B/G, and a non-sanctioned Payload Boost/Glide event. Contact: Russ Schmunk, 118 Highland Street, Whitewater, Wisconsin 53190.

**Montreal Eggloft '71** — September 18, 1971. Regional Egglofting competition in Montreal, Canada. Site: Maisonneuve Park complex, Montreal. For rules and information write: ARRA, 7800 des Erables Ave, Montreal 329, Quebec, Canada.

**WESNAM-3** — September 26, 1971 at Bridgewater, Mass. Area meet for rocketeers in Mass., RI, NH, Me, and Conn. Events: Condor R/G, Class 4 altitude, Hornet B/G, Robin Eggloft, and Plastic Model. Contact: Trip Barber, c/o MIT-MRS, MIT Branch P.O. Box 110, Cambridge, Mass. 02139.

**NETS-2** — November 6, 1971. North East Technical Symposium sponsored by the Pascack Valley NAR Section. Site: Bloomfield, New Jersey Public Library. Tentative topics: Scale, B/G, Making Your Own Decals. Contact: Brian Skelding, 9 Appleton Rd., Glen Ridge, New Jersey 07028.

**ATTENTION CONTEST DIRECTORS**  
Mail notices of your contests at least 90 days in advance for listing in Model Rocketry's "Modroc Calendar" to:  
Modroc Calendar  
Model Rocketry Magazine  
Box 214  
Astor Station  
Boston, MA 02123

## TECHNICAL REPORT:

... THE FIRST IN A SERIES OF TECHNICAL REPORTS FOR ADVANCED ROCKETEERS ...

# FUNDAMENTALS OF DYNAMIC STABILITY

BY GORDON K. MANDELL

30 PAGES, ILLUSTRATED

ONLY \$2.50 PPD.

ORDER FROM: TECH REPORT, MRm, BOX 214, ASTOR ST., BOSTON, MA 02123

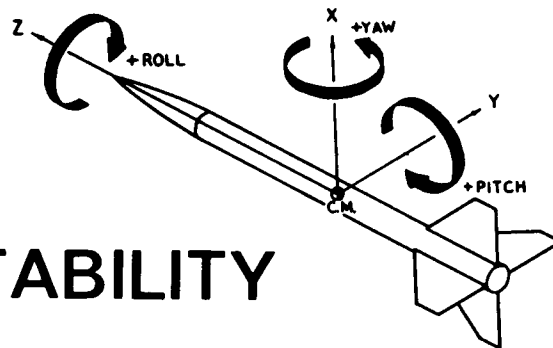



# UPDATE CANADA

## Funtastic '71

If you have done something or will be doing something that you consider 'funtastic' this summer, we at *Update* would like to hear about it.

From stories and pictures of summer experiences we hope to be able to print a year end summary of activities in Canada in the December issue. But remember, if we don't hear anything from you, we won't be able to print it.

UPDATE CANADA  
FUNTASTIC '71  
7800 des Erables Avenue,  
Montreal 329, Quebec

## Montreal Eggloft '71

This is a really different type of competition. A competition devoted entirely to egglofting. Several discussions are planned on the techniques of egglofting, and the prizes are something else.

The event is scheduled for September 18th, and information can be obtained through *Update Canada*. We might add that the event is open to all rocketeers in Canada and the U.S. who can make it.

For more info write:  
ARRA  
7800 des Erables Ave.  
Montreal, 329, Quebec

## Club Registration

If you have a club we would like to know about your activities. So, as soon as possible send us the name of your club and tell us what you've been doing.

A new rocket club is being formed in Toronto. Interested rocketeers are invited to contact the Don Valley Rocketry Association, 141 Sweeney Drive, Toronto 375, Ontario, Canada.

A model rocket club has been formed in Youngstown, Alberta. This club is called the RAY - the Rocketry Association of Youngstown. The club has two flying fields with full launch facilities. Interested rocketeers can contact Neil Ruppert, Box 87, Youngstown, Alberta, Canada.

## Why Not Get the 'Red and White' Off the Ground?

If Canadian rocketeers are ever to become recognized at international conven-

tions, we must ourselves feel as individuals representing Canada. When decorating a rocket, most Canadian modelers will use the words 'UNITED STATES.' I have, personally or publically, nothing against the United States, but I fail to see why Canadians don't label their birds with 'CANADA,' or put on a Canadian flag, or simply the maple leaf. The absence of such markings on a scale model is only normal, but what about the remaining rockets?

An American modeler having read this far, probably thinks that I am some fanatic on Canadianism. However, he'll have to admit that having his country's name on something, no matter what it may be, will make him respect that object much more. In reference to a rocket, he'll only put the best material on it and build it with extreme caution. I don't claim to be a psychologist, but you build a better, if not fantastic, model when you plan to put your country's name on it.

Many Canadian rocketeers will give the excuse that decals with the name 'CANADA' or the Canadian flag cannot be found. To that I can only reply that they have not bothered themselves to look around. Admitting that decals with 'CANADA' are hard to find, every hobby shop carries a supply of assorted letters which can be used to form the right combination. As for the flag itself, I know of several places in Montreal alone where it can be purchased.

It is actually a pity when we, as Canadians, think that the only Canadian symbols at the First Canadian Model Rocket Convention were supplied by the organizers themselves. Only one rocket, a scale Black Brant, had a maple leaf on it, probably because it was an absolute necessity seeing the rocket was entered in scale. No one had a flag decal or arm patch which was Canadian, whereas one of the contestants from Rochester N.Y. had an arm patch of the American flag.

Encouragement to this unfortunate situation can be seen at certain instances. An example is the name of the robin egglofter designed by Peter Sauer; Beaver 1C, *definitely Canadian*. (December 1970, MRM)

The Canadian involvement in space is relatively small compared to that of the U.S. Program, but rocketeers can be proud of several other achievements. We now have a series of domestic satellites, Alouette and Isis. Heroux Ltd., located in Montreal, built several important components of the LM landing gear, a firm in Toronto built the electronic circuits which were used in one of the lunar experiments during the Apollo 14 mission, and there are others which will probably never be mentioned.

In this article on Canadian 'fierte,' in rocketry, my purpose is not to knock anyone down. I simply want to arouse Canadian rocketeers to put their country's colors on

their birds. Try to get some 'red and white' up at your next launchings and happy flying!!!

Richard Carmel '71

## Book Nook

**Upper Atmosphere & Space Programs in Canada** by Chapman, Forsyth, Lapp, Patterson  
1967 - Cat. No. SS21-1-1.- 258 pgs - \$2.50

A technical study commissioned by the Science Secretariat and presented to the Science Council of Canada on January 16, 1967. Although it is several years old, it does serve as good background material of Canadian activities of the 60's. Outlines the Alouette-ISIS programs, the Black Brant program, the HARP-McGill project, the Churchill Manitoba rocket range, etc . . . A very interesting book.

**White Paper on a Domestic Satellite Communication System for Canada** by Hon. C.M. Drury, Minister of Industry  
1968 - Cat. No. CP22-968 - 94 pgs - \$1.00

Reviews the main factors involved in planning and establishing a domestic satellite communication system to meet the needs of Canada, both in the immediate future and over the long term.

Both books available from:  
INFORMATION CANADA,  
Daly Building  
Corner Mackenzie and Rideau,  
Ottawa, Ontario

## Rutherford

This Spring the Canadian Post Office issued a stamp in honour of Lord Ernest Rutherford (1871-1937). This New Zealand physicist is remembered today for his intensive work in the Nuclear Sciences, specifically the radioactive phenomena. In 1908 he was awarded the Nobel Prize in Chemistry.

Of what importance is his work in reference to rocketry? To model rocketry, probably not much, but in the next decade the space programs (America's and the Soviet Union's) will enlarge on the use of nuclear propulsion in space vehicles. When the first nuclear engine is put in space we will then realize the greatness of Rutherford's research and others like him.

# PERIHELION-FOUR

## COMPETITION EGGLOFTER

*Designed by Larry Shenosky*

As a general payload carrier or a competition egglofter, the Perihelion will perform as a winner. The capsule is large enough to accept a "grade A large egg" with plenty of protection. The 1" diameter body tube is sufficient to accept most of today's high-powered engines, such as the Estes D, the Flight Systems D, as well as the C engines and the Cox D with an adapter.

The reduction from payload section diameter to the BT-50 (engine size) tube is necessary to reduce pressure drag, by decreasing the amount of turbulence behind the

rocket. Many high-performance egglofters use a long shroud "to make a smooth transition between the body diameters." The Perihelion transition is only 2 inches long. The turbulence is slightly greater, but the total surface area of the rocket is reduced considerably, since the shroud is very short, thus reducing *friction* drag.

The fins are trapazoidal in shape. Many people swear by elliptically-shaped fins to reduce drag. However, the trapazoidal fins, with the corners slightly rounded, are easier to construct, stronger, and have only a very slight bit more drag.

### Construction

The payload section shown is designed for a minimal weight egglofter. For lifting other payloads, the dimensions and hollowing need not be followed exactly. By hollowing the shroud and nose cone as shown it is possible to put a large portion of the egg and padding in the hollowed area. When packing the egg remember that you *don't* want the egg to move under impact. That would only add the force of inertia to the egg and possibly break it. Bits of foam rubber should be packed so that the egg is *firmly* supported in the payload section. You'll break more eggs by providing too little cushioning material than you will by providing too much.

The body tube is cut to 9". If you try to make it shorter, you are only reducing the chances of getting your parachutes out — and it's not worth it. Also, a very small egglofter is hard to see — a consideration to be weighed against the small reduction

in weight and drag.

The recovery system consists of 2 18" chutes — one for the rocket and one for the capsule — so that the two will come down separately. A single 24" chute could also be used. Be sure to cut a spill hole in the chute to increase stability. If you use only one chute you will need a strong shock cord. Since this is where many rockets fail, it is advisably to use strong *elastic* cord, not rubber. Also, make it at least 24" long to prevent the payload section from snapping back and damaging the body tube. Attach the shock cord to the body tube with a paper mount or by gluing under the engine block.

Cut, shape and attach the fins to the body tube. When dry add lots of fillet. This reduces drag, and more importantly, adds strength. After sealing the fins with balsa filler, glue on a launch lug as shown. Also attach a lug to the payload capsule with plastic cement.

Paint the model as shown in the drawing, or with your own preference. If it is for competition, the choice of color scheme can be crucial. All black is a well-tryed color and can be seen well in the sky.

### Flying

When packing the chute(s) don't skimp on the wadding. If you do you may use up a lot of chutes (and eggs!). The egg is inserted by removing the nosecone. For the sake of the crowd, add a strip of cellophane tape around the nose cone shoulder to tighten the fit on the nose cone. When you eject the parachute *do not eject the egg!*

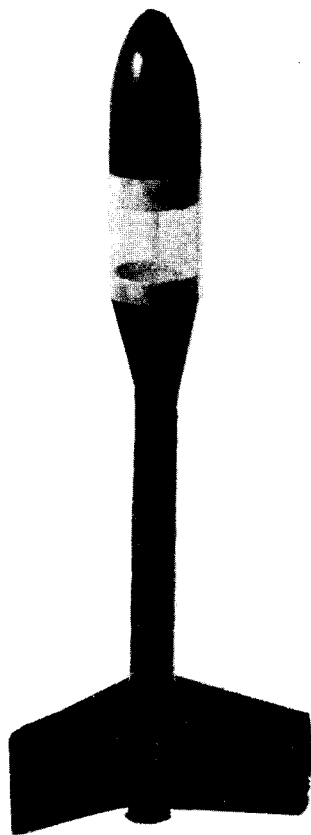

The short payload shroud on the Perihelion Four helps reduce surface drag and results in a simpler model. Note the unique decal on the fin.

### PARTS LIST

Part Description	Part No.	Size
Payload Section (1.75 inches inside diameter for egg)	Estes PS-50E	8¼ inch length
Body tube	Estes BT-20	9 inches long, 1 inch dia.
Fin material (balsa)	----	1/8" x 3" balsa
Shock cord (elastic cord, not rubber)	----	1/8" x 24"
Parachutes (2 is best for egglofting)	Estes, Centuri or other	18" diameter
Engine block (use an adapter)	Estes AR-20-50	1" diameter
Launch Lug (use 2)	----	2" each
Egg	----	Grade A large

# THE PERIHELION FOUR

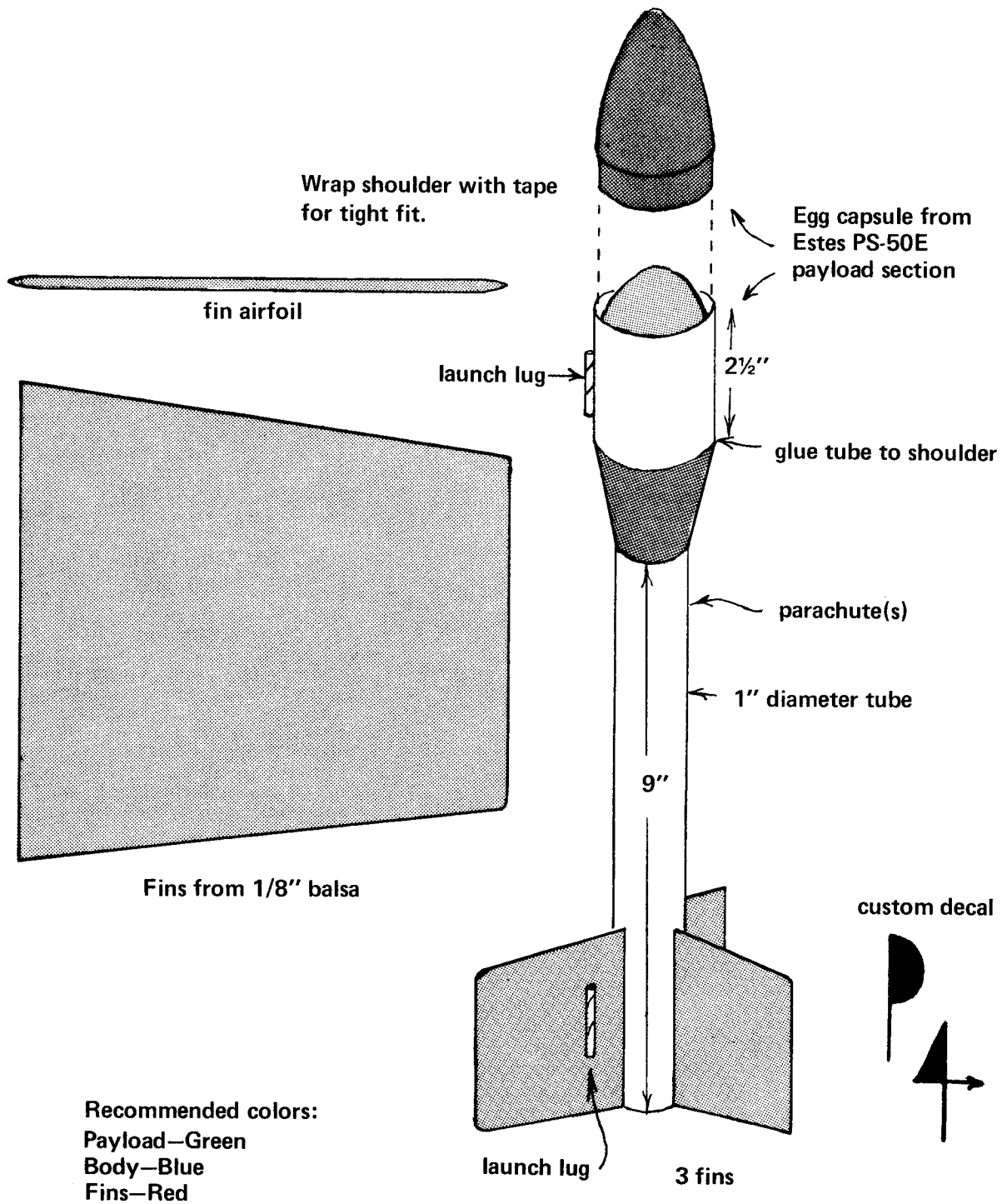

RADIO-CONTROL  
ODD-BALL

MODEL ROCKET ELECTRONICS  
TECHNICAL ARTICLES

# Back Issues!!!

COMPETITION

BOOST-GLIDERS

TRACKING SYSTEMS

CAMERA ROCKETS  
FINLESS ROCKETS

PAYLOAD ROCKETS

SCALE MODEL ROCKETS

LAUNCH SYSTEMS

CLUB NEWS

## SUPPLY LIMITED

## ORDER TODAY!

**November 1968** \$ .75   
Model Rocket Recovery by Extensible Flexwing . . . High Quality Aerial Photography: Part I . . . Calculating Drag Coefficients . . . Scale: MT-135 . . . Project Apollo . . . XR-5C: Three-Stage Cluster . . . The Versitex: Payloader

**February 1969** \$ .75   
Zeta: Single-Stage Sport Rocket . . . The Flight of Apollo 8 Non-Vertical Trajectory Analysis . . . The Old Rocketeer: The Manufacturers . . . E Engine Cosmic Avenger . . . Scale: Nike-Deacon . . . Model Rocketry for the Depraved . . .

**March 1969** \$ .75   
Saffek's Saturn . . . High Quality Aerial Photography, Part III . . . The Bifurcon Rocket Design . . . A \$25 Club Launch Panel . . . How to Finish a Model Rocket . . . Scale: Genie MB-1 . . . The Dynaflora Sport and Payload Rocket

**April 1969** \$ .75   
Scale: Arcas . . . Apollo 9 . . . Demonstration Launches Payload Rocket Design . . . Multistage Altitude Calculations Tower Launching . . . Torsion Wire Experiments . . . The Skyray Design . . . Chicago Trade Show . . .

**May 1969** \$ .75   
Staged vs Cluster Rocket Performance . . . The Fra-jyle: Sport Rocket . . . Astroscale: ASP . . . Transmitter Plans The Infinite Loop: Oddball design . . . The WRESAT Australian Satellite . . . Pittsburgh Convention . . . The Hawk Sport Rocket . . . Closed Breech Launching . . .

**July 1969** \$ .75   
Soviet Space Program . . . Scale: Astrobee 1500 . . . ECRM 3 Results . . . F Engine Saturn . . . Misfire Alley System The Goliath . . . The Why(?)gion . . . Spin Rate Sensor and Direction Sensor for Model Rocket Transmitter . . .

**August 1969** \$ .75   
Radio-Controlled Boost/Gliders . . . A History of Retro-rockets . . . Accelerometer for Rocket Transmitter . . . Results from WAMARVA-1 . . . The Dynamite . . . Scale: Rohini RH-75 . . . The Flat-Cat B/G . . .

**September 1969** \$ .75   
Color Aerial Photography . . . Apollo 11 . . . Astroscale: Black Brant III . . . Southwest Model Rocket Conference Transmitter Rocket . . . Czech National Championships . . . Plastic Scale Modeling . . . Radio-Controlled B/G's, Part II

**October 1969** \$ .75   
Conical Model Rockets . . . Astroscale: Nike-Smoke . . . Fin Test Vehicle . . . Foxmitter Microphone . . . NARAM-11 RC B/G, Part III . . . Japanese Rocketry . . . Dragbrakes . . .

**November 1969** \$ .75   
Scale: Nike-Apache . . . Midwest Regional Report . . . Ball-Hagedorn Open Payloader . . . Arcturus: Finless Design . . . Plastic Jupiter-C . . . Wash State Meet . . . Krushnik Effect

**January 1970** \$ .75   
Return to Green Mountain . . . Titt-a-Tower . . . B/G Performance . . . MARS-4 Results . . . Retro-Rocket . . . Calculating Drag Coefficients . . . USSR Championships . . . Modrocs in Vietnam . . . Micron II . . . Scale: Pershing 1 . . .

**February 1970** \$ .75   
Ram-Air Guidance . . . Yugoslav Parachute Duration Design Computer Altitude Calculations . . . Warwick II . . . B/G Performance, Part II . . . Constructing Body Tubes . . . Helicopter Recovery Systems . . . Super-Swift Double B/G . . .

**March 1970** \$ .75   
Flight Conversion: LEM . . . B/G Performance, Part III . . . Plastic Fin Modifications . . . Parallel Fins . . . Ram-Air Guidance, Part II . . . Estes D Engine Altitude Charts . . .

**April 1970** \$ .75   
Modroc UFO's . . . Scale: HAD Australian Rocket . . . Trade Show Report . . . Rear Ejection Clip . . . Psionic Control . . . Drag Coefficient Determination . . . NARWHAL Design Efficiency Plans . . . D Engine Performance, Part II . . .

**May 1970** \$ .75   
Thunder-Bird Eagle B/G . . . The First Model Rockets . . . Scale: USSR Vostok . . . Paint Compatibility Chart . . . The Omega Quadrathon . . . Trojan Fin Test Vehicle . . . Optical Telemetry . . . Nighthawk B/G Wind Tunnel Analysis . . .

**June 1970** \$ .75   
Flying Saucer . . . Plastic Conversion Saturn V . . . Saffek's Jiskra Czech B/G . . . Simplified PD Analysis . . . Styrofoam Wing B/G . . . Pittsburgh Convention . . . Build the Sport The Foxmitter II Modroc Transmitter . . .

**November 1970** \$ .75   
Astroscale: Astrobee-D . . . Finless Payload Bird . . . 5¢ Glider Parasite B/G . . . Capacitor Discharge Guidance . . . Fin Repairs . . . NARAM-12 . . . Flying Apollo Capsule

**January 1971** \$ .75   
Saucer Wing B/G . . . Converting the Space Clipper . . . B/G Wing Construction . . . Tri-Sec II Results . . . Sound-Cineroc System . . . B/G Stability . . . Microphone for Foxmitter II

**February 1971** \$ .75   
The First Clustered Rockets . . . World Meet . . . 3D Open Payloader . . . MARS-5 Results . . . World Meet . . . Closed Breech Egglofter . . . Altitude Loss by Varied Ejection Time

**March 1971** \$ .75   
The Firefly Beacon Sport Model . . . Plastic Saturn V . . . Asp Launcher . . . Valkyrie Hornet B/G . . . Ejection Heat Sink . . . Moonraker Sport Design . . . Whistle Rockets . . .

**April/May 1971** \$ .75   
Metallizing Scale Birds . . . Space Dart Hawk B/G . . . ZNT Oddball . . . Trade Show Report . . . Demo-1 Sport Model Computer Program for Model Rockets . . .

**June 1971** \$ .75   
Scale: D-Region Tomahawk . . . Redwing Sparrow B/G . . . Czech Championships . . . Pittsburgh Convention . . . Flow Pattern Visualization . . . Apollo 14 . . . The Albatross . . .

**July 1971** \$ .75   
East Coast B/G Championships . . . Sky Surfer Foam-wing B/G . . . MIT Convention . . . Enayar PD . . . Drag Reduction by Boat Tailing . . . Time-Thrust Curve Approximation

Add 25¢ to each order for postage and handling.

Allow at least 6 weeks for delivery.

Model Rocketry Magazine  
Box 214  
Boston, Mass. 02123

Name.....

Address.....

City.....State.....Zip.....

# PAR-II

by Mike Poss

Once again, the Titan NAR Section of West Covina outdid itself in hosting the second successful Pacific Area Regional meet. This year's contest took place during the weekend of April 3 and 4, 1971 at the Titans' Galster Wilderness Park launch site in the hills of West Covina. Contest Director Norm Wood ran the meet for over 100 contestants from the Pacific Division. PAR-2 could just as well have been called Sunburn-2 because 90+ degree temperatures prevailed during both days of the meet along with a slight easterly breeze and light smog. All in all, the weather situation was great for rocket flying and (unfortunately) for some fantastic sunburns.

Competition started early Saturday morning with a meet briefing by Norm Wood. Then, information and flight card packets were given out to each participant through his Section Advisor. As explained at the briefing, the launch facilities were the same as those used at PAR-1: dual rack right-field and left-field launchers, and special tower or rail pads that were set up in center-field of the part-time little league baseball diamond. Events for the day were Robin Egg Loft, Class 0 Drag Efficiency, and Hornet Boost/Glide. Scale and Super Scale entries

were turned in to the judges' booth by about 10:00 when firing actually began for the other events.

With the start of the Drag Efficiency event, contestants brought forth their elliptically finned, no-launch-lug models to try to out-streamline the competition. For this event, Brad Beebe of the Delta-V section developed what he calls the "Blow-Pipe" launcher. The system consisted of several lengths of BT-20 coupled together with a model seated at the top of it all. To operate the system an engine is inserted into the base of the launch tube and is ignited. The motor then shoots up the tube, contacts the model's engine block, and is held firmly in place by means of some bent piano wire. Once the engine pops into the rocket the entire vehicle becomes airborne with, hopefully, a slight increase in performance due to the effect of the closed breech engine launcher. Quite an ingenious device, which allowed Brad to take 4th place with 151 meters/nt-sec.

Another performance-augmenting launcher used at PAR-2 was a massive metal closed breech system built by Barrett Bailey of the Mickey Mouse section (that's *not* a misprint, guys!) of Anaheim, California. The

launcher itself was definitely not a mick, but it failed to win Barrett a place in the Efficiency event.

Hornet B/G was begun in the afternoon and was flown until about 6:00 PM when everyone left the range to clean up, catch a quick meal and attend the evening's Aerospace-Model Rocket Industry Forum.

This year's Forum was held in the handsome City Council Chambers at the West Covina Civic Center. The program began shortly after 8:00 with an interesting and very humorous talk given by Dr. Green of North American Rockwell Corp. This excellent presentation consisted of first-hand stories about our country's early rocketry



Photo by R. Rosanova

The site was a baseball field at Galster Wilderness Park in the hills of West Covina. With one launch rack in left field and a second in right field, one rack was always in operation while the second was loading.

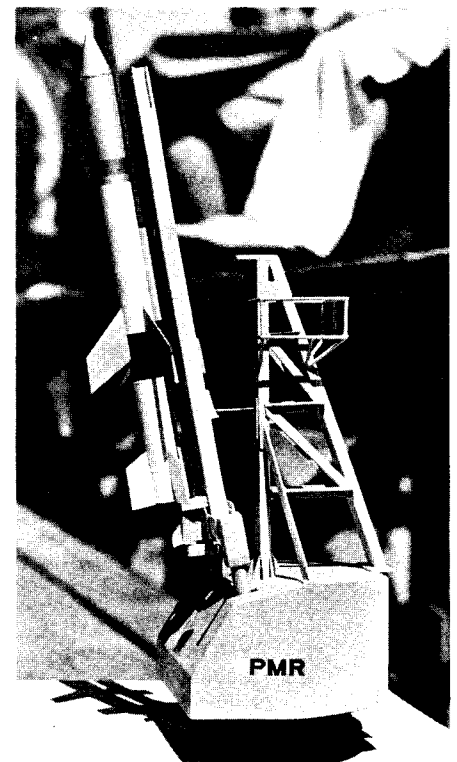

Photo by R. Rosanova

The top Super Scale entry at PAR-II was Terry White's U.S. Navy Super Chief sounding rocket. The prototype, flown late last year from the Pacific Missile Range, uses a Talos first stage and a Sergeant upper stage.

## PAR-2 OFFICIAL RESULTS

### Robin Egg Loft

Div. A	1st	Mike Bissonnette (no other qualified flights)	95.5 m
Div. B	1st	Jim Hadley (Polaris)	261.5 m
	2nd	Clay Smith (Polaris)	168.5 m
	3rd	Bart Hunter (Titan)	139. m
Div. C	1st	Glen Broderick (Arealos)	208. m
	2nd	Steve Lenhard (Titan)	191. m
	3rd	Bruce Reynolds (Titan)	178.5 m
Div. D	1st	Mike Poss (Southland)	137. m
	2nd	James Worthen (S. Seattle) (no other qualified flights)	110. m

### Super Scale

Div. A/B	1st	Bart Hunter (Titan)	ASP
	2nd	Alan Boyer	Astrobee D
	3rd	Marc McReynolds (Arealos)	Little Joe II
Div. C	1st	Bob Willsey (Polaris)	Astrobee 1500
	2nd	Steve Fentress (Southland)	Mercury-Redst.
	3rd	Medina Team (S. Seattle)	ASP
Div. D	1st	Terry White (Polaris)	Superchief
	2nd	James Worthen (S. Seattle)	Nike Smoke
	3rd	Mike Poss (Southland)	Tomahawk No.4

### Class 0 Drag Efficiency

Div. A	1st	Mark Medina (S. Seattle)	137. m
	2nd	Gary Bryant (SCRS) (no other qualified flights)	118.5 m
Div. B	1st	Rick Unland (Southland)	160. m
	2nd	Don Beadle (S. Seattle)	153. m
	3rd	Oscar Woo	126.5 m
Div. C	1st	Bill Plummer (Titan)	196.5 m
	2nd	John Brown	179. m
	3rd	Russ Rasmussen (Titan)	170.5 m
Div. D	1st	Norm Wood (Titan)	203. m
	2nd	John Raum (no other qualified flights)	152. m

### Sparrow Boost/Glide

Div. A	1st	Tim Hopple (Titan)	133.4 sec
	2nd	Jack Voller (Polaris)	15.4 sec
	3rd	Mike Bissonnette	12.4 sec
Div. B	1st	David Reynolds (Titan)	46. sec
	2nd	Mike Bame	44.6 sec
	3rd	Bart Hunter (Titan)	38.5 sec
Div. C	1st	John Brown	103. sec
	2nd	Don Johnson (Polaris)	77. sec
	3rd	Chris Rook (Santa Clara)	56.5 sec
Div. D	1st	John Raum	46.6 sec
	2nd	Terry White (Polaris)	45.6 sec
	3rd	Mike Poss (Southland)	32.4 sec

### Pee Wee Payload

Div. A	1st	Don Labriola (Titan)	159. m
	2nd	Kenneth Adams (No other qualified flights)	97.5 m
Div. B	1st	James Hadley (Polaris)	238. m
	2nd	Larry George	226.5 m
	3rd	Bart Hunter (Titan)	191.3 m
Div. C	1st	Russ Rasmussen (Titan)	190.5 m
	2nd	Marin Popoff (Scat Pack)	177. m
	3rd	Medina Team (S. Seattle)	162. m
Div. D	1st	Mike Poss (Southland)	170.5 m
	2nd	Norm Wood (Titan)	148. m
	3rd	Terry White (Polaris)	147.5 m

### Class 0 Parachute Duration

Div. A	1st	Tim Hopple (Titan)	33. sec
	2nd	Bob Hadley (Polaris)	29. sec
	3rd	John Erickson (Polaris)	23.5 sec
Div. B	1st	Ted Groszewski (Polaris)	216.5 sec
	2nd	Bart Hunter (Titan)	61.5 sec
	3rd	David Reynolds (Titan)	56.1 sec
Div. C	1st	J. Fox (Mickey Mouse)	211.5 sec
	2nd	Scott Newton (Polaris)	74.6 sec
	3rd	Alan Dayton (S. Seattle)	68.6 sec
Div. D	1st	Mike Poss (Southland)	76.4 sec
	2nd	Jess Medina (S. Seattle)	66. sec
	3rd	James Worthen (S. Seattle)	62.8 sec

### Hornet Boost/Glide

Div. A	1st	Tim Hopple (Titan)	51.6 sec
	2nd	Karl Runge	26.6 sec
	3rd	Jack Voller (Polaris)	22.7 sec
Div. B	1st	Bart Hunter (Titan)	69.1 sec
	2nd	David Reynolds (Titan)	68.6 sec
	3rd	James Hadley (Polaris)	57.4 sec
Div. C	1st	Lesnich-Haughty Team (SCRS)	63. sec
	2nd	Brad Beebe (Delta-V)	54.1 sec
	3rd	Russ Rasmussen (Titan)	50.1 sec
Div. D	1st	James Worthen (S. Seattle)	46.5 sec
	2nd	Gary Bell (Southland)	28.7 sec
	3rd	Terry White (Polaris)	20.3 sec.

### Class I Streamer Duration

Div. A	1st	Alan Boyer	24.8 sec
	2nd	Mark Medina (S. Seattle)	22.1 sec
	3rd	Tim Hopple (Titan)	21.3 sec
Div. B	1st	Clay Smith (Polaris)	47.2 sec
	2nd	Rick Unland (Southland)	39.4 sec
	3rd	Joe Laszlo	35.5 sec
Div. C	1st	Brad Beebe (Delta-V)	36.2 sec
	2nd	John Brown	35.3 sec
	3rd	Scott Newton (Polaris)	32.5 sec
Div. D	1st	Terry White (Polaris)	36.8 sec
	2nd	John Raum	30.4 sec
	3rd	Jess Medina (S. Seattle)	29.4 sec

### Scale

Div. A	1st	Bob Hadley (Polaris)	Tomahawk
	2nd	Alan Boyer (no other qualified entries)	Astrobee D
Div. B	1st	Bart Hunter (Titan)	Aerobee 150
	2nd	Clay Smith (Polaris)	Nike Apache
	3rd	David Reynolds (Titan)	ASP
Div. C	1st	Russ Rasmussen (Titan)	Argo D-4 Javelin
	2nd	Bruce Reynolds (Titan)	Astrobee D
	3rd	Rick Grosberg (Southland)	Sandhawk
Div. D	1st	Terry White (Polaris)	Aerobee 170
	2nd	Mike Poss (Southland)	Blue Scout Jr.
	3rd	James Worthen (S. Seattle)	Nike Smoke

### Section Standings

West Covina Titan	1497
Polaris	1236
South Seattle (Washington)	612
Southland	553
Southern California Rocketry Society	132
Delta-V	96
Arealos	72
Şanta Clara	54
Mickey Mouse	30
Scat Pack	18
Los Alamitos	6



Brad Beebe prepares his "blow-pipe" launching system for the Design Efficiency event. The model sits on top of the long tube, and the engine is accelerated through the tube and into the rear of the rocket.

program as well as accounts of recent happenings within the U.S. space program.

Next, Mr. Earl Cooper of the Missile Systems Division of Atlantic Research Corp. talked for a few moments and then treated us to a beautiful 15-minute film on the ARC Athena rocket system. Scale bugs in the audience were reported to have been drooling during this flick.

After a short break, presentation of awards for the day's events took place. Following this, Dane Boles of Estes Industries, Larry Brown from Centuri Engineering, Bob Lercari from Lercari Engineering, and Doug Malewicki of L.M. Cox spoke about their firm's new products which were on display at the launch site that day. New items of special interest were the Estes scale Bomarc missile and the Transroc telemetry system, the Lercari Remote Control Launcher, and the Cox Rocketry Science Set.

PAR-2 resumed early Sunday morning with the Payload flights. Following this event, Scale and Super Scale models were flown for judges Bob Schindler, Bob Crockett, Larry Copeland, Dave Nichols and Pacific Division Manager Lee McMahon. Scale model quality this year was really outstanding and



PAR-II's only female contestant, Ellen Haven, preps her Hornet B/G entry. The models in this event were quite varied with kits, such as Ellen's Falcon, and home designs.

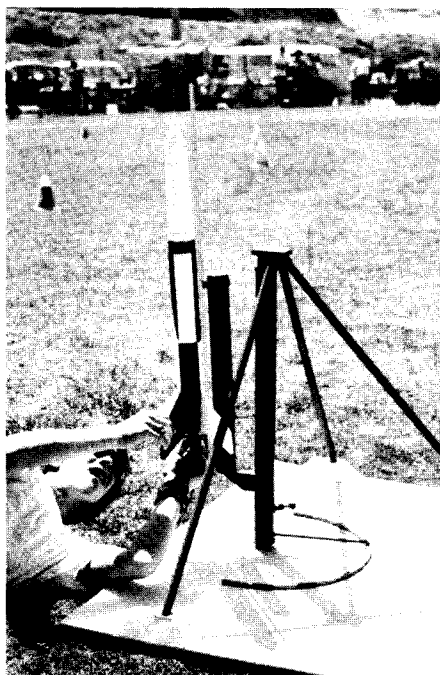

Bob Willsey's beautiful model of the Astrobbee 1500 and its launcher took first place in C Division Super Scale.

as a result, competition in the scale events was especially keen. After the scalers came Sparrow B/G in which most contestants flew their Hornet class gliders.

Class 0 Parachute Duration and Class 1 Streamer Duration followed Sparrow and these two events were flown simultaneously. Even with 1/2A engines, many PD birds were last seen drifting east and out of the launch site. When you're trying to chase a parachute out of this bowl-valley site you quickly realize why some rocketeers call it "the pit." It is only with great difficulty that you get your model back.

The range closed and competition ended as the sun was about to set, and final event awards were given out after about a half



A huge model of the Jupiter-C which launched Explorer I made a crowd-pleasing flight during Sunday's demo launchings.

an hour's worth of stall-talk over the P.A. system by WCTS Assistant Advisor Steve Lenhard while the judges finalized results of the day. Individual awards were presented, and due to the lack of time at the meet itself it was later announced that once again the West Covina Titan Section had won the Section trophy.

With the meet over, we all packed up and headed for home. This meant a fun 20 hour drive for the contestants from Washington. Next year, however, we Southern Californians will get to enjoy the drive as tentative plans for PAR-3 call for the meet to be hosted by the South Seattle Rocketry Society in Seattle, Washington during mid-June, 1972.

## CENTURI DISPLAYS AT PAR-II

Centuri Engineering Co. was represented by Lawrence W. Brown and Richard Rosanova at the recent Pacific Area Regional meet at West Covina, California.

Among the many flight demonstrations, Larry Brown launched the Mach-10, Saturn V, and MX-774 model while Dick Rosanova took photos. In an "R&D" demonstration a Centurion was flown against a Big Bertha. The object was to see how close a tandem arrangement of two C6 engines would come to a single large "D" engine. The answer: quite close - 940 feet for the two C engines, 980 feet for the D engine.

The Saturn V model, loaned by a friendly contestant, was flown with a 4 engine system and featured a set of clear plastic fins - soon to be included in all Centuri Saturn V kits and also offered as a "custom" item.

Leroy Piester, president of Centuri, was able to attend briefly. He chatted with contestants and watched as his team sent a big Aero Dart howling out of sight into the Los Angeles haze.

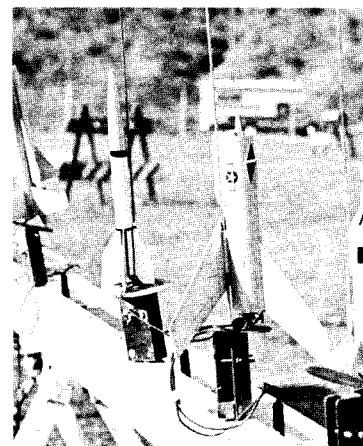

Centuri's "Mach-10" boost/glider and semi-scale MX-774 on the demo pad at PAR-II.

# Reader Design Page

This month's Reader Design, the Mosquito, is a two-stage sport model designed by Peter Hardt of Phoenix, Arizona. Standing only 4.5" tall, this model is one of the world's smallest two-stage rockets. It should be flown with a 1/2A6-0 in the booster and a 1/2A6-2 in the upper stage. Since the model is so light and has a large fin area, tumble recovery is used on both stages. Even with a 1/2A in each stage, the Mosquito will fly to over 500 feet.

## Parts List

BNC-20A	Nose Cone
BT-20J	Body Tubes
EB-20A	Thrust Ring
BFS-10	Fin Stock
LL-2A	Launch Lug

(All Parts Available from Estes)

Each month **Model Rocketry** will award a \$5.00 prize for the best original rocket design submitted by a reader during the preceding month. To be eligible for this prize, entries should be carefully drawn in black ink on a single sheet of 8 1/2 by 11 paper. Sufficient information should be contained in the drawing so that the rocket can be constructed without any additional information.

Submit entries to:  
 Rocket Design  
 Model Rocketry  
 Box 214  
 Boston, Mass . 02123

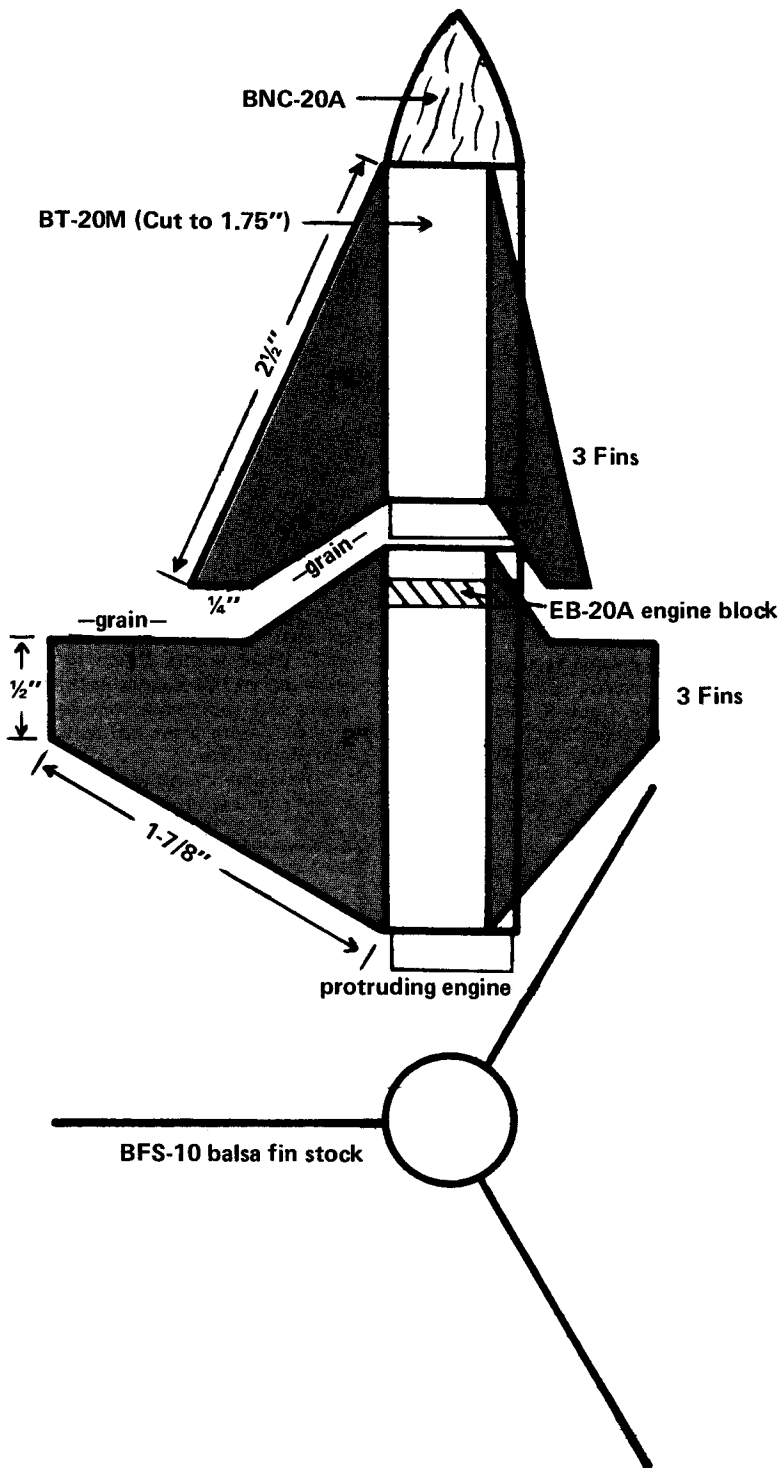



# CLUB CORNER



by Bob Mullane NAR 4157

## PLANNING A MEET

Whenever two or more rocketeers get together, a dispute over who's rocket is best almost always develops. The only way to answer that question is in a controlled contest. At a meet, everyone flies under the same rules and a panel of judges determines the winners. To be fair to all contestants, the meet must be well planned and executed. This month I'll cover the *planning* of a meet and next month I'll discuss the actual *running* of the meet.

A Contest Director (CD) must be appointed as soon as planning is begun. The CD will be in control of the entire meet and will be responsible for its success (or failure). While the CD will have many other club members to help him, *he is the final authority in all matters concerning the meet* and must direct (and check on) the work being done by the members of his contest committee. So, use care in selecting the CD to be sure he (she) will be able to handle the job.

Often, the contest director will appoint other people to oversee certain key tasks. If the club doesn't have a publicity officer, the CD may appoint a person to handle publicity for the meet. If the club does have a publicity officer, he will do this job. (For more details see the June '71 *Club Corner*.) If the club doesn't have a range operations committee, the CD may wish to appoint one for the meet. (This will relieve him of the problems and the many small details of running the range.) Other Assistant Contest Directors may be appointed to cover such areas as obtaining prizes, selling refreshments, handling the paperwork, etc. Of course, the appointment of these people does not relieve the CD of the responsibility to make sure these jobs are completed. Regular meetings of the contest committee should be held so everyone will know how planning is progressing and to prevent duplication of effort. (Much time and work can be wasted if several people are performing the same job without any knowledge of the others.)

The committee should decide, well in advance, which events will be held. If the meet will be NAR sanctioned, NAR events must be chosen and flown under the NAR's rules. If the meet is not NAR sanctioned, you can make up your own rules and judging methods. (If you do make up your own rules, you must make sure that everyone who will compete knows and understands them well before the meet.) Some possible events are:

**Duration** — In this event, all models must

use a certain recovery system (parachute, streamer, B/G, etc.) and engine class. A possible event might be "B Engine Parachute Duration." The model is timed from the first motion on the pad to the moment it lands, or is stopped by a tree, wire, fence, roof, etc. The model getting the longest time is the winner. (In the case of a B/G the glider, not the pod, is timed.) Stopwatches are the only instruments needed to judge this event.

**Altitude** — In this event, all models must use a predetermined total impulse (which can be obtained in any way the contestant desires: one engine, staging, cluster, etc.) and the models are tracked for altitude. The rocket going the highest wins. Tracking scopes, a data reduction staff, and a communication system are needed for this event, so a new club which doesn't have this equipment may want to avoid any tracking events at first.

**Payload** — This is similar to altitude except the rocket must carry a certain payload. (A raw egg, a weight of prescribed size and weight, a whistle, 10¢ in pennies, etc.) The payload must remain in the rocket and be undamaged (especially in the case of the egg).

**Spot Landing** — Coming as close as possible to a target on the ground is the object here. An engine class and type of recovery system are specified. To prevent the "Kamikaze approach," a certain minimum altitude (say about 50 feet) should be set for *full* deployment of the recovery system. A long tape measure is all that's needed to judge spot landing.

**Scale** — Here, the contestant must build a miniature replica of an actual rocket. The contestant must supply information showing the dimensions and details of the prototype (many such plans have appeared in *MRM* or are available to NAR members from *NARTS*). The models are judged for workmanship, adherence to scale, degree of difficulty, and flight. A requirement might be set that the model fly stably and return undamaged and the flight not be judged. To simplify the judging of scale, you might want to require everyone to build the same model. If so, everyone must be given plenty of time to build the model (you should supply everyone with plans in this case or all agree to use a certain plan which everyone has). To judge scale, you need rulers, calipers, and lots of time. To make the event more interesting, you might want to require a model of both the rocket and its launcher to be built.

**Research and Development** — This can best

be described as a science fair devoted to model rocketry experiments, developments of new techniques, scientific studies using rockets, etc. This is a difficult event to judge; I would suggest consulting a good book (there are many in your local library) about science fairs for ideas about how to run and judge R&D. Many of the items we use constantly now were once only R&D projects, for example: Boost Gliders, rocket borne cameras, CP Calculation (Barrowman type), telemetry transmitters, many computer programs, use of styrofoam parts, and many more. What can you add to our scientific hobby? R&D may give you a chance to develop a revolutionary innovation. **Craftsmanship** — This event requires no instruments to judge, but might be the hardest of all. The rocket built with the most skill wins. The judging is based on smoothness of finish, care in construction, strength, attractiveness and beauty, uniformity of shaping of fins, in other words *craftsmanship*. All models must fly safely and stably to qualify. This event may be combined with another, for example: "Best Craftsmanship in Parachute Duration." If this is done, everyone must know well before the meet which event will be judged for craftsmanship. **Funny Events** — Use your imagination on this one! Some which have been tried: Non-Rocket (the object which looks least like a rocket, but still flies properly), Plastic Rocket (anything plastic which you can get to fly), ping-pong spot landing (eject a ping-pong ball from your model on a streamer and try to land it as close to a target as possible). Make up your own events, but distribute the rules to all contestants well in advance of the contest.

These are a few of the events which are being flown at meets, many more are possible. Once you've selected the events and rules, the contest committee should get approval from the club membership. (There is no point in scheduling an event only one or two people will enter.)

If your club is very small, elaborate plans and awards may not be necessary. If you have many members, perhaps you can get a local store, club, hobby shop, or organization to sponsor your meet and provide prizes. Prizes can be trophies, ribbons, certificates, or merchandise. (Many hobby shops will donate kits for prizes.) If no sponsor is available, the members might agree to each pay a set entry fee to pay for prizes, or to do without prizes.

If you are not running an NAR sanctioned meet, you should give some thought to the paperwork for the meet. You'll need to record the data from each flight. A series of index cards could be used, one for each entry in each event. If cards are used, each card should contain the name of the contestant, the name of the event, and the flight data from that event (duration time, azimuth and elevation from tracking scopes, etc.). The cards can then be placed in order of highest to lowest performance, the winner being the first card. Another way to keep the records would be on a sheet of paper for each event. On each sheet, the entrants in that event are listed and their performance filled in after their name. Any system that allows all the needed data to be recorded and credited to the right person is acceptable. Try to

(Continued on page 46)

# THE MODEL ROCKETEER



NATIONAL ASSOCIATION OF ROCKETRY, Box 178, McLean, Virginia 22101

*The Model Rocketeer* is published monthly in **Model Rocketry** magazine by the National Association of Rocketry, Box 178, McLean, Virginia 22101. The National Association of Rocketry, a non-profit educational and charitable organization, is the nationally recognized association for model rocketry in the United States. **Model Rocketry** magazine is sent to all NAR members as part of their membership privileges. NAR officers and trustees may be written in care of NAR Headquarters. All material intended for publication in *The Model Rocketeer* may be sent directly to the editor.

## Officers of the Association

James Barrowman  
Bryant Thompson  
Jay Apt  
John Worth  
Robert Atwood  
Lindsay Audin  
Carl Kratzer  
G. Harry Stine  
Gerald Gregorek  
Ellsworth Beetch  
Howard Galloway  
Alfred Lindgren  
Forrest McDowell  
Richard Sipes  
William Roe  
Leslie Butterworth

President  
Vice President  
Secretary  
Treasurer  
Section Activities  
Publications Comm.  
Public Relations  
Liason Committee  
Standards & Testing  
Trustee  
Trustee  
Trustee  
Trustee  
Trustee  
Honorary Trustee  
Honorary Trustee

The Model Rocketeer  
Carl Kratzer, Editor  
320 Thurston Ave.  
Ithaca, NY 14850

Technical Services  
Slot & Wing Hobbies  
511 South Century  
Rantoul, Ill. 61866

NAR Contest Board  
Richard Sipes  
5012 60th St.  
Hyattsville, MD

Leader Admin. Coun.  
Elaine Sadowski, Sec.  
1824 Wharton St.  
Pittsburgh, PA 15203

Northeast Div. Mgr.  
Tag Powell  
714 Raritan Ave.  
Highland Pk, NJ

Southland Div. Mgr.  
Richard Toner  
5012 Valley Stream  
Charlotte, NC 28209

Mid-Amer. Div. Mgr.  
Manning Butterworth  
Rm 315, 5540 Hyde Pk  
Chicago, Ill. 60637

Pacific Div. Mgr.  
Lee MacMahon  
13629 Ardis St.  
Bellevue, CA

Mountain, Div. Mgr.  
Mel Severe  
8361 Chase Way  
Arvada, Col. 80002

Southwest Div. Mgr.  
Forrest McDowell  
10058 Larston Street  
Houston, TX 77055

## Film List and NAR Films — Mark Barkasy

*Mark is a native of Wallingford, Connecticut. He attends the University of Alabama, where he is trying for a B.S. degree in Aerospace Engineering. He is a former member of the late Cheshire Section in Connecticut.*

I am presently working on two projects. One is the compiling of a list of films and publications of interest to sections or individual members. These will be available from government agencies, companies, individual members, sections, and film distributors.

The other project is closely related. It is the establishment of permanent NAR publicity films (16 mm and 8 mm) and slides. These will be made available to NAR sections and possibly to individual members. The main purpose of this is to help sections to attract more new members.

## Questionnaire Analysis and Section Manual — Wanda Boggs

*Wanda lives in Gladstone, Oregon. She is a member of the Tri-City Cosmo-tarians. She has completed her freshman year at Clackamas Community College, where she is majoring in foreign languages, primarily French and German. Her interest in model rocketry began about two years ago when she noticed her younger brothers "making strange-looking airplanes." In addition to rocketry, her hobbies include sewing and reading.*

My projects this year include evaluating the NAR questionnaires sent out in the renewal packets and preparing a new edition of the **Section Manual**, hopefully in time to have it published by NARAM 13. The work on the questionnaires includes tabulating all responses and comments on each questionnaire returned—all 1396 of them. I try to give equal attention to all criticisms and take particular note of those comments which seem to be prevalent.

The **Section Manual** (one of the oldest of LAC projects) is a guide for new, as well as older sections. There are presently five chapters—section newsletters, model rocket lectures, displays, and demonstrations, publicity for local model rocket clubs, range equipment, and running contests. A chapter on rocket photography is in preparation this year. Chapters still requiring revision are going out to selected individuals and clubs for comments and feedback.

# 1970-1971 LAC Reports

The following are brief summaries of the LAC projects that have been carried out by the outgoing LAC. We hope that presenting them will make the reader more aware of the activities of the LAC, and also that it will serve to introduce the LAC members as people (perhaps something we should have thought of sooner).

## LAC Elections – Bob Mullane

*Bob is completing his third year as an LAC member. He attends Saint Peter's College, and lives in Harrison, New Jersey. At NARAM 10 he was Leader National Champion. He has been president of the Pascack Valley NAR Section and editor of that section's newsletter, Impulse. Bob is an avid photographer, and he can often be seen wandering around the rocket range photographing everything in sight. After serving as LAC Chairman for the past year, Bob is preparing to turn twenty-one and retire.*

The LAC ballot appearing in the *Model Rocketeer* was my major project. This is the first time that an LAC election has been open to all eligible members. Until last year, only those members present at NARAM could run or vote for the LAC. Last year, an attempt was made to run the election by mail, but this was prevented by a lack of response to the call for resumes and a little Post Office strike (I think that's the official excuse.) Anyway, this year a much better response was seen (although over 75% of the resumes came within two days of the deadline, causing more than a little anxiety) and the balloting was open to all Leader and Senior members of the NAR. Since the LAC will have been elected before NARAM, the new LAC will be able to meet at NARAM and get started on next year's projects faster than previous LACs have. It is also hoped that the NARAM meeting will provide a smoother transition from the 1970-1971 LAC to the 1971-1972 LAC. By using the *Model Rocketeer* to distribute the ballot, we not only reach all voting members but also can run the election at no cost to the NAR.

I am also working on re-writing many of the technical reports available from NARTS and on Mark Barkasy's slides.

## Organizing New Sections – Richard Malecki

*Rich is an Aerospace Engineering major at Georgia Tech. He is from Brooklyn, and has been secretary and news-letter editor of the Xaverian Rocketry Club.*

With the cooperation of the rocketeers in Atlanta and Regional advisor, Mr. Toner, I am presently trying to get more model rocketry organization in the Atlanta, Georgia area. I also direct inquiring rocketeers from all over the nation to their Regional Managers for assistance in forming model rocket clubs. I am especially concerned with those people who have no one to write to for help and advice on this matter.

## Regionalizing Competition – Arnold Pittler

*Arnie has just completed his junior year at Carnegie-Mellon University, where he is an Electrical Engineering major. He is the president of Beta Sigma Rho fraternity, a member of the Student Advisory Committee of the Electrical Engineering department, and a member of several honorary organizations. In the little spare time that he has, he works on a project designed to encourage high school students to investigate the advantages and disadvantages of engineering and science careers. Arnie lives in Pittsburgh.*

My project on the LAC involves looking at the practicality, advantages, and disadvantages of regionalizing the NAR for the purpose of competition. [Editors note: *The regions discussed in this article are not those that are now in existence for the purpose of Section Activities personnel, and they should not be confused with the NAR's six regions.*] The project currently is aimed at instituting a system of regional qualifying meets for the national meet, with competition points to be cumulative only over these regional and national meets. The project involves determining if non-section members would be aided or hindered in the attempt for national awards, while at the same time de-

termining if such a system would encourage people who were not close to any sections and who probably would be unable to join a section immediately to join the NAR. Similar questions must be answered for section members, in addition to the question of how the new system would affect current membership.

The practicality of defining regions of approximately equal size, ease and cost of transportation to points within the regions, and the ability of that region to support a contest are now being analyzed. This phase of the project involves mapping each NAR member's location and then deciding on regions based on the criteria above. Once the practicality of such a system is determined, the benefits and drawbacks to fair competition, non-section members, section members, and the NAR can be evaluated. Until such a scheme for regions is devised, however, it is impractical to begin assessing the net worth of the scheme. By early summer some proposed regions will be available for NAR members to comment on.

## LAC Scale Pak – Charles Russell

*Chas lives in Hilliard, Ohio. He has completed his sophomore year in Aeronautical Engineering at Ohio State. Besides rocketry, Chas is interested in "astronomy, girls, OSU football, sports, girls, space, etc." He is also the Head Buzzard of the Royal Order of Buzzards.*

As my LAC project I am working on the development of scale paks to be sold through NAR Technical Services. The idea behind the project is to provide to NAR members accurate scale plans and data for use in NAR scale competition. The renewal packet questionnaires show that there is an interest in good scale data. It is the hope of LAC members that the availability of such plans would stimulate the growth of scale competition among the younger members of the NAR. With a photo (to be made available by Rocket Equipment Co.), the LAC scale pak will qualify as minimum scale data.

With the help of Doug Ball, drawings of the I.Q.S.Y. Tomahawk (Round 3) are being completed. The written data is being drafted and confirmed at this time.

## LAC Newsletter Award – Elaine Sadowski

*Elaine is serving her fourth, and last, year on the LAC. She has been both Chairman and Secretary of the group. Elaine is a native of Pittsburgh, Pa. and she enjoys making*



*photo by Greg Murphy*  
Junior members Craig Streett (left) and Mark Anderson (middle) of the Columbus Society for the Advancement of Rocketry help LAC member Chas Russell take dimensions from half-scale blueprints of the I.Q.S.Y. Tomahawk, subject of the first LAC Scale Pak. Not pictured is Leader Member Doug Ball of the Mansfield Aeronautics and Space Association who is in charge of drafting the Pak drawings.

rockets, painting, reading, and playing her recorder. She received a B.S. degree in Mechanical Engineering from Carnegie-Mellon University in May.

This year it was felt that the LAC Newsletter Award needed revision. In order to determine what changes and clarifications should be made, letters were sent out to all editors who had participated in the contest in 1970, to the two winning editors (these asked for lists of things that the winning editors tried to put into their newsletters), and to all judges. Replies were received from Mrs. Alice Englund, advisor to *Emanon*, all of the judges (Manning Butterworth, William Simon, Mrs. Eva LaCroix, Leroy Piester, and Mrs. Frances Guernsey), and Andy Elliott, editor of the first winning newsletter, *ZOG 43*. On the basis of these replies, suggestions from other people, and my experience from running the contest for two years, I drew up new, more detailed criteria for judging the newsletters, as well as criteria for selection of the judges and the LAC member who runs the contest. The criteria are not meant to be a "cookbook" for editors, but merely categorizations to enable the judges to compare newsletters more easily. A new feature added this year is the power given to the judges to award special honorable mentions for outstanding achievements, the specific categories to be determined by the judges.

### PROPOSED AMMENDMENT TO THE NAR BY-LAWS

by G. Harry Stine

I hereby propose that the NAR By-Laws be amended as follows:

CHANGE Article III, Section 1 to read:

**Section 1:** The membership of the Association will be comprised of citizens of the United States of America and of organized groups of U.S. citizens, and citizens of other nations that do not yet possess an organized model rocket club affiliated with the respective FAI-member national aero club.

**Rationale:** The growth of model rocketry on an international scale requires the direct participation of the NAR as the world's leading model rocket organization. Since 1962 when the FAI adopted model rocketry as an official aerospace sport, the NAR has not been accepting memberships from foreign nationals. The situation now in 1971 is that there are a number of nations with no national aero clubs or nations in which the national aero club has rejected or ignored the model rocketeers. To promote communications and the development of strong nuclei of model rocketeers in other nations that do not already have organized model rocket clubs in their NACs, the NAR needs to open its ranks, take in these "orphans," build their strength, and thus eventually bring their strength and influence to the point where their NAC will accept them as part of the aerospace sporting complex. Note that the By-Laws still permit the Board of Trustees to establish whatever dues are necessary, and also permit the Board to establish policy regarding whether or not the NAR insurance coverage would pertain to these foreign NAR members operating outside the United States. Note also that the wording of the Ammendment would not permit NAR membership to be granted to citizens of, say, Canada or Belgium where there are already strong model rocket organizations. But it would permit us to do something about people from India or Argentina where there is no model rocket club affiliated with the FAI-member NAC---yet. It would also promote model rocket safety in these countries too.

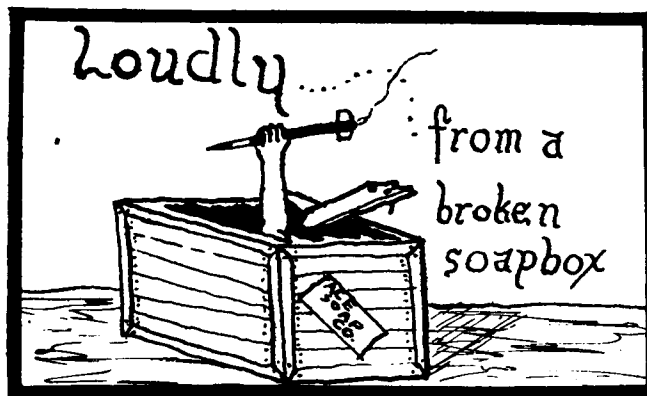

As a new *Pink Book* is worked out for use in the near future, I think it's important to consider a few fundamental ideas that have been ignored lately.

Ever since its beginning, model rocketry has been oriented toward research and developmental work; it has been a "technology in miniature," as Stine called it. The enjoyment in model rocketry comes chiefly from constantly reworking and developing designs and ideas, rather than flying one rocket over and over again. Now, such R&D work may be divided into two areas which I will call "internal" and "external" research. Internal research is research concerning the rocket itself, as well as the airflow around it and its flight path. External research involves the use of model rockets as instruments for the study of their environment. At this time I think it is reasonable to say that there is little external research with model rockets that cannot be done better with kites, balloons, etc. (with a few exceptions, such as instrumented rockets shot into thunderstorms or treetops).

So, advancing study of model rocketry involves the rocket as a system which is interesting in itself, just as mathematics interested the old geometers because of its structure, and not because of any practical applications. Having come this far, we can see that the distinction between "sport" and "serious" model rocketry has largely disappeared, and the classification of modrocks as "normal" or "odd" has become totally meaningless. Model rocketry is, for the most part, amateur engineering.

Then what is model-rocket competition? It must be defined as organized motivation toward the solution of selected engineering problems.

The connection of all this with the new *Pink Book* is this: I think most rocketeers are bored by the standard competition events (low-powered parachute duration, design efficiency, etc.). I think that the only events left which hold any interest for me (except the high-powered versions of the old standards, which most clubs cannot fly due to money and space restrictions) are the scale events, plus eggloft, quadrathon, and a few other little-flown "odd" events. The rest have degenerated into a contest for second-guessing judges and trackers, simply because *their engineering problems have been solved*. To regain interest it is necessary to introduce new, unsolved engineering problems (whether to retain or throw out the old events is a side issue).

Well, then what kinds of new problems can we introduce? Here are a few of my suggestions:

Increase the allotment of scale points to flight characteristics to 200. This would motivate people to simulate the prototype's flight behavior; for instance: spin and de-spin programs, staging, Little Joe aborts, etc. No simulated explosions or crashes, of course.

Add a new event for rockets carrying 1 oz. of water rather than lead. Require contestants to pour out, say,

90% or 95% by volume, after flight.

Devise an event for duration of rockets with helicopter or autogyro recovery.

Two-stage finless streamer Duration event. Open to two-stage birds with streamer in top stage; time the duration from liftoff to top-stage touchdown. Second stage must have no fins or tail stabilizing cones.

Get the idea? Remember, the distinction between "odd" and "normal" has no meaning. The main consideration must be to make judging of new events as simple as possible.

I would like to welcome any comments on any of this, and I hope even more to see some action taken somewhere.

Stephen S. Fentress  
NAR 4495 Lr, Southland Section

## Record Filing Procedure

Howard Galloway, chairman of the Records Subcommittee, has given us the following information in regard to record attempt procedure:

Within 3 days of a U.S. or FAI record attempt, the modeler must notify the NAR Records subcommittee. Follow up material (described below) should be postmarked no later than 60 days following a record attempt. (Howard suggests that you send in material sooner to allow time for the committee to check your material and request corrections or additions before the time limit is up.)

You should send:

for FAI records—6 identical copies of photos, plans, and record attempt documents.

for U.S. records only—3 identical copies of photos, plans, and record attempt documents.

The photos should be 5" by 7" enlargements. The image of the model should be as large as possible consistent with the 5 x 7 format. In order for the dimensions to be checked from the photograph, it is necessary for you to take the picture under the following conditions:

- 1.) The measuring device (scale) and the longitudinal axis of the model should:
  - a) be parallel to each other;
  - b) be no more than one inch apart (if the body of the model is too large to allow this, then put the scale as close to the model as possible;
  - c) lie in a plane which is parallel to the plane of the film;
- 2.) Center the film over the center of the model while photo is being taken.

The plans should include all measurements, gross weight, and no-engine weight. (see *Pink Book*, section 32.)

Before you send the homologation information, make the following test:

- 1) Could someone correctly construct a model like you flew using the dimensions on the plans that you have submitted? Note: The drawings and dimensions shown must agree!
- 2) Do the scaled dimensions taken from the photo agree with the dimensions shown in the plans?

If the answer to either of the above questions is no, then correct your information before sending it.

If you have any questions, call Howard Galloway at (301) 987-4395, or write to him at 428 Ben Oaks Drive, Severna Park, Maryland 21146.

## Record Filings

The following is a list of people who have filed for records. The times and altitudes are not given since these are only record *filings*. The people listed here do not necessarily hold records.

### Hornet Boost/Glide

Division A

Edward Bachman, NAR 18431, 25 April 1971, Place: Lehigh University, Bethlehem, Pa.

J. Tam Joines, NAR 17998, 16 May 1971, Place: IGMR, Pa.

Dave Peretz, NAR 18254, 25 April 1971, Place: Tamiami Regional Park, Miami, Fl.

Division B

Dave Shucavage, NAR 16208, 25 April 1971, Place: Lehigh Univ., Bethlehem, Pa.

### Swift Boost/Glide

Division A

David Peretz, NAR 18254, 25 April 1971, Place: Tamiami Regional Park, Miami, Fl.

Don Sternglass, NAR 13482, 25 April 1971, Place: Lehigh Univ., Bethlehem, Pa.

Division B

Dave Shucavage, NAR 16208, 25 April 1971, Place: Lehigh Univ., Bethlehem, Pa.

Division D

John A. Arthur, NAR 18563, 25 April 1971, Place: Tamiami Regional Park, Miami, Fl.

### Sparrow Boost/Glide

Division A

Dave Peretz, NAR 18254, 25 April 1971, Place: Tamiami Regional Park, Miami, Fl.

Division C

Richard Brandon, NAR 14228, 29 April 1971, Place: Lehigh Univ., Bethlehem, Pa.

James Pommert, NAR 16908, 18 April 1971, Place: Boeing Kent Space Center, Kent, Washington. (also FAI)

Division D

Jon Robbins, NAR 16092, 18 April 1971, Place: Columbus, Ohio.

### Hawk Boost/Glide

Division A

Ronald Brady, NAR Pend., 24 April 1971, Place: Tamiami Regional Park, Miami, Fl.

Dan Sternglass, NAR 13482, 25 April 1971, Place: Lehigh Univ., Bethlehem, Pa.

Division B

Dave Shucavage, NAR 16208, 24 April 1971, Place: Lehigh Univ., Bethlehem, Pa.

### Eagle Boost/Glide

Division B

Steve Peretz, NAR 18254, 25 April 1971, Place: Tamiami Regional Park, Miami, Fl.

Division D

Tom Wullette, NAR 14696, 9 May 1971, Place: Pittsburgh, Pa.

### Condor Boost/Glide

Division C

Alan Robert Dayton, NAR 17367, 18 April 1971, Place: Kent Washington. (Also FAI)

Division D

John Norcross, NAR 17798, 25 April 1971, Place: Tamiami Regional Park, Miami, Fl.

### Class 0 Parachute Duration

#### Division B

Keith Mengel, NAR Pend., 18 April 1971, Place: Columbus, Ohio.

John Omachel, NAR 17089, 13 March 1971, Place: Goddard Antenna Range, Greenbelt, Md.

### Class 1 Parachute Duration

#### Division A

Tam Joines, NAR 17998, 17 April 1971, Place: Camp A.P. Hill, Va.

#### Division C

Michael Burzynski/Tim Fornshill, NAR 17871/18286, T067, 17 April 1971, Place: Camp A.P. Hill, Va.

Paul Shelton, NAR 16602, 2 May 1971, Place: Ft. Meade, Md. (also FAI)

### Robin Egg Loft

#### Division D

Jon Randolph, NAR 15496, 17 April 1971, Place: Columbus, Ohio. (also FAI)

### Pigeon Egg Loft

#### Division C

Alan Dayton, NAR 17367, 28 Feb., 1971, Place: Kent, Wash.

### Design Efficiency

#### Division A

\*John M. Kennedy, NAR 18562, 25 April 1971, Place: New Canaan, Ct.

#### Division C

William Chilcoat, NAR 13485, 3 April 1971, Place: Goddard Spaceflight Center, Greenbelt, Md.

\*Connie and Eleanor Stine, NAR 1300/1955, 25 April 1971, Place: New Canaan, Ct.

### Class 0 Altitude

#### Division A

\*John M. Kennedy, NAR 18562, 25 April 1971, Place: New Canaan, Ct.

#### Division C

\*Connie and Eleanor Stine, NAR 1300/1955, 25 April 1971, Place: New Canaan, Ct.

### Class 0 Scale Altitude

#### Division B

\*Michael Scarborough, NAR 18524, 25 April 1971, Place: New Canaan, Ct.

#### Division C

\*Connie and Eleanor Stine, NAR 1300/1955, 25 April 1971, Place: New Canaan, Ct.

#### Division D

\*Alice and Laura Englund, NAR T022, 25 April 1971, Place: New Canaan, Ct.

### Hornet Rocket Glider

#### Division D

Jon Robbins, NAR 16092, 15 May 1971, Place: IGMR, Pa.

### Sparrow Rocket Glide

#### Division D

Jon Robbins, NAR 16092, 18 April 1971, Place: Columbus, Ohio.

### Condor Rocket Glide

#### Division D

Jon Robbins, NAR 16092, 15 May 1971, Place: IGMR, Pa.

(\* indicates that the record attempt was declared void)

## Which Events?

The Contest Board inventoried the first one hundred contests sanctioned this year to discover the frequency NAR's range of events were being held. Here are the board's findings:

Event	Times Sanctioned	Event	Times Sanctioned
R&D	0	Cl. 0 Scale Alt.	0
Space Systems	1	Cl. 1 Scale Alt.	2
Super Scale	8	Cl. 2 Scale Alt.	1
Quadrathon	9	Cl. 3 Scale Alt.	0
Scale	29	Cl. 4 Scale Alt.	0
Hornet B/G	34	Hornet R/G	4
Sparrow B/G	43	Sparrow R/G	8
Swift B/G	18	Swift R/G	6
Hawk B/G	18	Hawk R/G	4
Eagle B/G	10	Eagle R/G	1
Condor B/G	8	Condor R/G	1
Robin Eggloft	26	Design Efficiency	21
Pigeon Eggloft	15	Cl. 0 Drag Effic.	11
Ostrich Eggloft	6	Cl. 1 Drag Effic.	5
Roc Eggloft	4	Cl. 2 Drag Effic.	0
Pee Wee Payload	12	Predicted Alt.	5
Single Payload	7	Plastic Model	11
Dual Payload	2	Drag Race	11
Open Payload	2	Parachute Spot Land.	10
Streamer Spot Land.	10	Open Spot Landing	34
Cl. 0 Parachute Dur.	28	Cl. 0 Streamer Dur.	9
Cl. 1 Parachute Dur.	35	Cl. 1 Streamer Dur.	28
Cl. 2 Parachute Dur.	11	Cl. 2 Streamer Dur.	17
Cl. 3 Parachute Dur.	3	Cl. 3 Streamer Dur.	9
Cl. 00 Alt.	4	Cl. 0 Alt.	4
Cl. 1 Alt.	6	Cl. 2 Alt.	2
Cl. 3 Alt.	2	Cl. 4 Alt.	0

## NAR Gets 100 Dollars!

The NARHAMS section in Maryland made a profit on a recently held regional meet. The members of that section voted to contribute \$100 of the profits to the NAR. Paul Conner, NARHAMS president, said in a letter to NAR Treasurer John Worth, "Without the National Association there wouldn't have been a contest." Hats off to the NARHAMS!

## NART-2 Held In Harrisburg

On May 14-16 NAR's Capitol Area Section (NARCAS) held its second annual record trials with Condor B/G, R/G, and night streamer duration as the main attractions.

NARCAS listed 109 participants on hand at Indiantown Gap Military Reservation in Harrisburg, Pa. as the fun began Friday night. Contestants made a gallant attempt with Blinkin Beacons and glow in the dark rockets, but seemed satisfied to leave the dark and the cold for the barracks after 15 or so flights.

Saturday dawned, modelers were up early for army-provided chow and then headed out to the range. The weather cooperated this year—at least on Saturday—and the meet ran at a leisurely pace while Class III PD, Hornet R/G, and Condor B/G were flown. The range closed at 5:00 with nerves intact and the gang moved to Marquette Lake for a picnic style dinner, Hawk worshipping, and frisbee tumbling.

## CURRENT ENGINE CERTIFICATION LIST

Dr. Gerald Gregorek, chairman of the NAR's Standards and Testing Committee, has provided the following list of certified rocket engines.

The engines listed below have been granted NAR Contest Certification effective May 1, 1971, except as noted:

### Centuri Engineering Company

½A6-0	½A6-0S	½A6-2	½A6-2S	½A6-4	½A6-4S
A5-2	A5-4	A8-0	A8-3	A8-5	
B4-2	B4-4	B4-6	B6-0	B6-4	B6-6
B14-0	B14-5	B14-6	B14-7		
C6-0	C6-5	C6-7			

### Minimax Series

E15-4	E15-6	E15-8	E62-0	E62-4	E62-7
F16-4	F16-7				

### Enerjet Series

E24-4	E24-7	E24-10
F52-5	F52-8	F52-12
F67-6	F67-9	F67-14

### L.M. Cox Manufacturing Company

A6-0	A6-2	A6-4	A6-5		
B4-0	B4-3	B4-5	B4-6	B6-0	B6-6
C6-0	C6-2*	C6-4	C6-6	C6-7	
D8-0	D8-3				

### Estes Industries, Inc.

¼A3-1	¼A3-1S	¼A3-2	¼A3-2S	¼A3-4	¼A3-4S
½A6-0	½A6-0S	½A6-2	½A6-2S	½A6-4	½A6-4S
A5-2	A5-2S	A5-4	A5-4S	A8-0	A8-3 A8-5
B4-2	B4-4	B4-6	B6-0	B6-4	B6-6
B14-0	B14-5	B14-6	B14-7		
C6-0	C6-3	C6-5	C6-7		
D13-0	D13-3	D13-5	D13-7		

Sunday bloomed with gallons of water raining all over the place, but this didn't stop the modelers. By 9:00 AM the rain had stopped, and Condor R/G was held. Throughout there were many spectacular flights, but the cake was taken by Jon Robbins of Byran, Ohio, who turned in a 2:44 flight with a "Groundhog" Condor R/G. Much credit goes to the Guernseys, Jim Sparks, and the NARCAS section for a memorable meet.

## Club History

A new feature you will be seeing in the coming months is the *Club History* column. To start off we write about the KAUAI section of Hawaii.

The KAUAI MODEL ROCKET CLUB (No. 246) of Kekaha, Hawaii, was formed on January 9, 1971. Their charter became effective January 24. This is the first chartered section in the State of Hawaii. Mr. Donald L. VanAusdeln, section advisor, has been appointed State Department Head for this area for the NAR.

The island of Kauai is the hub of the missile and space effort in the Pacific area. The section launch site is located one mile from the National Bureau of Standards, three miles from the U.S. Navy Pacific Missile Range Launch Control Complex, four miles from the Sandia Corporation rocket launching facility, and thirteen miles from NASA Station 13, Apollo space tracking complex.

Most of the senior members of the section are associated with these facilities. They have such professions as meteor-

### Flight Systems, Inc.

B3-0	B3-4	B3-6			
C4-0	C4-4	C4-6			
D4-0	D4-6	D4-8	D6-0	D6-6	D6-8
D18-0	D18-4	D18-6			
E5-0	E5-6				
F7-4	F7-6	F100-0	F100-8		

### Model Products Corp.

½A3-3m*	A3-4m*
B3-3	B6-4 B3-5m*
C6-0	C6-4

### Vashon Industries

Cold propellant Valkyrie I, II

(\* indicates New Engine Contest Certification effective June 1, 1971. Based upon public availability of engines.)

The model rocket engines listed below have been granted the NAR Safety Certification effective May 1, 1971:

### Centuri Engineering Co.

F97-0	F97-4	F97-7	F97-10
-------	-------	-------	--------

### Flight Systems, Inc.

A4-4

### Model Products Corp.

A3-2	½A3-3m	A3-4m	B3-5m
------	--------	-------	-------

This list supercedes all previous lists published in the *Model Rocketeer*.

ologists, engineers, range management specialists, ballistic analysts, computer technologists, and high performance jet pilots, just to name a few. Many of these men have active sons in the section, however many do not. Still younger members abound also. A case in point is Susumo Moore, age four, who has already built and flown several model rockets with minimal supervision.

There are a surprising number of rocketeers interested in the area, unusual because there is no local retail outlet for model rocket supplies, and all supplies must come through the mail...still that's the way many older sections got their start.

The section has been offered aid by many interested officials including the police chief, local land owners, and the facilities mentioned above. There is also good rapport with the FAA officials in the area.

Each month the section tries to have a guest speaker talk about some topic pertaining to all. In March the guest speaker was Police Chief Dewey Allen who talked about model rocketry as it concerned local ordinance regulations, and police-juvenile relations.

The section has asked others to speak in the coming months. Hopefully Kauai MRC will hear from the NASA station director, the FAA island manager, the weather bureau chief, and possibly a Sandia rocket scientist.

Rocketeers interested in corresponding with Kauai should write to Mr. Donald VanAusdeln at Box 386, Kekaha, Hawaii, 96752.

*Sections, send in your Club Histories to Chuck Gordon so we can honor your group in the coming months.*

## DEALER DIRECTORY

Hobby shops desiring a listing in the **Model Rocketry Dealer Directory** should direct their inquiries to Dealer Directory, **Model Rocketry** magazine, Box 214, Boston, MA 02123. Space is available only on a six month contract for \$18.00, or a twelve month contract for \$35.00, payable in advance.

### CALIFORNIA — Glendora

Rocket Club Service Our Specialty  
THE HOBBY BENCH  
350 W. Foothill Blvd.  
MWF 11-9, TTh 11-6, Sat 9-6, Sun 11-5

### CALIFORNIA — Monterey Park

Estes, Centuri, SAI, FSI  
SCOTTS SPORTS-HOBBIES  
145 East Garvey Ave.  
Mail Orders Accepted Phone 280-6090

### CALIFORNIA — Mt. View

Model Rocket Supplies  
SAN ANTONIO HOBBY  
413 San Antonio Rd.  
Sears Shopping Center  
9:30 to 5:30 Daily Thurs. till 9 PM

### CALIFORNIA — Whittier

Complete Selection of Model Rockets  
Estes—Cox—Centuri—MPC  
JACK'S HOBBYCRAFTS  
14710 E. Whittier Blvd. 90605  
M-Th 10-6, Fri 10-9, Sat. 9:30-5:30

### COLORADO — Glenwood Springs

Save 10 to 50% on Model Rockets  
Send 25¢ for lists and info  
BELLTRONICS HOBBIES  
PO Box 885  
81601 Phone 945-6967

### CONNECTICUT — Bridgeport

Complete Rocketry Supplies  
Is Our Specialty  
BOB'S HOBBIES  
1542 Wood Ave.  
Bridgeport 06605

### DELAWARE — Wilmington

HOBBY-ART, INC.  
4713 Kirkwood Highway  
(302) 994-0281  
9:30 AM to 5:30 PM W, Th, Fr to 9 PM

### FLORIDA — Gibsonton

Save!!! All Brands  
Write for Lists and Discounts  
PAT'S PLACE  
PO Box 118  
7:30 - 6 Mon to Sat (813) 677-6310

### GEORGIA — Smyrna

Best Selection in Georgia  
MILTON BRADLEY  
2152 S. Cobb Drive  
Phone 436-1581  
10 AM to 6 PM M, Th, Fr to 9:30 PM

### ILLINOIS — Evanston

Estes, Centuri, FSI, Space Age, MPC, Cox  
TOM THUMB HOBBY CENTER  
1026 Davis St.  
10-9 Mon thru Sat Sunday 1 to 5

### ILLINOIS — Rantoul

SLOT AND WING HOBBIES  
511 S. Century Blvd  
Open 10 to 8 892-4764

### INDIANA — Michigan City

VAILS  
Marquette Mall  
Rte 421 and 20  
10 AM - 9 PM Daily Sunday 12 - 5

### MARYLAND — Severna Park

Complete Model Rocket Supplies  
Centuri—Competition—DB Ind—SAI  
PSYCHO-CERAMICS HOBBIES  
428 Ben Oaks Drive West  
Telephone (301) 987-4395

### MARYLAND — Westminster

BOBBY'S HOBBY LOBBY  
65 E. Main St.  
Mon to Sat 10 - 9 W, Th, Fr 10 - 8

### MASSACHUSETTS — Cambridge

CROSBY'S HOBBY CENTER  
1704 Massachusetts Ave  
(617) K17-4389  
9 AM - 5:30 PM Thurs to 8:30 PM

### MASSACHUSETTS — Melrose

MIDDLESEX COIN, STAMP,  
& HOBBY SHOP  
473 Main St.  
02176 662-8319

### MASSACHUSETTS — Walpole

Rocket Supplies by Fast Mail  
Estes, Centuri, MPC, Cox  
LAWCO SALES  
PO Box 244  
Walpole, MA 02081

### MASSACHUSETTS — Wellesley Hills

Complete Rocket Supplies  
MR. WIZARD'S SCIENCE CENTER  
239 Washington St.  
9 AM - 6 PM (Th, Fr to 9 PM) 235-2486

### MICHIGAN — Muskegon

KAREL'S TOYS & HOBBIES  
2510 Henry St.  
(616) 733-1739  
9:30 to 6 Daily M & F to 9

### MICHIGAN — Saginaw

TAIT'S HOBBY SHOP  
118 S. Michigan  
793-9135  
9:30 AM to 7:30 PM Sat to 5:30

### MISSOURI — St. Charles

Centuri—Estes—MPC—Galaxy—Cox  
Largest Rocket Shop in St. Charles Cty.  
ST. CHARLES AEROSPACE HOBBIES  
559 First Capitol  
M,W,F 2:30-9, T, Th 2:30-6, Sat 9:30-6

### NEVADA — Sparks

SPARKS AEROSPACE CENTER  
Ideal Shopping Center  
1845 Prater Way  
Mail Orders  
Complete line of model rocket products

### NEW JERSEY — Absecon

AERO-TRAIN HOBBY HOUSE  
12 Station Ave.  
Mon-Fri 12 Noon - 9 PM Sat 12 to 6 PM

### NEW JERSEY — Edison

Complete Rocket Supplies  
EDISON CYCLE SHOP  
238 Plainfield Ave.  
SAI, Estes, Centuri, Flight Systems, etc.

### (Club Notes, continued)

Duration, Boost/Glide, and Open Spot Landing were flown. Overall, Doug McConnell took 1st place, Tom Sloan was 2nd, and Bruce Garvais was 3rd. The club, which has 20 members, holds monthly launches. Rocketeers interested in joining should contact Rex Wiederspahn, 7935 Vallejo St., Denver, Colorado 80221.

The Physics Club of the Central Islip Senior High School, Central Islip, New York, held its first launch in May. The flight session featured the launching of a Saturn V, and was directed by Club Advisor J. Scanlon and President Michael Schneider.

The New York Rocket Society plans a contest and discussion group session open to all rocketeers. NYRS-1, is scheduled for September 4-5, 1971. Contact James Enny, 88 Tehema St., Brooklyn, NY, 11218.

A model rocketry club has been formed in the East Longmeadow, Massachusetts area. Any interested rocketeers should contact David Anderson, 68 Hillside Drive, East Longmeadow, MA, 01028.

A new club is being organized in the northwest Waukesha, Wisconsin area. Interested rocketeers should contact William Buenger, 34605 Mariner Circle, Oconomowoc, Wisconsin, 53066.

Send your club or section newsletters, contest announcements and results, and other news for this column to:

Club News Editor  
Model Rocketry Magazine  
P.O. Box 214  
Astor St. Station  
Boston, Mass. 02123

### (Club Corner, cont.)

develop one that is easy for you to use. (I've found cards to be easier to use in a large meet and sheets easier when only a few contestants are involved.) You should have a box for the cards or a clipboard for the sheets to prevent them from blowing away.

As with any club activity, choose the time and site of the meet as early as possible and let everyone know about it. (If the public or other clubs will be invited, this is especially important.) Be certain that the events you will fly are suitable for the field (you might have trouble flying a D engine altitude event in a high school stadium). Try to schedule the meet at a time when most of your members can attend.

If your club doesn't own all the equipment that will be needed to run the meet, plan who you can borrow the equipment from as soon as possible. If you wait until



the night before the meet to start looking for stopwatches, you may end up using a sundial to time the duration events.

Select your judges; you must have at least two judges for each event (the same judges can work several events). No judge can judge during his own flight. In Research and Development, the judges should not even be entered in the event. Line up volunteers for tracking, check in, safety check, crowd control, data reduction, and any other jobs on the range before the day of the meet. Arrange these jobs so that your judges and other workers will have time to fly their own models. Some clubs have a sign-up sheet where slots are provided for each job, with crews rotated about every 45 minutes. If the sheet isn't filled, the meet doesn't begin; and, on the day of the meet, if someone doesn't show up for his job at his time, flying stops. That makes people do their share!

Now you are on your way to planning your first meet. Next month, we'll see what happens on the day of the meet (besides chaos, that is).

(From the Editor, cont.)

setting up a campsite, and housing the competitors in tents.

Army barracks, YMCA rooms, and tents are certainly not as attractive as fancy motel rooms. Neither, however, are they as expensive. The purpose of a contest or convention is to allow rocketeers to get together and fly their best models against each other or discuss their latest experimental projects. This purpose can be served without the expense of "vacation" housing.

Conventions generally run into the problem of securing adequate meeting facilities. The meeting rooms at hotels and motels are ideal but expensive. Classrooms at the local school, meeting rooms at the YMCA, or other such facilities make up what they lack in comfort by the inexpensive price. To promote communications at conventions it is imperative that rocketeers not be excluded because of the fees involved.

To save money on food, the event can include a picnic style meal. If a few parents or older club members donate their time to prepare the picnic foods, the cost to each contestant can be reduced below that being charged at most restaurants.

The ever-increasing non-rocketry costs associated with conventions and competitions can only serve to discourage the younger and less affluent participants in the hobby. But without their active participation in all rocketry events, the present growth rate will not continue and in a few years we could find ourselves in a similar position to the model airplane enthusiasts, who have a hobby in which almost all of the serious participants are adults.

Five years ago contests were inexpensive affairs. They were small and local. Any out-of-town rocketeer who needed a place to stay could easily find some local contestant to stay with. As contests have gotten bigger, most clubs have solved the housing and meal problem the *easy way*. They have gone to motels and restaurants. What we need now is for the contest and convention sponsoring clubs to give some creative thought to alternative methods of housing and feeding the contestants.

#### NEW JERSEY — Jackson

JACKSON HOBBY SHOP  
Complete Rocket Supplies  
Centuri, Estes, Flight Systems  
New Prospect Rd  
Open 7 days/week 364-3334

#### NEW JERSEY — New Brunswick

Estes, Centuri, MPC  
STEVE VARGA'S HOBBY SHOP  
57 Easton Ave.  
(201) 545-7616  
Daily 10 AM-7 PM Closed Sunday

#### NEW JERSEY — Pine Brook

P.H.C. Inc.  
RICH'S HOBBYTOWN  
13 Hook Mountain Rd  
M-F 10-10, Sat, Sun 10-6 227-2666

#### NEW JERSEY — Princeton

Complete Rocket Supplies  
MPC—Centuri—Estes—Space Age Ind.  
NASSAU HOBBY  
142 Nassau St. Princeton, New Jersey

#### NEW JERSEY — Wayne

Rocketry is only one hobby section  
TOTOWA HOBBY SHOP  
131 Boonton Road  
Open Sundays 696-5170

#### NEW YORK — Bethpage

Arts & Crafts Distribution  
NASSAU FARMERS MARKET  
Rt. 106, Bethpage  
Friday & Saturday 11:00 to 11:00

#### NEW YORK — Mt. Vernon

MODELAIRE HOBBY SHOP  
36 West First St  
Open 10-7, Sat 10-6 MO4-3232

#### NEW YORK — New York City

"World's Leading Hobby Shop"  
Complete department store of all hobbies  
POLK'S HOBBY DEPT STORE  
314 5th Ave  
New York City (212) 279-9034

#### NEW YORK — Uniondale

Biggest and the Best with the Most  
Estes & Centuri  
CARD & CRAFT  
1004 Front St  
Mon, Th, & Sat 9-6 Fr 9-9 Sun 10-3

#### OHIO — Cleveland

NATIONAL HOBBY, INC.  
5238 Ridge Rd  
749-4750  
Daily to 6 PM Mon & Fr to 9 PM

#### OHIO — Upper Sandusky

Complete Rocketry Supplies  
THE ROCKET SHOP  
640 Skyline Drive  
6 to 9 PM 294-1322

#### PENNSYLVANIA — Emmaus

JOE SEMANCIK'S  
HOBBY SHOP  
412 Chestnut St  
10-6 Daily 12-8 Thurs & Fri

#### PENNSYLVANIA — Feasterville

FEASTERVILLE HOBBY SHOP  
244 Bustleton Pike  
Open 10 to 6 357-0862

#### PENNSYLVANIA — Monroeville

LORESKI'S HOBBY SHOP  
"Miracle Mile" Shopping Center  
10 AM - 9 PM (412) 372-5155

#### PENNSYLVANIA — Pittsburgh

JOHN A. SACCO, JR., INC.  
30-32 Ingram Ave  
Pittsburgh, PA 15205  
9-5, Eve. 7-9, Sat 9-3 921-1553

#### PENNSYLVANIA — Scranton

THE DEN, INC.  
Everything in Rockets, Planes, Crafts  
Rt 6, Scranton - Carbondale Hwy  
10 AM to 10 PM 7 Days a Week

#### PENNSYLVANIA — Sunbury

SCHRADER BROS  
470-472 North 4th St  
8 AM to 10 PM (717) 286-6841

#### PENNSYLVANIA — York

RACE-O-RAMA HOBBY CENTER  
Queensgate Shopping Center  
Phone: 849-9338  
Daily 10 AM to 9:30 PM, Sunday 12 to 5

#### TEXAS — Houston

Rockets-Emblems-Photos-Toys-Kits  
Send 50¢ for catalog  
SPACE PHOTOS  
Dept MR3, 2608 Sunset Blvd  
Houston, TX 77005

#### UTAH — Ogden

Rocket Motors Our Specialty  
Mail Orders Welcome  
ROCKET TECHNOLOGY CORP.  
432 25th St.  
Ogden, Utah 84401

#### WASHINGTON — Seattle

Rocketry for the Northwest  
Nationally Known Brands  
CAMPUS HOBBY CENTER  
4738 University Way N.E.  
Open Thurs. Eves. Phone: LA5-2222

#### WISCONSIN — West Allis

GARMAN HOBBY SHOP  
8216 W. National Ave.  
476-1412  
Mon - Fri 9 to 8, Sat 9 to 6, Sun 12 to 5

#### CANADA — Montreal, Quebec

CARL'S R-C HOBBY SHOP  
5988 St. Hubert St.  
Montreal 326, PQ  
M-F 9 to 6, Th & F to 9 (514) 273-6008

#### CANADA — Toronto, Ontario

Canada's only exclusive rocket shop  
Home of the Canadian Rocket Society  
THE SCIENCE SHOP  
137 Yonge St. Arcade  
H. Diamond Lic. Supervisor No. 13

#### CANADA — Youngstown, Alberta

Canadian Mail Order  
THE BOX CAR  
PO Box 219  
Estes Centuri SAI CMR

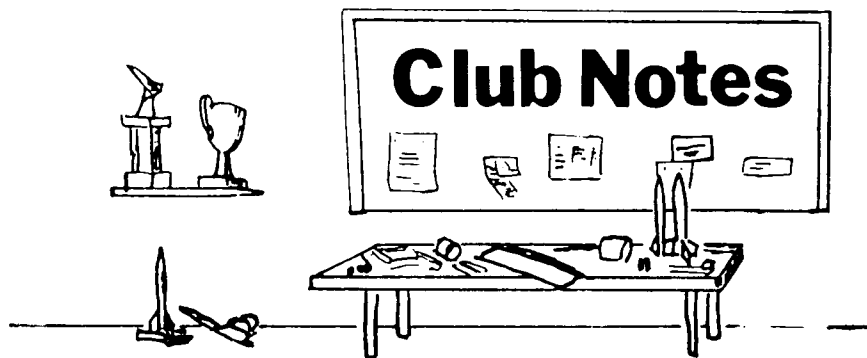

On Saturday June 19, 1971 the Atmospheric Rocket Research Association had a club launch at Maisoneuve Park in Montreal Canada. Although only a few members attended, about 30 rockets were launched. Peter Sauer flew a variation of the LeMans start test model (featured in the July '71 *MRM*, *Update Canada*). This one was a body tube attached inside a shoe box. Unfortunately the model failed to leave the rod because of an off-center launch lug. Another notable flight was an Arcas using Contest Products' Black Tracking Powder, which produced an easily seen puff of smoke at apex. Montreal area rocketeers are invited to contact the ARRA, c/o Alan Cantor, 6849 Banting Rd., Montreal 269, Quebec.

The Piedmont Model Rocket Club was formed in March, 1970 in Thomasville, North Carolina. The main purpose of the club is to teach others about model rocketry. So far, the club has launched an undetermined number of model rockets, and staged several demonstrations. This summer the club is planning a large-scale demonstration to help introduce more people to model rocketry. The Piedmont Rocket Club would be pleased to exchange news or correspondence with other U.S. or Canadian clubs or individuals. The club can be contacted through Mark Black, 206 Forest, Thomasville, North Carolina, 27360.

The Lindenwood Model Rocket Club of Howard Beach, New York recently had a competition in Hornet B/G, Parachute Dura-

tion, and Altitude. Robert Neneruso's B/G topped the 10 entry field with a 91.2 second time. Stephen Ryan's Estes Big Bertha took the prize in PD with a staggering 29.9 minutes. Rocketeers wishing to join the LMRC should contact Stephen Ryan, President, at 155-19 89th Street, Howard Beach, New York.

New Jersey's Pascack Valley Section plans a two-day Regional contest to commemorate their ten years as an NAR Section. The meet, to be held on the Columbus Day weekend, will feature Space Systems, Swift B/G, Hawk R/G, Open Spot Landing, Pigeon Eggloft, Class II Drag Efficiency, Class II Streamer Duration, and Class II Parachute Duration. Trophies will be awarded to first place winners. Interested rocketeers should contact Victor Dricks, 1547 East 21st St., Brooklyn, New York 11210.

The newly formed Glenwood Springs (Colorado) Model Rocketry Club is planning an area meet to be held during the flight of Apollo 15. The dates and events have not yet been selected, but interested rocketeers and clubs in the Glenwood-Grand Junction-Aspen area should contact Larry Evans, 921 Pitkin Ave., Glenwood Springs, Colorado 81601 for more information.

The Greater York Area Association of Rocketry, the first NAR Section in the York, Pennsylvania area, has obtained use of a fifty acre launch field. The club is presently assembling parts for construction of launch

pads, panel, and tracking equipment. Interested rocketeers should contact Larry Myers, 567 W. King St., York, PA.

Attempts are being made to organize an NAR Section in eastern North Carolina. Any isolated NAR members in or around eastern North Carolina, especially Goldsboro, Fayetteville, Greenville, Seymour Johnson AFB, or Fort Bragg should contact Al Aycock, 400 Adams St., Goldsboro, NC 27530.

A new model rocket club, the Mid-Island Rocketry Club, is being organized in the Floral Park, Garden City, Westburg, Hicksville, New York area. Rocketeers under 14 years old are invited to contact Stuart D'Alessandro, 507 Davie St., Westbury, NY

The Fanwood District of the Pascack Valley Section has now formed its own section — The Fanwood Association of Rocketry. Membership is open to rocketeers in the Scotch Plains/Fanwood, New Jersey area. Interested rocketeers should contact Earle Naumann, 43 Fourth St., Fanwood, New Jersey 07023.

On April 12th the Pennsylvania Aeronautics and Research Organization (PARO) held its first inter-branch launch day of the year. Notable performances of the launch were: a parachute duration of 213.7 seconds by a B4-4 powered WAC Corporal; an altitude of 765 feet by an A8-3 powered Sprint; and a perfect landing for a Scout in spot landing.

A new club is being formed in the northern Dallas, Texas area. Their first two launches were held with the "misfire-alley" system, but work is now underway on a rack launcher. Interested rocketeers should contact Claude Lebrum, Jr. at 241-3060.

A new model rocket club has been formed in Groton, Massachusetts. Interested rocketeers should contact the club c/o Inn at Groton, P.O. Box 455, Groton, Mass. 01450.

The Tonawanda Aero-Space Club is a growing model rocketry club on the Niagara River in New York. Several members are leaving for college, and the club is looking for new members to replace them. Rocketeers interested should contact John Carr, 119 Kohler St, Tonawanda, New York 14150.

A model rocket club has been organized in the Shreveport-Bossier City, Louisiana area. The club has planned a demonstration launching to commemorate the first manned lunar landing on July 20th. Rocketeers interested in further information about the club should contact Mark Knox, 1117 James St., Bossier City, LA 71010.

Ronald Finkelstein is attempting to form a model rocket club in the Bronx, New York. Interested rocketeers should contact him at 1475 Grand Concourse, Bronx, New York 10452.

On May 16th the Western Disasters Model Rocket Club in Denver, Colorado held a rocket contest open to all rocketeers in the Denver area. Parachute Duration, Streamer

(Continued on pg 46)

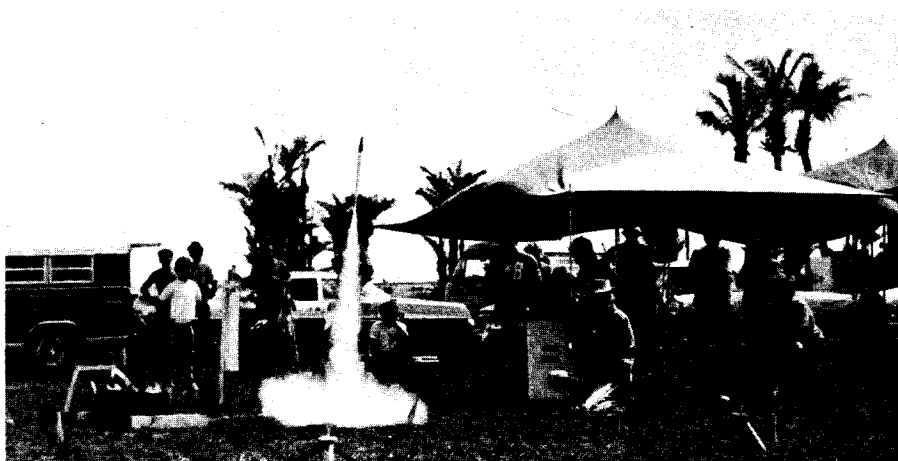

Florida's Boward County Model Rocketry Association remained active throughout the winter with a launching on February 21st. The Spring Competition was held May 15th, and a Summer Competition is now in the planning stages. The club uses a Misfire Alley launching system.

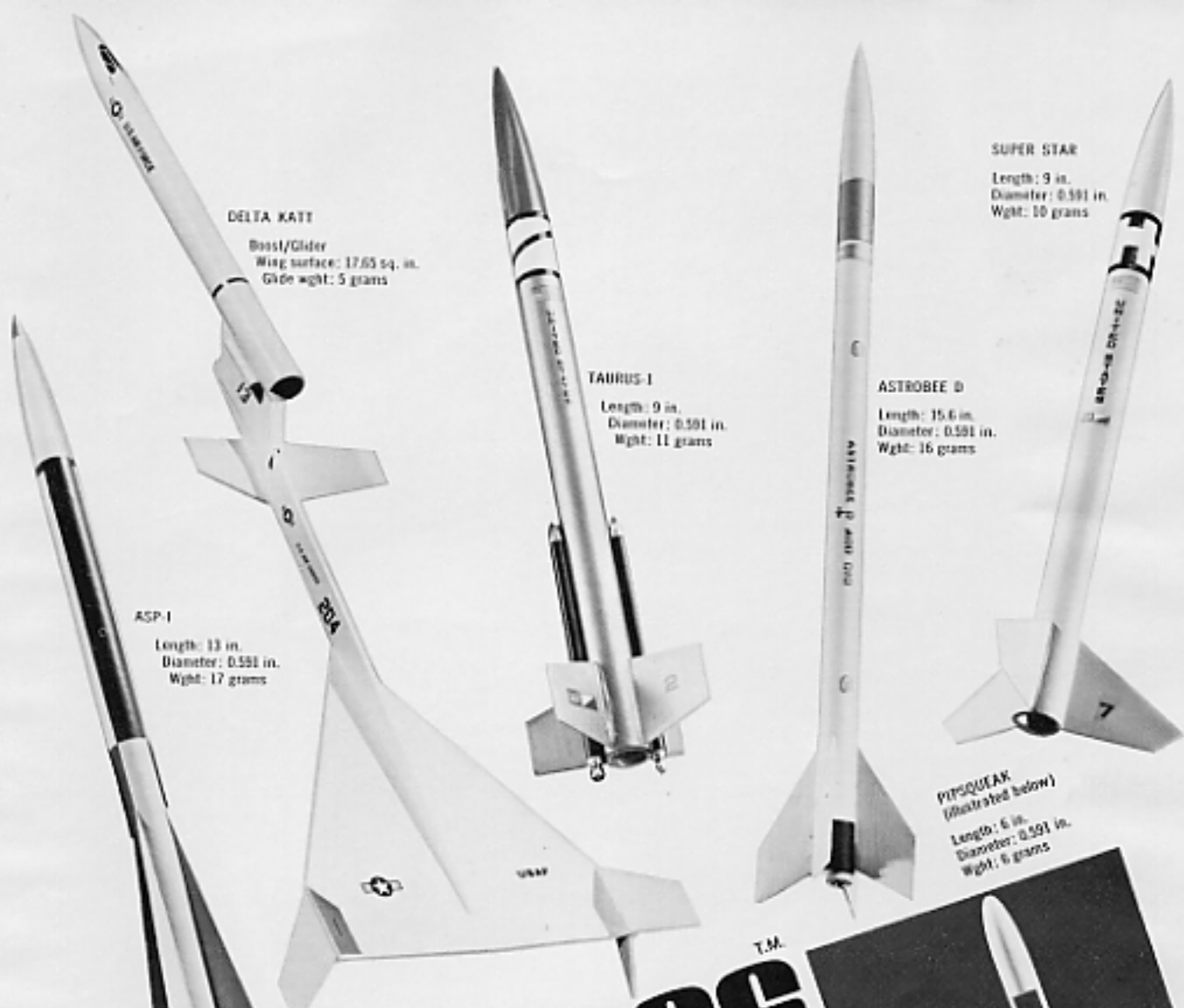

**DELTA KATT**

Boost/Glider  
Wing surface: 17.65 sq. in.  
Glide wght: 5 grams

**ASP-1**

Length: 13 in.  
Diameter: 0.591 in.  
Wght: 17 grams

**TAURUS-1**

Length: 9 in.  
Diameter: 0.591 in.  
Wght: 11 grams

**ASTROBEE D**

Length: 15.6 in.  
Diameter: 0.591 in.  
Wght: 16 grams

**SUPER STAR**

Length: 9 in.  
Diameter: 0.591 in.  
Wght: 10 grams

**PIPSQUEAK**  
(Illustrated below)

Length: 6 in.  
Diameter: 0.591 in.  
Wght: 6 grams

# mini rocs<sup>TM</sup>

Maybe it's not fair. But the new MPC Minirocs are shattering all the records without even trying. They can fly higher and faster than ever before possible. And it's not even hard because they're built around the revolutionary Minijet engines. Minijets are the tiny engines that produce the same power as the regular ones. With engines that weigh up to 46% less and Minirocs that produce 36% less drag, record breaking can be your thing too! As for all the former record holders . . . well, sorry about that guys!

# mini jets<sup>TM</sup>

These are the key to the Miniroc revolution. Check the specs, look at the comparative diagram. That's why Minirocs are so slim. Available in 1/2A3-3m, 1/2A3-5m, A3-4m, A3-6m, B3-5m and B3-7m.  
Outside diameter: 13.00mm-0.512 in.  
Length: 57mm-2.25 in.



For an MPC Miniroc catalogue send 15c to: MPC/Miniroc Catalogue, Dept. Q 126 Groesbeck Hwy., Mount Clemens, Mich. 48043



**MODEL PRODUCTS**  
126 GROESBECK HIGHWAY  
MOUNT CLEMENS, MICHIGAN  
48043



Step into the real world of space

*see your hobby dealer*



A SUBSIDIARY OF DAMON

DEPT. 31-M / PENROSE, COLORADO / 81240