

MODEL ROCKETRY

August 1970
60c

The Journal of Miniature Astronautics
Incorporating THE MODEL ROCKETEER

NART-1
Contest Coverage



PIVOT LAUNCH

TOWER PLANS

FOXMITTER II

TEMPERATURE SENSOR

EFA PAYLOADER

SPORT DESIGN

RD-107 "VOSTOK"

SCALE DATA

"BIO-1" PAYLOAD

ROCKET PLANS

TITAN III-M WITH

WORKING STRAP-ONS

BOEING WIND

TUNNEL PLANS

FLOP-WING B/G

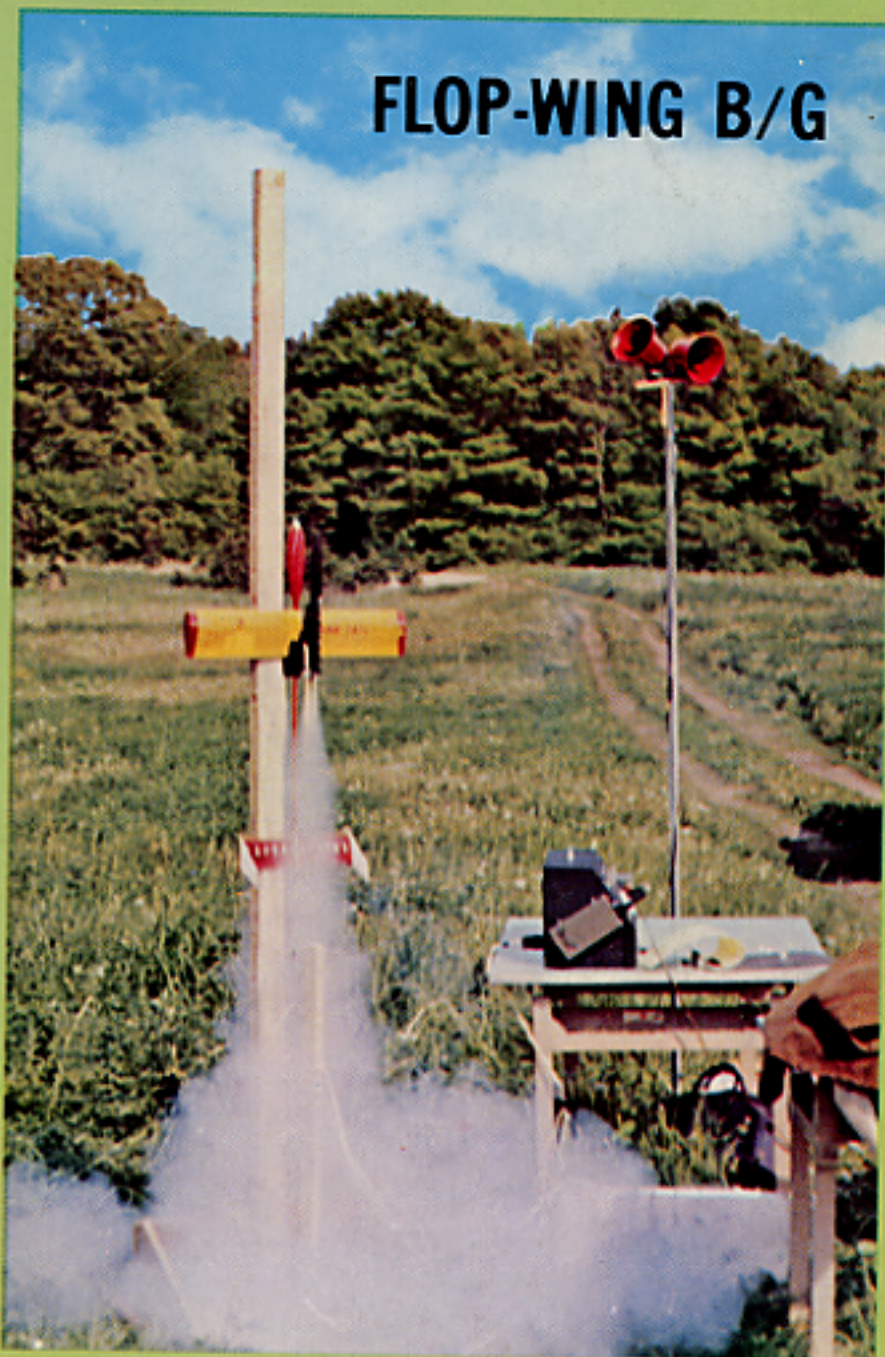



Learn all about Model Rocketry!

Centuri

The quality leader in High Flying Rockets

Send for the new, exciting 1970 Edition
of CENTURI MODEL ROCKETRY.
You'll find all the answers about the
fastest growing hobby in the U.S.



CENTURI

P. O. Box 1988 Dept. K100
Phoenix, Arizona 85001

Please send me your 1970 Model Rocketry Book!
I enclose 25¢. (No Stamps Please.)

NAME _____

ADDRESS _____

CITY _____ STATE _____

ZIP _____ Full refund on 1st Order. AGE _____

Editor and Publisher George J. Flynn
 Managing Editor Gordon K. Mandell
 Technical Editor Douglas Malewicki
 Assistant Editor Robert B. Singer
 Assistant Editor Robert Parks
 Business Manager Jerome Apt, III
 Distribution Manager Kevin P. Brown
 Technical Correspondent George J. Caporaso

Cover Photo

Liftoff! Bob Parks' "Flop-Wing" Condor boost/glider lifts off on a demo flight. Powered by two FSI E-engines, and two C-engines, the "flop-wing" is a radical new concept in variable geometry B/G's. See Bob's article on the development of this design on page 9. (Photo by G. Mandell.)

From the Editor

As any competition sport matures, new concepts are developed which render outmoded all previous designs or methods. In the auto racing field, just recently, the turbine car has been prohibited from certain competitions. The "spitball" was banned in baseball. Each of these would certainly have revolutionized the nature of the competitive sport if they had been allowed to continue. In fact, whenever some revolutionary new development is introduced to a sport there are only two choices: 1) to ban the new development by common consent and allow the sport to continue unaffected, or 2) to accept the new development and change the nature of the competition. With the many new technological developments being introduced to model rocketry, we can expect to face these choices in several areas of competition. How will the decisions be made? What decisions should be made?

Right now, with the re-introduction of tower launchers, we face one of these decisions. At recent major competitions it is a fact that those rocketeers using towers are winning altitude and design efficiency events more often than those rocketeers not using towers. Whether they are winning because they are better modelers flying better rockets, or because of luck, or because the tower offers a significant competitive advantage has yet to be determined by experiment. However the evidence that a tower offers a competitive advantage is suggested strongly enough that more and more rocketeers are showing up at rocket meets with their own towers. Some of the towers are, in fact, so crudely constructed that they can't possibly offer an advantage over even a rusty launch rod. Many other towers are precision constructed devices which certainly contribute to an advance of the state-of-the-art. Should the tower be banned?

What about the closed-breech launcher? Here at least the competitive situation is more clear. The closed-breech launcher in theory (and almost certainly in fact) offers a distinct competitive advantage to the rocketeer. Thus if one rocketeer in a contest is

(Continued on page 32)

The "Flop-Wing" Boost/Glider	9
A new concept in variable-geometry B/G's by Bob Parks	
Temperature Sensor for the Foxmitter	14
A new, and more stable temperature sensor design by Richard Fox	
The EFA Payloader	17
A unique demonstration/sport payload design by Randy Black	
Titan III-M in Semi-Scale	18
This month's Escape Tower features a set of MOL plans by Bob Parks	
NART-1: NARCAS Record Trials	22
On the scene coverage of the first attempts to get Condor B/G's to fly by George Flynn	
"BIO-1" Payload Rocket	27
Part I of the plans for a Foxmitter mouse lofter by Alan Stolzenberg	
The Wayward Wind: Wind Tunnel Plans	29
A set of plans for a home-built wind tunnel . . . from the files of the Boeing Aircraft Company by Gordon Mandell	
Astroscale Data: The RD-107 "VOSTOK"	34
More photos and info on the Russian manned launcher by G. Harry Stine	
Automatic Computation for Rocketeers	38
Some corrections and comments on previous columns by Charles Andres	
Regular Features	
From the Editor	1
Letters to the Editor	2
From the Launching Pad	6
New Product Notes	15
Modroc Calendar	31
News Notes	32
Reader Design	33
Club Notes	48
THE MODEL ROCKETEER (National Association of Rocketry)	40

Worldwide newsstand distribution by Eastern News Distributors, Inc., 155 West 15th Street, New York, New York 10011. Hobby shop distribution by Kalmbach Publishing Co., 1027 North Seventh St., Milwaukee, Wisconsin 53233.
 Second class postage paid at Boston, MA and at additional mailing offices.
 Model Rocketry magazine is published monthly by Model Rocketry, Inc., 595 Massachusetts Avenue, Cambridge, MA 02139.
 Subscription Rates: US and Canada \$5.00 per year, \$3.00 for 6 months, 60 cents for single copy; Foreign \$9.00 per year, \$5.00 for 6 months, \$1.00 for single copy. For change of address please notify Subscription Department, Model Rocketry, Box 214, Astor Street Station, Boston, MA 02123 at least 6 weeks in advance. Include former address or mailing label with the new address.
 Material submitted for publication should be accompanied by a self-addressed, stamped envelope if return is desired. Model Rocketry can assume no responsibility for material lost or damaged, however care will be exercised in handling. Articles accepted for publication will be paid at the rates current at the time of publication. Letters, contest information, news, announcements, etc. are assumed to be submitted gratis.
 Undeliverable copies, notices of change of address, subscriptions, and material submitted for publication should be submitted to Model Rocketry, Box 214, Astor Street Station, Boston, MA 02123.
 Printed in USA

© Copyright 1970 by Model Rocketry, Inc.



A HANDFUL FOR YOUR PLEASURE

Shown in the photograph above is our new Commander Gem SEB Receiver for use with the Bentert actuator, also shown; and two 50 mil button nickel cells.

Weight of receiver and small Bentert is less than 1 ounce. Depending on your battery choice you can keep the weight under 1 1/4 oz.

The receiver is compatible with our R/O Pulse Commander Transmitter, and this may be had separately or you can add this airborne package to your present R/O system.

COMMANDER MICRO GEM RECEIVERS

The Micro Gem Superhet is available in two models. Thousands are in satisfactory use throughout the world. The receiver measures 1 1/16 x 1 1/2 x 1/2 inches. Weight of the bare receiver less hook up wires is .5 ounces. With light weight hook-up wire is .7 ounces. Operation is on 2.4 volts with phenomenal range; may be used with 3 volts.

The two models are the DE, which has a double ended output to feed into the Adams style actuator, and the SEB, which is designed for the Bentert type of actuator only.

No. 12K2—Commander DE Gem Rx \$31.50

No. 12K3—Commander SEB Gem Rx 30.75

(For the Bentert only)

Available all 27 MHz except 27.255.

ADAMS ACTUATOR

Full listing in our catalog.

COMMANDER R/O TRANSMITTER

The foregoing receivers are compatible with our Commander Pulse Transmitters. Requires 9 volt battery of the M1603 type.

No. 11K1—Commander R/O Tx \$42.50

Available all 27 MHz except 27.255.

BENTERT ACTUATORS

These are single coil units with magnetic return. Small model weighs 7.5 grams and draws 50 ma at 3 volts. Large model is 15 grams and draws 80 ma at 3 volts.

No. 14K1—Small Bentert Actuator \$9.95

No. 14K2—Large Bentert Actuator 9.95

BATTERIES FOR THE SMALL ONES

Your selection of batteries will depend largely on the size application.

SILVER OXIDE

Provide 1 1/2 volts each, are not rechargeable. With the Commander Gem SEB and small Bentert you can expect an approximate life of 90 minutes. Weigh 2.2 grams each, .46 x .21", 1 1/2 volts.

No. 38K32—Mallory MS76 Silver Oxide Cell, each \$1.50

50 MA BUTTON NICADS

Voltage potential of 1.25. Rechargeable in 12 to 16 hours at 5 ma. Are .606 diameter by .230" thick. Weight 3 grams.

No. 38L4—Nicad B50T with tabs, ea. \$1.39

Send \$1.00 for our Handbook-Catalog, contains much needed information about Radio Control. Your \$1.00 is refundable on your first order of \$5.00 or more.

ACE RADIO CONTROL, INC.

Dept. MR

Higginsville, Mo. 64037



Closed-Breech Launchers?

In regards to the recent banning of the closed-breech launcher by the Washington State Model Rocket Association for all contest use (except Research and Development), several points of question have recently come to our attention.

We have in our sport a form of evolutionary process which may be compared to classical biological evolution, that is, the theory of survival of the fittest. It is quite easy to see in competition rocketry a distinct similarity between winning contest vehicles. This similarity is achieved by copying clearly superior (that is, winning) design features and, hopefully, addition of new concepts by the rocket builder. To stop this evolutionary process by the outright banning of a superior concept can only inhibit the growth and vitality of the sport. We have seen in other sports (most notably auto racing, with its banning of turbines, four wheel drive, etc.) that such action can only result in the detriment of the sport. It should be obvious by this point that we are specifically referring to the banning of the closed-breech launcher from most types of competition.

What we propose is not a lifting of this ban, but rather a modification to the exist-

ing rules that would give the closed-breech launcher no clear-cut superiority over other well designed launch systems. An automatic ten percent reduction in performance for closed-breech launchers would bring them down to the point where they no longer have any significant advantage over conventional launchers. This will permit our evolutionary process to continue. Those who desire to experiment and hopefully to introduce new concepts will be permitted to do so while being able to actively utilize these new concepts in competition. When, after a sufficient length of time, we have more data on closed-breech launcher performance, we can update our present ruling to maintain their non-advantageous status, if necessary.

Thus we urge that our concepts be considered and adopted so that our sport can retain its traditional status of technical advance and innovation.

Richard Dierks, President
Art Bozlee, Range & Operations
Richmond Model Rocket Society
Richmond, Washington

Relics of the Early Days

In the January issue I read the article *Return to Green Mountain* and about Model

Tempus-Fugit

The only kit specifically designed for competition. Bryant Thompson's NAR Record Holder, the Tempus Fugit holds:

4 National Records

1 World's Championship

Competition Rocket

Now At Your Local Hobby Shop!

Send name of your nearest dealer and receive free catalog.

SPACE AGE INDUSTRIES

714 RARITAN AVE.

HIGHLAND PARK, NEW JERSEY 08904

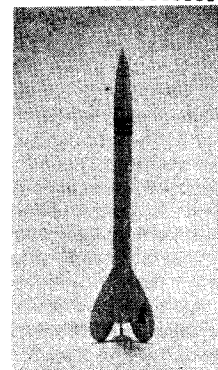

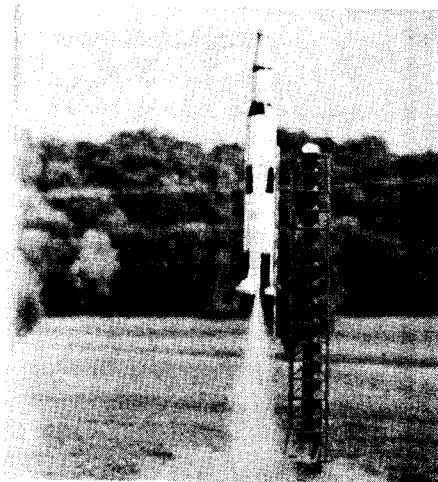
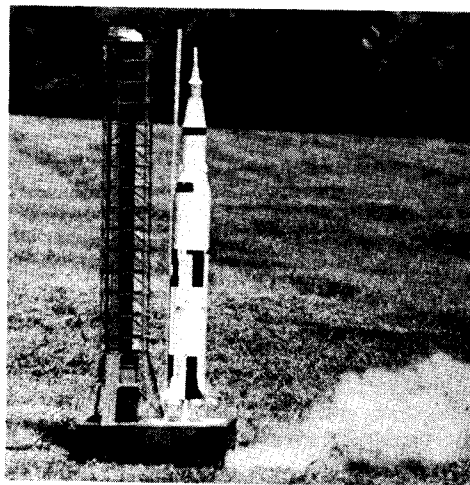
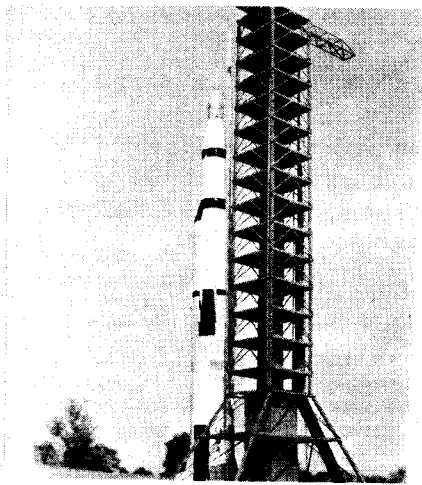

A scale Saturn V launch tower has been constructed by John Hitzeman of Clayton, Missouri. The rocket was built from an Estes kit, while the tower was scratchbuilt.

Photos by John Hitzeman

Missiles Inc. Well, a few days ago my father was getting some tools out of his old tool kit in the car and he found an oil soaked piece of paper. It was still bearly readable... an instruction sheet for a Model Missiles A4 engine. When he showed this to me I decided to write this letter.

It seems that in the late '50's and early '60's my older brother flew the Aerobee-Hi and many other rockets. I now have a piece of one of his rockets and parts of his launcher. I thought you might like to know about this find.

William Bahnke, NAR #16142
Monticello, Illinois

MMI engines don't seem to be as rare as we might suspect. A number of rocketeers have reported in recent weeks the discovery of A4 engines with the MMI markings.

Saturn Tower

Enclosed are three pictures which I took, developed, and printed myself. They are of an Estes Saturn V and a scratchbuilt tower, both built by myself. The tower was completely scratchbuilt out of balsa wood, cardboard, and plywood. Incorporated in the base is a flame chute used to vent the engine exhaust away from the tower. The rocket and tower together took about four weeks to build.

Picture number one is a close up of the rocket in the tower. Number two is of the rocket shortly after ignition. Notice the effect of the flame chute as it vents the exhaust pushing small pieces of grass and

CORRECTION

A typographical error appeared in the advertisement for launch rod pivots available from Darryl Henderson, 26 Knight Avenue, Marblehead, Mass. 01945. The correct price of the heavy duty launch rod pivot is 70¢ each, or 6 for \$3.70.

mud into the air. Number three was taken later and from a different angle. This time the exhaust is going to the left rather than to the right.

As of this time I have launched the rocket five times, each time from the tower. I have had five highly successful flights. I am now in my sixth year as an NAR member and I have greatly enjoyed rocketry and your fine publication.

John Hitzeman, NAR #5924
Clayton, MO

A scale Saturn lifting off a semi-scale tower is perhaps the most impressive model rocket which can be used for demonstration launchings. In this case, even the mud being tossed into the air adds additional realism to the launching. When the Apollo-9 lifted off from Complex 37-B at Cape Kennedy many of the fire resistant bricks in the flame trench were loosened, and tossed into the air. Driven by the force of the exhaust, hundreds of these bricks were thrown over a thousand feet from the base of the launcher. One of the bricks ripped a hole in a stop sign located 500 feet from the base of the pad. Others hit a security fence even further away, and ripped parts of the fence off the fence pole. Scaling those bricks down to 1/100th scale, perhaps those blobs of mud come out just the right size.

-GJF

Convention Proposal

I would like to propose to you an idea of mine. Since I became a member of the NAR, I have noticed that there are a number of Conventions held each year. To my knowledge they consist of:

1. Pittsburgh Spring Convention,
2. M.I.T. Convention,
3. South Western Model Rocketry Conference,
4. Canadian Convention.

I believe that all these conventions serve a very good purpose and should continue to be held. However, what I would like to see is a National Convention held annually and sponsored by NAR HQ. It could be held in

Order FSI By Mail

MICRO kit w/2 A4-4 engines	\$2.00
STAR GAZER two stage kit	\$2.25
OSO payload rocket	\$4.00
NOVA for F-engines	\$2.25
VOYAGER w/payload capsule	\$3.50
SPRINT for Chute Duration	\$2.25
Engines - A, B, C, D, E, F - write for prices and shipping information. Send 50¢ for a complete catalog.	

FSI Mail Order
5654 South Windermere
Littleton, Colo.

P D

1/4 MIL ALUMINIZED MYLAR CHUTE MATERIAL

For duration competitions use the lightest, thinnest chute material available. This 1/4 mil mylar is aluminized on one side for easy visibility. You can fit a 36 inch chute in an 18 mm standard tube. One 56 inch by 10 foot sheet is enough for two 56 inch diameter competition chutes, or three 36 inch chutes. Order today!

Only \$5.00 per sheet

Rocket Equipment Company
Dept. RS
10 Mulberry Ave.
Garden City, New York 11530

Rocketeers from 8 to 80 . . .

Launch Like The Pros!!

Adapter converts your launcher to any tripod in seconds for just \$1.65!



- Eliminates standing on your head to launch!
- Instant angle control

Clubs and sections - write for information on the finest multiple launch system available.

Dealers and distributors inquiries invited.

Same day PP paid.

NO MORE MICRO CLIP SHORTING!!

Insulated, heat resistant alligator clips with lead wires soldered and ready to splice into your electrical system. JUST 90c. pr. Send now for your next launching.

ZIP CODE PLEASE !!

AUSTIN MANUFACTURING COMPANY
301 South Street-- Chardon, Ohio 44024

- () For 1/8" Rod Launcher \$1.65
- () Estes, MPR, all other \$1.85
- () Insulated Clips 90c

Name
 Street
 City State Zip

some predetermined city each summer, preferably after the NARAM. The reason I specify summer as a time to hold it is that many junior members would be able to attend as school would be out.

I believe that a Convention such as this would be very beneficial to the sport of model rocketry. It could be held for a longer period of time than the others, and with this additional time you could schedule many guest speakers and have more discussion groups and symposiums.

I believe that if this Convention was publicized and the NAR urged members to attend the turnout would be quite favorable. Moreover, by holding it in a different city each year, every section of the country could be reached at some time or another.

I realize that this would be quite an amount of work each year but I believe it would be worth it in the long run. If there are more conventions needed, and I think there are, then I would think HQ would be the first to organize one.

Jim Brown, NAR #13905
Bay Village, Ohio

Unfortunately, the NAR, like most other hobby organizations, is run by a volunteer effort. At present, NAR HQ consists of one overworked secretary and several Trustees who happen to live in the HQ area and are thus called upon to contribute their time to keep things operating. The Contest Board has enough trouble trying to keep the Nationals going each year. Though rocketeers only see their work during the week of the NARAM, work on NARAM-12 actually started within a few weeks of the close of NARAM-11. Preliminary site selection work, etc. has already started for NARAM-13. Putting together a successful Nationals is a full year effort.

Likewise, running a successful Convention requires almost a full year of preparation. Rooms, speakers, etc. must be arranged for many months in advance. To burden the already overworked HQ staff with another long term project would cause serious problems.

I'm sure, however, that if there is a large

scale response from NAR members favoring your proposal, HQ will look into a way to expand the technical conferences. Nothing happens overnight in a volunteer organization, but if enough people want something and are willing to do the work to bring it about, it usually happens. —GJF

T-Bird a Sky Slash

I was quite surprised to read John Belkewitch's article on the *Thunder-Bird* B/G and not see proper credits as well! I must say that the research and writing of the article are on the best level, but I do feel that Larry Renger deserves credit for the design. I will, however, testify to the ability of the *Thunder-Bird? Sky-Slash!* I flew mine to a third place in both Sparrow and Swift Leader Division competition at NARAM-11. My only modification to the original Renger design, as contained in the Estes plans, was the use of a BT-50 engine tube identical to that suggested by Mr. Belkewitch. Again it was a fine article, but give credit where credit is due.

Cadet Dave Newill
USAF Academy
Colorado Springs, Colorado

The outline of John Belkewitch's Thunder-Bird is indeed quite similar to Larry Renger's Sky Slash. Recall, however, that the Thunder-Bird started out as a research project to develop a durable bird which could withstand the high-thrust engines now available. The problem most often experienced when using C, D, and E engines on B/G's is wing structure failure. To solve this difficulty, John Belkewitch developed a strengthened wing (not at all similar in cross section to the Renger wing) for use on the Thunder-Bird. Try one out with a big engine only if you have a very large flying field, or don't mind loosing the B/G.

Direction Finder

I would like to know how much it would cost to buy a simple, effective, and cheap



Valkyrie Rockets! Close to the real thing!

Now you can build and launch a rocket that lifts off like Saturn 5! Only Valkyrie has liquid fuel to give you authentic blast-off and performance. Control separation with special timer system. Metal construction, electric firing, parachute recovery, aerospace engineered realism.

Non-flammable, non-explosive. Available anywhere in the U.S.A. See your hobby dealer today, or send for FREE illustrated booklet on rocketry.

VASHON INDUSTRIES INC.
Box 309 MR, Vashon, Washington 98070



Spacemaster Enterprises
 P.O. BOX 424
 WILLOUGHBY, OHIO 44094
 DEPT. MR
 SPACE & ROCKET MODEL KITS
 We carry MPC, SPACE AGE IND., REVELL,
 AURORA, LINDBERG, HAWK, VASHON IND.,
 AMT, L.M. COX ——— 25¢ for Catalog &
 FREE Color Print of THE APOLLO 11 Lift-Off
 — Complete Mail Order Service —

radio direction finder. The reason I'd like to know is because the last time I went launching I lost three of my best performing rockets. I believe that if I was able to find out the direction they went, I would have lost only one.

Larry Palonis
New Hyde Park, New York

Look no further, a simple radio direction finder was featured in the July 1969 issue of Model Rocketry. Dick Fox developed a simple conversion for a standard walkie-talkie which allows it to be used as a direction finder when a "Foxmitter" is carried on the vehicle. Dick reports that he has recovered several Camroc carrying vehicles which would have been lost without the direction finder. Complete plans are in the July 1969 MRm, available from Back Issues, MRm, Box 214, Boston, MA 02123 for only 75¢.

Promoting Public Awareness

I have enjoyed reading your publication and your editorials since your magazine first began.

I want to congratulate you especially on the "From the Editor" on page 1 of the June 1970 issue. Promoting public awareness of and interest in model rocketry is very important. We at Estes have attempted to help every group who has come to us for assistance in providing ideas for demonstration programs and assistance in promoting model rocketry. In addition to presenting demonstrations at such activities as YMCA meetings, parks department programs, summer school enrichment classes, and demonstration launches at Little League or similar baseball games which are held before dark, some clubs have arranged evening programs which included movies instead of live launches to civic groups.

Please let us know any time we may be of assistance in helping groups that wish to help sponsor such activities.

Robert L. Cannon
Executive Director
Communications Division
Estes Industries
Penrose, Colorado

Experimental Projects

I think that your magazine is excellent and helps greatly to promote the sport of model rocketry. I enjoyed reading the "Foxmitter" plans and I'm going to build the "Foxmitter-2" as soon as I collect the parts. However, I'd like to see more scientific experiments that could be carried out with a model rocket. In the November 1969 issue I read how a model rocket was used to seed a cloud. Personally I think many other rocketeers would enjoy hearing more about these and other experiments.

Garry Spence
Bidgerville, Pennsylvania

Scale Data

HELP!!! I have been having a lot of trouble with my scale research. Mainly because I vowed that I would find scale drawings and pictures of Russian space vehicles and rockets.

Recently part of my pain was eased when you featured excellent scale plans for the Vostok in the May issue of MRm. Another help was the MPC Vostok plastic rocket kit. There is one setback, the hobby shop in which I buy rockets was affected by a trucking strike and no rockets have come in.

In your December 1969 issue there was a picture of T. Krol of Poland with a scale model of the Soviet Soyuz rocket and spacecraft. My friends asked me to ask you to draw scale designs or tell us where to get scale designs. If they are not available, please publish photos and detailed drawings of other Soviet vehicles.

Jory Heinel
Glenview, Illinois

That's quite a large order — detailed drawings and photographs of Soviet spacecraft and rockets. NASA would give a lot to get their hands on some material like that. I hope you enjoyed the Vostok detailed drawings and photos featured in the July and August 1970 issues of MRm.

The only source we know of for photos is Rocket Equipment Co. (10 Mulberry Ave., Garden City, New York, 11530) which has a series of 6 Vostok color slides available for \$5.00. See their ad in this issue for more info.

As for Soyuz data . . . well, we do have a modelling sketch of the same quality as the Vostok which appeared in the May 1970 MRm. Also a few photos. We'll probably be putting a Soyuz article together for one of the winter issues of Model Rocketry. In the meantime, Model Rocketry will continue to feature scale articles on US and International rockets and missiles.

PLASTRUCT great modeling shapes!

Angles, 'H' columns, beams, tees, channels, tubing in square, round, or rectangular, strip and sheet stock PLUS hundreds of parts for detail realism! Plastruct is the quality model plastic. Dream up what you will, Plastruct can make it happen!

Big 1970 catalog — at your dealer or send 50¢ coin

Plastruct, Inc.

Dept. MR, 1621 N. Indiana St.
Los Angeles, Calif. 90063

SPACE EMBLEMS



3" full color, finely Swiss Embroidered. APOLLO 7 thru 13, plus NASA, SNOOPY, AMERICAN FLAG. Set of 12, \$9.00, or may be purchased individually at \$1.00 each. Mail check or money order to:

SPACE PHOTOS, DEPT. MR2
2608 Sunset Blvd., Houston, Texas 77005

SUPPORT

AEROSPACE EDUCATION

ADVANCED AND PROFESSIONAL ROCKETEERS LOOK TO FSI FOR LEADERSHIP



then you need FSI superior rocket engines and flight model kits.

FSI OFFERS THE ONLY COMPLETE SERIES OF NAR APPROVED ROCKET ENGINES, A THROUGH F.

FSI airframes (kits) are all designed to high aerodynamic standards, and are wind tunnel proven. FSI's many and varied kits have also proven in competition events to be the standard of the advanced modeler.

FSI products are available at most of the better hobby shops. If your dealer does not stock the FSI line, ask him to write for our complete catalog and terms. If you wish to have your own catalog, send 25 cents to:

"The Home of the Proud Birds that Love to Fly"

Flight Systems, Inc.
Box 145 K
Louisville, Colo. 80027

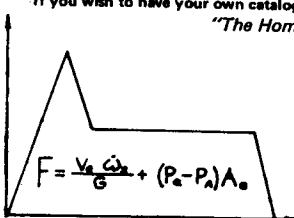

LECTRO I

Ultra Light Weight Competition Model, featuring a plastic nose cone, airfoiled fins, and an aluminized mylar ¼ mil chute. Only \$1.50 plus 50¢ shipping and handling.

Catalog on Request



LECTRO - SPACE - DEVELOPMENT
912 COLUMBUS AVENUE
BAY CITY, MICHIGAN 48704

ALL NEW ...

FOR 1970

- Improved plastic fins
- Lightweight body tubes
- Plastic nose cones
- Kits and accessories
- "Pop" launch lugs

C.M.R. BOX 7022 MR
ALEXANDRIA, VA. 22307

Send \$.20 for 1970 catalog

Mr. Dealer

Now you can buy FSI rocket supplies from their newly appointed distributors. Write for terms.

Model Car Products
& Rocket Supplies
1087 South Gaylord
Denver, Colo. 80209

For Contest Use

Precision

STOPWATCH

This stopwatch, with 1/10 second timer, was designed for contest timing. Separate start-stop and reset buttons allow you to stop the watch when the PD or B/G goes out of sight and restart it when it comes into view again. Sweep hand completes one revolution of the dial in 30 seconds. The 15 minute register allows long duration timing. Start-stop button is at the crown, and the return to zero is with a side push button. This watch has a seven jewel movement and chrome case.

ONLY \$19.95 postpaid
Rocket Equipment Company

Dept. RS
10 Mulberry Avenue
Garden City, New York 11530

FROM THE



LAUNCHING PAD

As reported a few months back, the Washington State Model Rocket Association is flying a Payload Boost Glide competition event. Under the rules the B/G must carry a standard NAR/FAI one ounce payload in the duration event. Initially the results were poor. Like most new events, there were few entries... and like most B/G contests, there were few successes. Recently, however, WSMRA members have been having increasing success with the Payload B/G event. Just recently James Pommert of the South Seattle Rocket Society broke *one minute* flying a modified Manta carrying a one ounce payload. Flying at the 2nd WSMRA Northwest Regional Championships held on May 17th, Pommert shattered the 45 second WSMRA record previously held by Mike Underwood with a 61 second flight. Aside from the Washington State activity we've heard no reports of Payload B/G activity elsewhere in the country.

The MIT Section is planning a "mini-competition" to evaluate the possibilities of small field model rocket contests. Clubs organized in suburban and city areas, where launch fields are frequently small or non-existent, usually have to travel long distances to find a good launching field. The MIT Section, located in the city of Cambridge, Massachusetts, generally travels over 40 miles to its regular launch site. The "mini-competition" site, MIT's athletic

field, is located only a quarter of a mile from the club room.

Events scheduled for the meet include Hornet B/G with a ¼A limit on engine size, Class 1 Streamer Duration with a ¼A limit on engine size, and Class 1 Parachute Duration with a ¼A limit on engine size. In addition, it has been proposed that all rockets leaving the flying area, and thus landing in the Charles River or on top of one of Cambridge's numerous factories which line the field, will be DQ'ed.

A quick look at the Malewicki charts indicates that even a small Hornet B/G will go to less than 100 feet when powered by a ¼A engine. The emphasis will therefore be on the transition from boost to glide. A good, fast transition could mean as much as 50 feet of gliding altitude, and a 50% increase in duration. Emphasis in the Streamer Duration event will be on altitude, with almost 200 feet being attainable with a ¼A. The PD event will be more of a problem. The more parachute you put in, the more weight you add, and the lower the altitude. I expect we'll see quite a few ¼ mil thick chutes entered in this event.

Other clubs are also thinking along the lines of mini-events. A recent issue of *The Tracker*, newsletter of California's Southland Section of the NAR, contains an editorial calling for the establishment of a Class O Parachute Duration event. They point out that when flying from small fields

MAIL ORDER HEADQUARTERS

**DON'T BE LEFT OUT OF AMERICA'S
NEWEST, MOST EXCITING HOBBY!**

MODEL ROCKETRY SUPPLIES ARE AS CLOSE AS YOUR
MAIL BOX ----

**ESTES, CENTURI, MINI-MAX, FLIGHT-
SYSTEMS, MPC, COX, AMROC, SAI, CMR,
SEMROC, MITS, ENERJET, VASHON,
COUNTDOWN**.... SEND 50¢ AND WE'LL MAIL

YOU OUR LATEST CATALOG

orange blossom hobbies inc.

1975 N.W. 36th STREET dept. MR
MIAMI, FLORIDA 33142

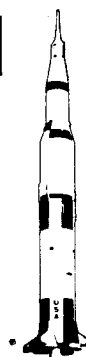

even Class I PD rockets drift out of the field. The editorial observes that if a Class O PD event is established "the contestant can be assured of getting his rocket back on the small field, so winning is a matter of building a good parachute and a good rocket to carry it. New innovations would start to appear — new hemispherical 'chutes, featherweight boosters, new materials, and more consideration for altitude capability."

As this hobby becomes increasingly popular in the densely populated city and suburban areas, more and more rocketeers will be flying from smaller and smaller fields. Let's try experimenting with these low-power events now! Many contest directors have already imposed total-impulse requirements consistent with field size on Eggloft events. There doesn't seem to be any reason why a club can't fly a restricted impulse Class I PD, to evaluate the possibilities of a new contest event. In fact, anyone who has an idea for a new event should fly it informally at a fun flying session or a contest several times to assess its practicability before proposing it to the Contest Board. The experience of having flown the event, and being able to prove that there are rocketeers interested in flying it, will likely have an influence on the Board.

The first results from the June "Reader's Survey" are in, and we think we have a better idea of the type of material you would like to see in future issues of *Model Rocketry*. Once again articles tracing the history of the model rocketry proved exceptionally popular with Harry Stine's *The First Model Rockets* leading in responses. In fact, the Old Rocketeer's historical account of the early Carlisle rockets was listed on every single Reader Survey form we've received to date. Construction articles were also popular with John Belkewitch's *Thunder-Bird B/G* and Charles Andres' *Omega* series coming in second and third on your forms. Ellie Stine's article on *Paint Compatibility* was a close choice for fourth. Our coverage of scale data direct from USSR sources, the Novosti article on the "VOSTOK", ranked in fifth place, being listed on 90% of the forms. Technical articles, Doug Malewicki's *Nighthawk Wind Tunnel Data*, Forrest Mims' *Optical Telemetry*, and Tom Milkie's new tracking system, were quite popular with the 50% of the readers who listed these articles on their forms. So, unless you tell us otherwise, we'll try to increase the emphasis on historical and construction articles, while maintaining the other types of articles which proved popular. Keep the Reader Survey responses coming in!

Doug Malewicki reports that his use of 18 inch long engine pods on his boost/glid-ers is proving to be advantageous. Initially Doug used the new pod, pop-pod with the engine in the normal place but with the BT-20 length extended to 18 inches, on a new series of gliders. Recently, to see if the pod was really working, he tried it out on his 1967 vintage "Snoopy" B/G. Prior to adding the long pod the glider would frequently fly horizontally at 20 to 50 feet above the ground. With the new long pod

D - B INDUSTRIES
 BOX 2835 MANSFIELD, OHIO 44906

PRESENTS

Styrofoam wings with preshaped airfoil for Boost and Hand Launch gliders. Approximately one third the weight and tougher than balsa. Can be sanded to a very smooth finish.

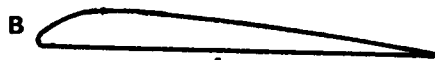

A	B	Length	Price
2"	1/8"	16"	\$.50
2 1/2"	3/16"	16"	.50
3"	1/4"	16"	.50
1/4" x 1" x 16" Strip.20

Dealer Inquiries Invited

Please ship the following:

Quantity	Size	Price	Extension
----------	------	-------	-----------

Name _____
 Address _____ .25 Handling & Shipping
 City _____ State _____ Zip _____ \$ Total enclosed
SORRY NO C.O.D.

1970 NORTHEAST TECHNICAL SYMPOSIUM

ONE DAY SYMPOSIUM ON R&D AND SCALE

TECHNIQUES TO INCLUDE:

- * 3 Seminars
- * Demonstration Launch
- * Box Lunch

TENTATIVE DATE — MID OCTOBER

TENTATIVE LOCATION — BERGEN CTY., N. J.

All those interested may send for data and application to:

Lindsay Audin, Convention Chairman

Pascack Valley Section, NAR

34 6th Street

Harrison, N. J. 07029

Doug is getting straight-up flights to about 300 feet with the same glider. The long pod adds a little weight, perhaps as much as 0.3 ounce, but it increases the reliability of the boost.

During the March 7th solar eclipse a total of 25 sounding rockets were launched from the NASA Wallops Island launching facility. Beginning at 9:30 AM with the launching of an Arcas carrying a meteorological payload and not concluding until 3:00 PM when another Arcas carried an atmospheric research payload into the sky, an assortment of sounding rockets carried specially designed payloads aloft. The largest rocket fired from Wallops on "eclipse day" was the four-stage Javelin, with an Honest John booster, Nike second and third stages, and an X248 upper stage.

A total of eight Nike-Apache sounding rockets were launched. Six Arcas, three Nike-Tomahawk, three Nike-Iroquois, two Nike-Cajun, one Aerobee 150, and one Aerobee 170 rockets also carried specially

designed eclipse payloads aloft.

The June 1970 issue of **Sky and Telescope** contains an article detailing the scientific experiments conducted. In addition it contains a photo of the Javelin launch vehicle, a view looking down the row of five Nike-Apache launchers just before launching, and an aerial shot of Launch Area 5, the northernmost of the seven launch areas, showing six Nike-Cajun and Nike-Apache vehicles on the pad. How about a "Space Systems" or "Super-Scale" entry with six operable launch pads?

Bill Harris and Bill Resnick of the Albuquerque Model Rocket Society have been working on the development of doppler shift audio tracking. The way the doppler principle works is that the frequency of the transmitted sound is shifted in proportion to the velocity difference between the source and the receiver. By measuring the frequency shift, the velocity of the source, which is attached to the rocket, can be determined. The Albuquerque group, under

the supervision of Forrest Mims, has been flying a Mallory Sonalert unit in the payload section of their test rocket. The entire unit can weigh under two ounces, and can be lofted with standard model rocket engines. After working out the "bugs" in the system, the group has been getting velocity measurements on their test rockets. On one test vehicle they report a burnout velocity of 111 ft/sec. The velocity dropped off to only 88 ft/sec one-half second after burnout. Doppler shift audio measurements look like an area which is open to considerable research. By measuring the velocity throughout the flight, and integrating it (which can be done with standard electronic circuits), the flight path length of the rocket can be determined. Anyone need a good research project?

George

Have MRm delivered to your door!

1 year subscription: \$ 6.00
2 year subscription: \$11.00

MAIL TO: Model Rocketry
Box 214
Boston, MA 02123

Name _____

Street _____

City _____

State _____

Zip _____

the journal of miniature astronautics

If you're interested in....
MODEL ROCKET TRANSMITTERS
MODEL ROCKET ELECTRONICS
SCALE MODEL ROCKETS
TECHNICAL ARTICLES
ODD-BALL DESIGNS
TRACKING SYSTEMS
FINLESS ROCKETS
PAYLOAD ROCKETS
LAUNCH SYSTEMS
CAMERA ROCKETS
BOOST-GLIDERS
RADIO-CONTROL
COMPETITION
CLUB NEWS

ANY FORM OF MODEL ROCKETRY

Then keep abreast of the latest developments.....

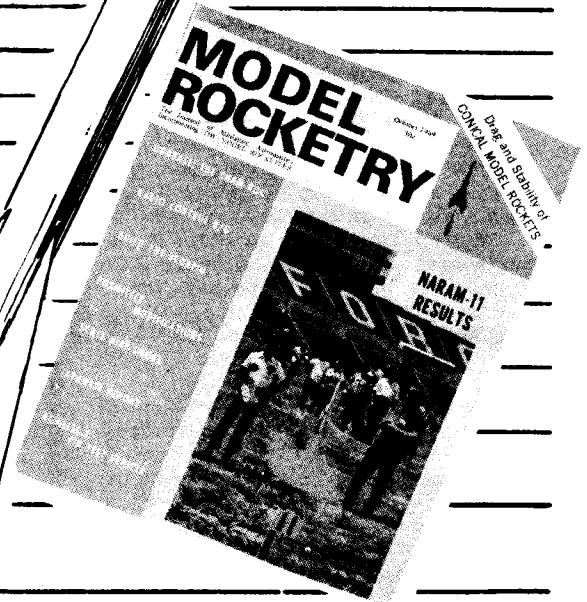

Subscribe today!

Fly the "Flop-Wing"

Variable Geometry Boost/Glider

by Bob Parks

The "flop-wing" variable geometry B/G is still in the experimental stage. Sufficient tests have been made to prove the concept workable, and it is probable that it will prove superior to the standard competition B/G now in use. There is, however, still much work to be done. (I am not saying that the front engine B/G as it presently exists has reached its maximum state of development. In fact there seems to have been a regression in performance in the last few years.)

"Flop-wing" gliders have been entered in two contests to date. The first was NART-1, where the Guppy-Bob Singer-Bob Parks team glider placed first in the Leader/Senior Hornet class. It turned in a 56 second flight. (This glider was built the night before, and the pod was actually built on the field. The first test flight was a Red Baron, while the second was the official flight. The entire glider was assembled with 5 minute Epoxy, and it took three people to put it together before the glue set.) The only other time was at WESNAM-1, the MIT section's area meet, where a B/G with an experimental pod design was flown. Needless to say, one does not enter untested experimental designs in contests (except in Condor) and expect them to work. It didn't.

When R&D was begun on this project, I

checked with Gordon Mandell and several other people about what if any work had been done on this type of B/G. I found out that apparently nothing had been done in this area. However, after a few months development, I discovered that several other people have done work with flop-wing gliders. I still have no idea what they found out, what problems they had, what problems were solved, what couldn't be solved, and what conclusions were reached. For all I know, someone may have duplicated my work several years ago. If you do some R&D, let people know about it. If you don't let anyone know what you have done then your project was nearly worthless. Even if it didn't work, you could save someone else a lot of work later.

General Background

The flight of any free flight vehicle used in duration competition can be broken down into three parts. First, is the ascent stage (boost) during which the highest possible altitude is gained. Second, the transition between the climb and glide phases. Finally, a gliding stage, in which the minimum possible sink rate is desired.

If one omits either the climb or the glide (and thus, the transition) from the flight, it

is very easy to design the "ultimate" vehicle. For boost, the typical altitude model would be near optimum. The best gliders (from the point of minimum sink rate) would resemble the indoor microfilm glider. These are built up frameworks covered with a very thin layer of plastic. A 50 square inch glider would weigh well under 1 gram! Sink rates of under a few inches per second are easily attained. Of course one must consider the entire flight. Altitude models don't glide very well, and a microfilm glider would disintegrate at speeds of over a few feet per second. Tradeoffs between boost and glide must be made to obtain a workable vehicle.

It might be helpful to look at model airplanes that have flight problems similar to a B/G. There are two types, outdoor hand launch gliders (HLG), and engine powered free flight models. Since most B/G's resemble hand launch gliders, let's examine them first. (Doug Malewicki's R/C B/G described in the August '69 Model Rocketry is derived from a HLG.) Somebody with a good arm can throw one to altitudes of over 60 feet. Although I have no accurate figures, a maximum velocity on the order of 100 fps would seem reasonable. That works out to accelerations of over 25 g's during the throw. Glide sink rate is about 1 fps. At first glance, it looks very similar to what a B/G

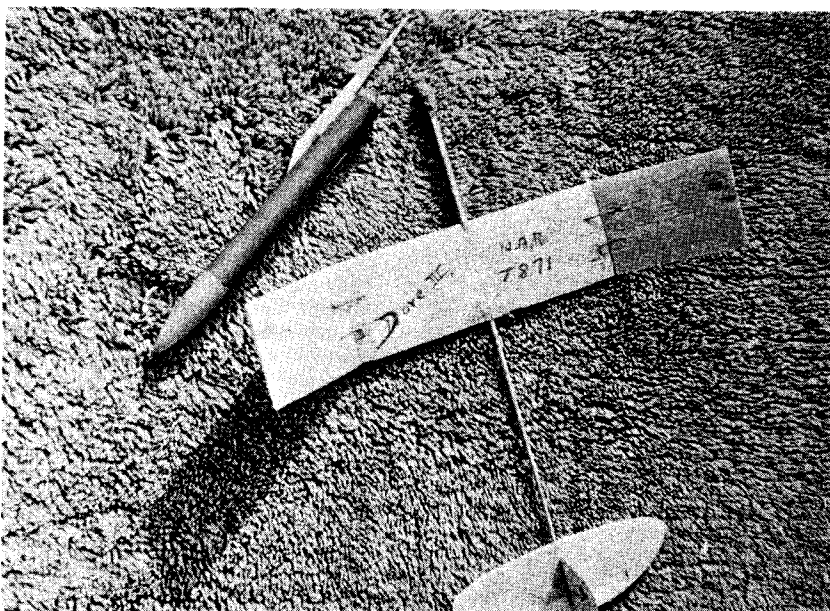
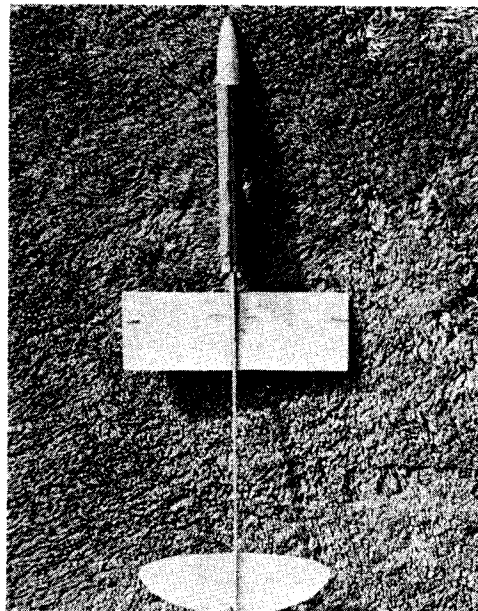

An A-engine Dove III type flop-wing shown in both boost (left) and glide (right) configurations. The design includes a simple auto-elevator. A construction article will be presented next month.

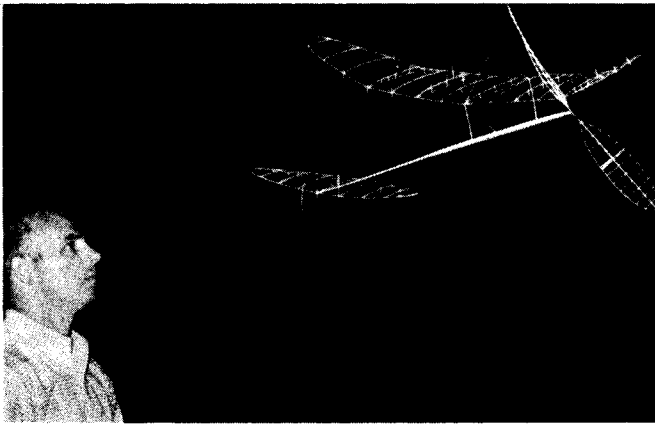

This rubber powered indoor model shows the type of construction that would be used on a microfilm glider. Flight speeds are under one foot per second. These models can turn in flights of over 20 minutes in a gymnasium. (For more information on indoor modeling write to the NIMAS, Box 545R, Richardson, Texas.)

encounters. Most HLG's are set up with the stabilizer at 0° angle of attack in relation to the wing (0° decalage). This results in a low slope of the pitching moment curve. (Basically a pitching moment curve is a graph of the pitch rotational forces plotted against angle of attack. The glider will fly at the angle of attack where the rotational forces are zero unless disturbed by turbulence. If the glider is displaced from this angle of attack, the pitch rotational forces tend to force it back. The greater the slope of the pitching moment curve, the more restoring force will exist for a given displacement. A low slope is not really a problem (within limits) once the glider is in a stable glide. However, a low slope will generally *increase* the amount of altitude lost in the transition, and can cause death dives. For a more complete explanation of pitching moments see Doug Malewicki's May '70 article in *MRm*. For a more technical treatment see Frank Zaic's book *Circular Airflow*.) Why don't HLG's have a transition problem? Well, as anyone who is experienced with HLG's could tell you, the

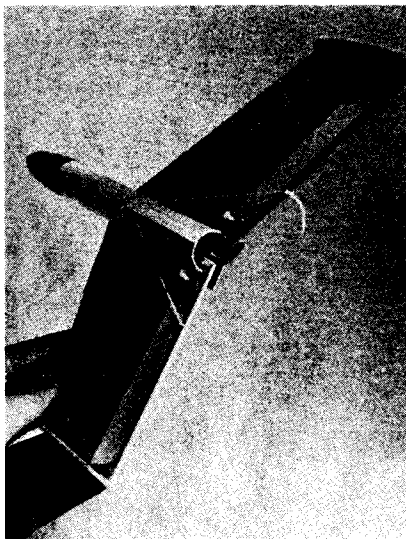

A rear engine B/G. Note the elevons that are released at ejection for glide stability.

method with which the glider is thrown has a lot to do with the transition. When thrown properly, the glider will finish its climb at nearly the proper speed and angle of attack to glide. It appears that "ye olde HLG" is *not* necessarily the best design for a B/G.

Now, what about the power free flight? These are generally limited to about a ten second engine run, they climb nearly vertically at speeds of 60 to 80 fps and also have a sink rate on the order of 1 fps. The method of launching has almost no effect on the transition. Also, as on a B/G it is possible to make adjustments separately to power and glide trim. This seems much closer to a B/G. On a power free flight, the stabilizer is generally at an angle of attack of about 2° lower than the wing (2° decalage). This results in a much better pitching moment slope than the HLG. Powered flight is adjusted by changing the thrust line of the engine.

Of course, neither the HLG or the power free flight is a B/G. Boost gliders encounter much greater velocities and cannot use wing lift during the climb as model airplanes do. However, the previous discussion will prove to be helpful.

The first type of B/G to be developed was the rear engine type. Some examples of this type are the Estes Space Plane and the old Centuri Aero-Bat. Rear engine B/G's were generally flying wings or deltas. Transition was accomplished by releasing elevons at the time of engine ejection. The elevons were pulled upwards by elastic to about 10° degrees. This greatly increased the pitching moment slope, and thus affected transition. These gliders would almost always transition properly. However, the sink rate of these gliders left something to be desired.

Next came the front engine B/G. This type was developed by Larry Renger and won the first Estes B/G design contest in 1963. The glider (Sky Slash II) was basically a swept wing HLG with a fixed forward pod. These gliders had a low pitching moment slope, which, although it allowed a reasonably straight boost, made transition a rather tricky thing. The first front engine B/G's would often death dive. It is possible to rotate either the entire stabilizer, or an

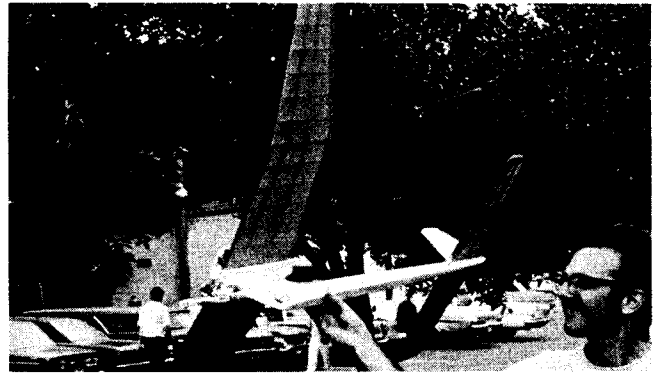

A high performance powered free flight, wing span of 48 inches, with a 0,049 cu. in. engine and weight of about 9 ounces seems to offer the best aeromodeling analogy to the boost/glider. For contest use the engine run is limited to 10 seconds and the models climb nearly vertically under power. Flight times are on the order of three minutes, though flights of over 8 hours and over 100 miles have occurred.

elevator to a slight negative angle of attack (up elevator) when the engine ejects. This will result in a steeper pitching moment slope, thus improving the transition. (I believe that Renger's original Sky Slash had such an auto-elevator. It was removed by Estes when they redesigned the glider to simplify building.) The pop-pod was later added to this type of glider.

The remaining type of B/G is the variable geometry. At first glance this would seem to be the way to go. By using variable geometry it should be possible to have a vehicle that resembles a normal rocket during boost and a good glider for the descent, thus approaching the optimum for both phases. Transition should be effected by the change in shape of the vehicle at ejection. The main disadvantage is the added mechanical complexity.

The first general type of variable geometry B/G is the flexwing. These are further divided into two groups. Extensible flexwings have wings that are pulled out of the body and elevators that are pop up at ejection. This type of glider was developed for

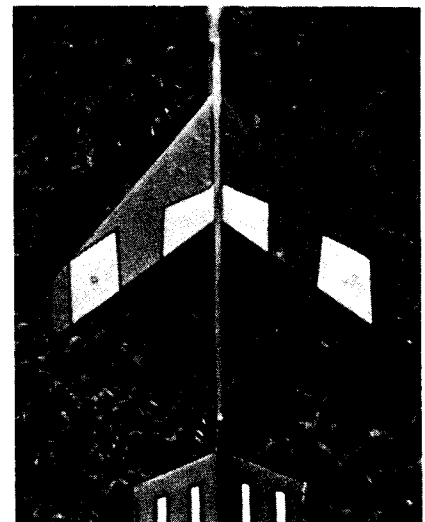

A front-engine B/G similar to the Sky-Slash in appearance. Other front engine B/G's use less wing sweep and/or pop-pods.

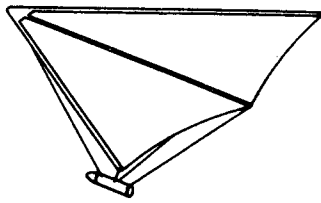

An ejectable flexwing. The complete glider is ejected from a "normal" rocket. These types of gliders have very low wing loadings, but poor spiral stability.

use in recovering payloads. The other type is the ejectable flexwing. In this configuration, an entire Rogallo wing type glider is carried aloft inside a normal rocket and ejected at apex. At the moment, flexwings have a few problems for use in competition. First, they have rather poor roll stability, and tend to spiral easily. Second, the flexible wings tend to have rather poor efficiency. However, it is possible to build an ejectable flexwing with a fantastically low wing loading, which gives good durations.

The second type of variable geometry B/G uses a rigid wing and a mechanical pivot. The oldest glider of this classification is the "swing wing." In these gliders the wings are pivoted near the body and swing back during boost. This reduces frontal area and thus drag. It also decreases the chances of a wing structural failure during boost. The main disadvantage is the additional weight of the pivots. On a large glider this should not be too bad.

The other type of rigid wing variable geometry B/G is the "flop-wing." The concept is rather simple. There is a hinge at the wings' outer polyhedral joint. During boost the tip panels fold down and under, and fit against the center panels. This halves the wing area during boost, thus reducing drag, forming a symmetrical airfoil, and increasing the strength of the wing. One of the other advantages is the light weight of the pivot and extension mechanism. (Someone is building a large flop-swing wing glider. I have no idea as to how this will turn out. It is possible that only the disadvantages of the two systems will result, however, if the advantages are combined, it could be pretty good.)

At the moment I have no idea as to the boost configuration drag reduction of either the flop-wing or the swing wing. If the boundary layer remains attached over the wing on a flop-wing then the pressure drag becomes very small. The friction drag is the other major component of the total drag, and it is greatly reduced because of the reduction of wing area. However, if the boundary layer cannot be kept attached, then the swing wing's reduction in frontal area is more important. One of the problems in determining the drag is that it depends greatly on the type of construction. This is one area where someone who does not have an extensive scientific background can perform useful R&D. At the moment, it

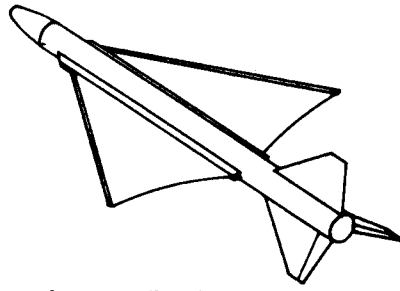

An extensible flexwing in glide condition. This type of glider has flexible wings that are extended from the body for glide. These gliders tend to be more stable than ejectable flexwings, but also have much higher wing loadings. Note auto-elevators.

appears that the flop-wing is superior in at least the smaller engine sizes. A well constructed flop-wing should be capable of beating the normal HLG type of B/G (assuming equivalent air conditions for both and that both are recovered). A flop-wing can be boosted higher, and can be built somewhat lighter than a normal B/G.

FLOPWING DESIGN CONSIDERATIONS

General Proportions

To date, almost all test models have used Dr. Gregorek's Basic Boost Glider proportions (these were outlined briefly in the Pittsburgh Convention article in June '70 MRm). I see no reason to depart from these proportions for small B/G's.

The following sizes seem to be about right; Hornet, 20-25 sq. in.; Sparrow, 30-36 sq. in.; Swift, 40-50 sq. in.; Hawk, 50-75 sq. in.; Eagle, 80-160 sq. in.; Condor, 160-500 sq. in. These sizes will work, although they may not be optimum. I am beginning to experiment with a 15 sq. in. Gnat class glider (Hornet flown with a 1/4A engine limit) for an MIT section mini-meet in September.

Wing

The airfoil used should have a completely flat bottom. The leading edge should *not* be rounded. This is to improve the airfoil during boost. Doing this makes almost no difference in the glide. Undercambered airfoils are definitely superior during glide. If the airfoils are too thick when folded, then boundary layer separation is bound to occur. It would be worthwhile to experiment with airfoils that would result in a laminar flow section when folded.

To date I have only used rectangular planforms. This is definitely not as efficient as an elliptical wing during glide, however I feel that the advantages during boost are more important. I must emphasize that I have no data on this.

Wings can of course be built by the standard solid balsa sanded to an airfoil. There are other construction methods that can result in stronger lighter wings. First, there is the composite wing as used on Doug

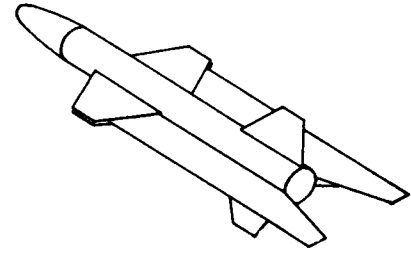

A swing-wing B/G in boost condition. During glide the wings swing forward. Swing-wing gliders have also been constructed using forward mounted pop-pods.

Malewicki's R/C B/G (Sept 1969 MRm). I have found that a thin coat of epoxy paint applied to the wing will help prevent warps and strengthen the wing, especially thin trailing edges. Clear epoxy is the lightest, however, Hobbypoxy's Fluorescent orange greatly improves visibility without adding much weight. An alternative is to use ultra light balsa and cover it with light weight model airplane tissue and dope. This takes some practice but results in a strong, light wing. Built up wings can also be used, in fact they are almost mandatory on larger gliders. I have built some Hornet gliders with built up wings. They were about 24 square inches and weighed about 4 or 5 grams in glide condition. I do not recommend tissue covering on built up wings. Super Monokote or silk should be used. Adhesive backed aluminumized Mylar can be used like Monokote, and can be heat shrunk, although care is needed in determining the proper iron temperature. I have not yet tried a styrofoam flop-wing. Results on other B/G's that I have seen appear promising, and I intend to try it in the future.

On small gliders, hinges are no problem. All of my models have used Super Monokote or adhesive backed Mylar applied over the joint between the panels. It should be applied to the bottom of the airfoil. Tissue hinges have been tried, however they tend to tear easily. Tape can be used but it is not really satisfactory. Dihedral can be adjusted by carefully sanding an angle on one of the

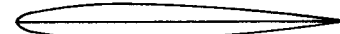

FLAT BOTTOMED

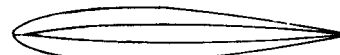

UNDERCAMBERED

7-70

®

Typical flop-wing airfoils. Note the shape of the leading edge. The airfoils are shown in the folded configuration.

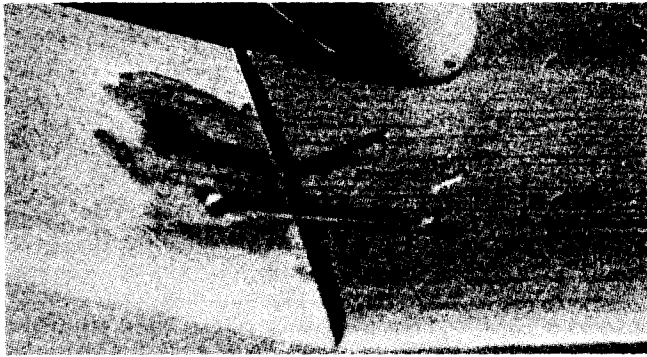

Hinge area of a partially unfolded wing. Note the wire stop and the elastic. Super Monokote hinge is used on the bottom of the wing.

panels, this is tricky to do. A better way is to epoxy a thin wire stop to the wing. Dihedral is then adjusted by bending the wire. Hinges for undercambered wings are somewhat more complex. A piece of thin plywood (1/32") is glued to the end of each panel. This is trimmed flush with the upper surface of the airfoil. The bottom is cut in a straight line from the leading edge to the trailing edge (this line is where the bottom surface of the wing would be if a flat bottomed airfoil were used). Care should be taken when hinging the tips so that the tip panel matches exactly with the center panel when folded. There should not be any sweep forward or sweepback in the tips when unfolded.

Wings are unfolded by elastic or rubber as shown in the photos. Pieces of rubber bands should suffice on smaller gliders, 1/8" shock cord is about right for large gliders. On flat bottom wings there is a problem in that the rubber cannot protrude from the bottom of the wing, or else the wings will not be able to fold up completely. I have been using the following method of attaching the rubber. First drill a hole in the wing about 1/2" to 1" from the hinge. The hole should be drilled in both panels, and should be slightly larger than the size of the rubber. The rubber is then put through the hole and 5 minute epoxy is used to fill the rest of the hole. After the epoxy hardens, the rubber is put through the hole in the other panel, stretched slightly and epoxy is applied as before. After the glue hardens, a razor blade is used to trim the rubber and epoxy on the bottom of the wing. It is not necessary to have the wings deploy quickly. The wings will tend to deploy themselves when in the air. Too much rubber will tear the hinges. A good test is to take the glider after it is trimmed to glide and fold the wings, then hold it on the bottom of the body (thus holding the wings folded) and give it a gentle toss. The wings should unfold and it should begin to glide before it hits the ground.

Fuselage

For small gliders, spruce is definitely the best material for fuselages. Hard, springy balsa is next best.

Static strength is not really required, flexibility is much more important. To get

the required flexibility, use a piece of wood that has no imperfections or weak spots. The grain should run perfectly parallel to the sides of the wood. There should be no warps. The shape of the tail boom is also very important. It should have an *oval* cross section, and taper linearly in both the top and side views. It takes some practice to make these booms properly, however it is well worth it. I have pranged gliders with balsa booms from several hundred feet onto asphalt, and *not* broken the boom. In fact, a properly built boom will bounce! Care should be taken to keep from making the boom too small as this could cause flutter problems during boost.

On larger gliders, spruce can also be used. Fiberglass tubes, such as arrow shafts or fishing rods also work very nicely.

Stabilizer and Rudder

Very little needs to be said about stabs and rudders. They should be built strong enough to prevent flutter. Built up stabilizers can be helpful on larger models. They should be built as light as possible. On a free flight glider, the stab should be tilted about 5 to 10 degrees in relation to the wing from the front view. This will result in a gliding turn without affecting the boost. An auto elevator is helpful and worth the extra work. A simple auto elevator will be presented next month.

Pods

The difficulties of actuating the wings with a normal type of pod has resulted in an investigation of pod locations and attachment methods.

Near the beginning of this project, I did some calculations to find out how the CP location was affected by folding the wings. As it turned out, the CP was about 1/2 the chord width behind the trailing edge of the wing. If I would have used a normal pod location, it would have resulted in a CP-CG separation of over 2" on a 10" span glider. A "Midi-Pod" was designed that would fit on just behind the wing and would hold the wing closed when in place. CP-CG separation was now about 3/4", normal for a regular rocket of the same size. The glider was flown with a 1/2A. As soon as it left the rod,

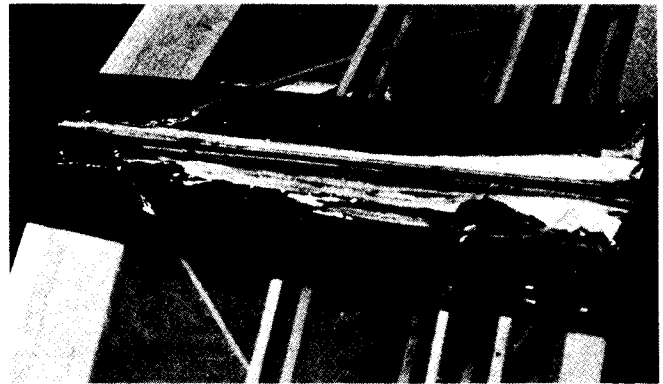

Hinge area of an undercambered wing as seen from the bottom. Note the use of hinge plates.

it began a tight (10 foot radius) pitch down loop, which continued until burnout. After burnout, the glider went perfectly straight until ejection. A later calculation showed that without aerodynamic forces, a typical B/G would be rotating in pitch at over 20 revolutions per second. This is due to the off center thrust of the engine. Considering that most B/G's boost reasonably straight up, aerodynamic forces must counteract the offset thrust. The following explanation has been worked out and seems to be accurate. As the B/G leaves the rod, it begins to pitch down. As the angle of attack increases, the stabilizer begins to produce lift which results in a pitch up force. (I am ignoring any effects of the wing at this time because of its short moment arm about the CG in pitch.) Eventually an angle of attack is reached where the stabilizer life exactly balances the engine's pitch down force. At this angle of attack the stabilizer has a force in the downward direction, and the engine also has a component of its thrust in the same direction. This causes the glider to translate downwards. This movement, when combined with the forward velocity of the glider results in a new angled flight path. This has the effect of reducing the angle of attack on the stabilizer, thus allowing the engine to pitch the B/G down even more, etc. The final result is an outside loop. This loop is much larger than if the aerodynamic forces were not present. There is one more

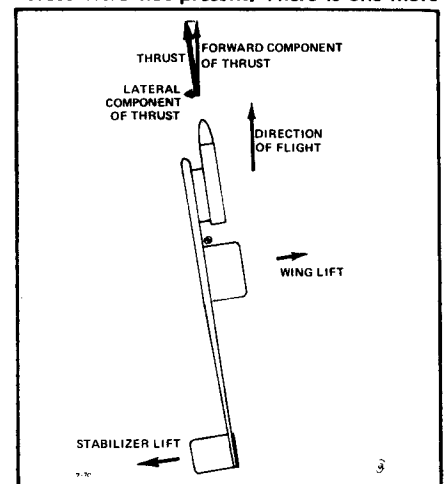

Forces acting on a front-engine B/G during boost.

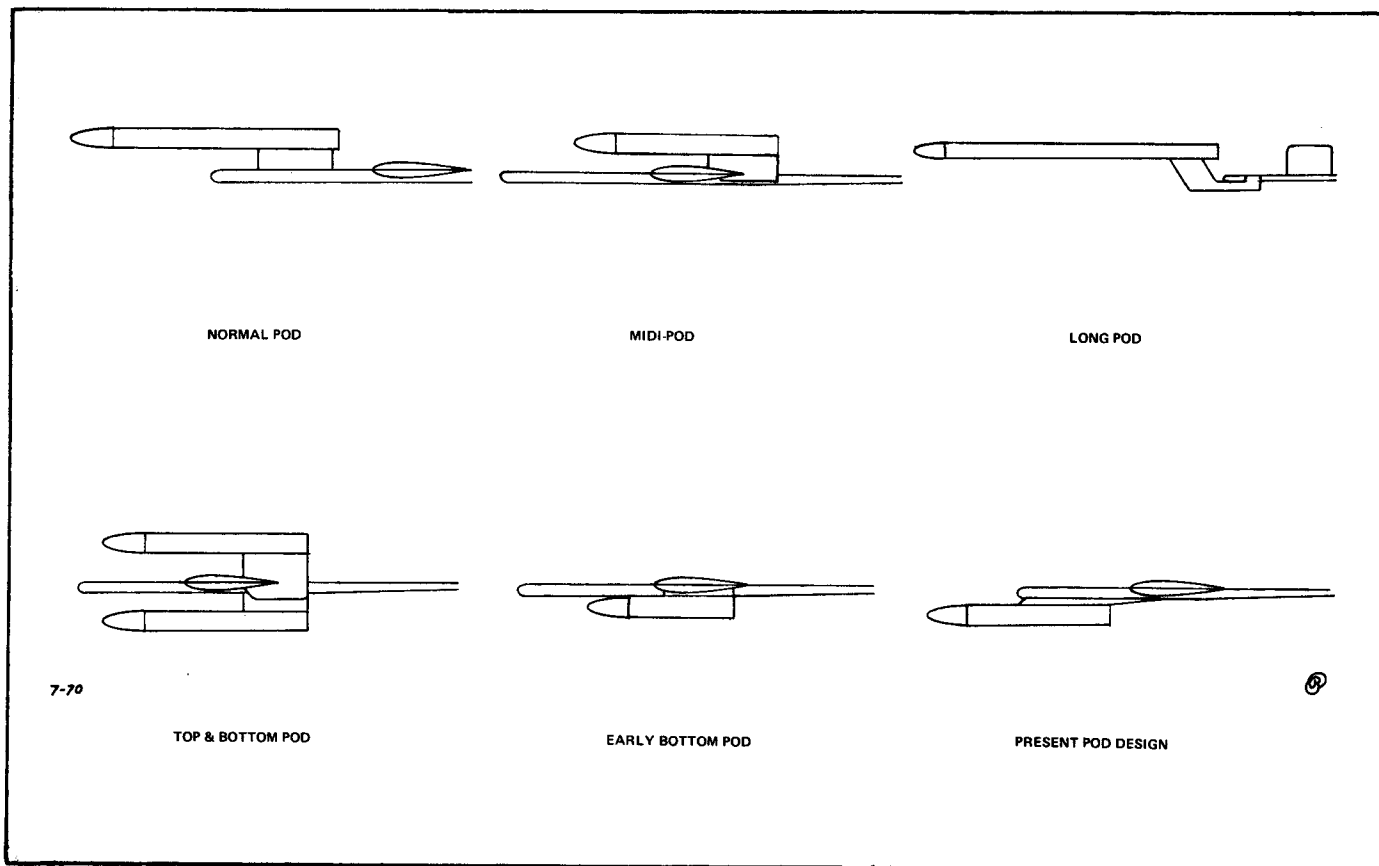

The various pod configurations tested.

force to consider, the wing lift. Most common B/G airfoils will still produce lift in the upwards direction at slight negative angles of attack. This lift will help to prevent the downwards translation and thus the loop. It is possible to trim the B/G to boost straight up by balancing these forces, but lift means that drag is being produced, so such a boost is not very efficient.

The situation can be improved in two ways, decrease the drag involved in producing a given corrective force and reduce the engines pitching force.

The effects of the engine can be reduced by increasing the longitudinal moment of inertia or by eliminating or reducing the thrust line offset.

Stabilizer effects can be increased by increasing the moment arm or using a stabilizer that will produce sufficient corrective force at a lower angle of attack. (This is done by using a lifting airfoil or setting the stabilizer at a negative angle of attack in relation to the rest of the glider. An auto elevator can be used to adjust the stabilizer angle of attack for boost and for glide separately.)

The only ways that the tail moment arm can be increased are to use a longer tail boom or to shift the boost CG forward. Increasing the tail boom length is not really desirable because it also affects the glide trim. Moving the CG forward will tend to increase the tendency to weathercock. Adjusting the stabilizer incidence is tricky but will work. A major problem with using aerodynamic forces to balance the thrust forces is that thrust and velocity vary

independently. This means that the B/G will not really go straight up, but in an S curve as first the thrust forces and then the aerodynamic forces dominate. Increasing the moment of inertia generally means adding weight or size, both of which are undesirable. (Doug Malewicki has had good results with pods using an 18" body tube. This increases the moment of inertia and shifts the CG forwards. It also moves the CG closer to the thrust line of the engine. Doug reports that these pods are putting gliders up higher than normal.)

It would of course be ideal to have the thrust line on the center line of the model. This is not possible on a front engine B/G. It is possible to use an engine on top of the glider and one on the bottom, thus placing the effective thrust line on the center line of the glider. However the pod system involved is complicated, heavy and has lower reliability because of the cluster ignition. The only other thing to do is to reduce the pylon height. It seems that pylon heights were standardized back when the old English system engines were in use. These engines had overexpanded nozzles and rather wide exhaust plumes. High pylons were needed to keep the tail from being burned off. However, the new engines have much better nozzles and a very narrow exhaust plume. Tests have shown that in some cases no pylon at all is required. Engines have been placed directly on the bottom of the boom and there was no evidence of charring at all.

The final pod design has the engine located in about the normal fore and aft position with a normal length pod. How-

ever, the engine is located on the bottom of the body with only a very low pylon. The bottom location is to simplify holding the wings closed. The low pylon is only for ease of construction.

I have been using a pin pod, however a piece-X pod could also be used. The shock cord should be attached to the outside of the body tube near the back on the side away from the glider. This causes the parachute to swing out and away from the glider at ejection. Also, if the pod fails to come off at ejection there is still a chance that the parachute opening shock will pull it off.

There is one final problem. A reasonably well built conventional B/G is capable of getting lost in even a slight wind. Therefore, there isn't much sense in building a better glider. However, we can take another idea from model airplanes and use a dethermalizer. Basically a dethermalizer (DT) is a device that changes the trim of the glider after a certain amount of flight time, thus bringing it down quickly. The use of DT's allows flight testing without fear of losing the glider. In contests the DT can be set to being the glider down after the longest flight that you feel will keep the glider within recovery range.

Next month there will be plans for a Sparrow flop-wing with an auto elevator and a DT. Later there will be plans for a large R/C flop-wing using a built up wing.

I am interested in hearing from anyone who tries a flop wing B/G. I will attempt to answer any questions that are accompanied by a self-addressed stamped envelope, c/o Model Rocketry.

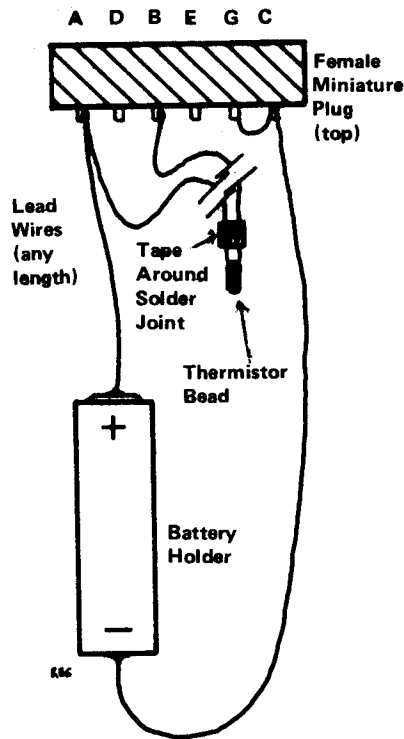

Figure 1: Temperature Sensor Wiring Diagram.

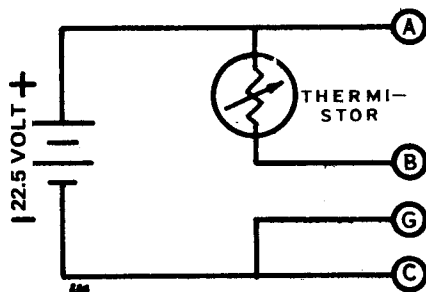

Figure 2: Sensor Schematic Diagram.

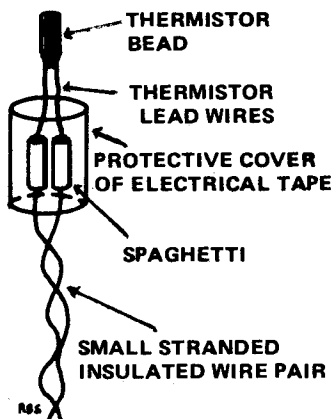

Figure 3: Details of Construction of Thermistor Bead Mount. The small stranded wire is of the type used on cheap imported earphones. The spaghetti is the electrical variety. It is simply hollow tubing which is used to cover the solder joints between the thermistor leads and the stranded wire.

An improved Temperature Sensor for your Foxmitter II

by Richard Fox

Construction

The temperature sensor module is designed to plug into the Foxmitter II transmitter described in the July 1970 issue of this magazine. Figure 1 shows a pictorial of the circuit wiring. Figure 2 shows a schematic diagram of the circuit, and Figure 3 shows details of the mounting of the thermistor bead. Needless to say, use care in handling and soldering the bead. Excess heat may cause damage to the thermistor.

Calibration

The thermistor used in the temperature sensor has a negative temperature coefficient. In other words its resistance drops as its temperature increases. This effect is used in the Foxmitter to control the audio frequency produced by the relaxation oscillator. As the temperature rises, the sensor resistance falls, and this causes the tone produced by the oscillator to rise. The transmitter sends this tone to the ground over the 27 m.c. Citizens Band. The signal is received by a walkie-talkie or C.B. radio, and the audio tone can then be tape recorded for later study.

The circuit which converts the thermistor resistance to an audio tone was designed to minimize parts and cost, not for maximum linearity. As a result, the temperature sensor-transmitter combination must be calibrated *before each flight*. Two calibration points are sufficient if the unit is assumed to be linear over small changes in temperature. Figure 4 shows a typical variation of thermistor resistance with temperature. The plot indicates that the device is not linear over large ranges of

Foxmitter Error

An error appeared in Figures 1 and 2 of the Foxmitter II article in the June 1970 issue. In Figure 1 the pins on the miniature connector should read from left to right A,D,B,E,G,C, and in Figure 2 they should read from left to right C,G,E,B,D,A. We regret any inconvenience this typographical error may have caused our readers. The wiring as indicated in the schematic diagram is correct.

In the June 1969 issue of *Model Rocketry I* described how to build a temperature sensing module for the Foxmitter I model rocket transmitter. The article described the electronics involved, and the procedure for calibrating the tones. It also suggested some experiments for a rocket equipped with temperature sensor telemetry. However, the article did not present much in-flight data. This lack was the result of trying to design and flight test a series of 5 sensor modules for the transmitter before the weather became too cold. This objective did not leave much room for experiments using the sensors.

The situation changed when in the spring of 1970 I observed the flight of Richard Brandon's temperature sensor Foxmitter at the Pittsburgh Spring Convention, and . . . wow! The recording of the flight clearly showed a *sharp drop* in the measured air temperature during the thrust phase, a gradual decline in temperature during the coast, a sharp rise and rapid fall in temperature at ejection, and a gradual rise in temperature as the rocket fell back to earth.

The sensor had recorded an unexpected series of phenomena which needed explaining. Was the sharp drop in temperature due to the wind rushing past the sensor? That theory implied a convective cooling which was stronger than the frictional heating of the sensor. What about the rise and fall of the temperature at ejection? The ejection gases must have swooshed past the sensor! And just how much colder was it up there anyway?

Marvin Liebermann of the Steel City Section was intrigued by these questions, and is now conducting a number of flights, using the Foxmitter II temperature sensor.

These early flights prompted further development of the temperature sensor, and resulted in this temperature sensor for the Foxmitter II. It contains several improvements over the original version, of which the most important are a much *faster response* to changes in temperature, and *increased sensitivity*. It will sense the heat of your hand from a half inch away! The cost of the improved sensitivity and response is increased delicacy. The sensor is a tiny black thermistor bead about 1/16 inch in diameter, with two tiny wires protruding from it. However, all of the units tested have survived crashes due to parachute failure.

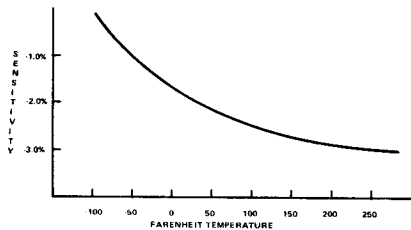

Figure 4: Sensitivity of Typical Thermistor Material.

temperature, but that over small ranges of temperature it is so close to linear, that an assumption of linear response will not introduce appreciable error.

In the field, the two most convenient calibration points are the air temperature, as indicated by a thermometer, and the temperature of the tip of your tongue, between 98 and 99 degrees F. To calibrate the sensor, tape record the tone produced by touching your tongue to the thermistor

Thermistor

Female miniature connector

Battery Holder

Temperature Sensor Parts List

**Veco model 51A2
100K OHMS at 25°C**

**R/C Craft connector model
#19K61, 6 pin
\$.49 from Ace R/C, Higginsville
Mo. add \$.50 for handling**

**Keystone #50053 available
from Lafayette as #34E50053**

A complete kit of parts for this sensor module is available from Astro-Communications 3 Coleridge Place, Pittsburgh, Pa. 15201, for \$3.00 postpaid.

bead, and the tone produced by the air temperature. Do not let your tongue touch the wires leading to the bead because your tongue will short the wires, thereby providing a false reading. Besides, you will get a very slight shock. (It does not hurt.)

Once the two calibration points are recorded, the transmitter is ready for flight. Tape the sensor bead to some convenient part of the outside of the rocket. The spot where the parachute will eject provides

interesting data because of the hot ejection gases passing by the sensor. The side of the engine will show you how hot the engine gets, and the side of the lifting vehicle, near the engine nozzle, will provide data on the temperature of the exhaust cloud at lift-off.

Early results from Marvin Liebermann's flights have raised more questions than they answered. Each flight had its own variations in the data. How about some additional in-flight data from our readers?

New Product Notes

Pettit Paint Company, makers of Hobby-poxy model paints, has recently announced several products of special interest to rocketeers. First is Formula IV "Quick Fix" epoxy. This glue sets in 5 minutes, and reaches full strength in 15 minutes. It should be perfect for super-strong construction as well as rushed on-the-field repairs. Glo Paint Orange, the newest color in their epoxy enamel line, combines the visibility of a fluorescent paint with the gloss and strength of epoxy paint.

Also available is a free booklet on the "Easy-Does-It" filler method, which produces a smooth hard surface on balsa nose cones with a minimum of effort. For more information on the "Easy-Does-It" method as well as other Hobbypoxy products write: Hobbypoxy Products, 507R Main St., Belleville, New Jersey 07109.

Rocket Equipment Co. has announced the first in a series of 35mm color transparencies of rockets and missiles. These photos

have been specifically selected for their usefulness as color substantiation data for static and flying scale model rocket construction.

The first series of slides is of the USSR "VOSTOK" launch vehicle. Five photos of the actual launch vehicle clearly show the green paint color of the airframe and the white frost surrounding the lower two-thirds of the "VOSTOK." Details of the large hold-down arms, launch tower, and pad area are also shown in full color in the five slide liftoff sequence. A rear view of the full size display model (in Moscow) shows the 20 exhaust nozzles of the Russian vehicle. These photos may be used as a painting guide for the new MPC "VOSTOK" plastic model kit. All six color transparencies are taken from official USSR movies and stills. They are priced at \$1.00 each, or all six for \$5.00 (postpaid).

REC will soon expand its line of 35mm color transparencies to include US, Canadian and other space boosters and sounding rockets commonly modeled by rocketeers or available in kit form. Complete, up-to-date lists of available slides may be obtained by sending a self-addressed, stamped envelope to Rocket Equipment Co., 10 Mulberry Ave., Garden City, New York 11530.

Plastruct, Inc., makers and suppliers of plastic scale model structural shapes and parts, has developed a new cement, Plastic Weld, for bonding their materials. It also works for a variety of other plastics such as Styrene and acrylics (Lucite or Plexiglass).

The method of cementing or bonding plastic parts together is most similar to a weld. Parts to be cemented are held together, the solvent is applied to the joint in usually one place, and through capillary action it will travel the length and breadth of the joint to form an almost instant weld.

Plastic Weld actually dissolves a thin layer of each piece at the area to be joined. The solvent evaporates quickly, leaving two pieces welded together with a joint as strong as the plastic parts themselves. A small brush or blunted syringe is recommended for applying the cement. The result is not only neater than other methods, but is also stronger and faster. Ingredients in Plastic Weld are the finest obtainable and is the same cement industrial model makers have found best for their extensive applications.

The 2-oz. container of Plastic Weld is listed in the new 1970 Plastruct catalog and retails for 59¢. To order write Plastruct, Inc., 1621 N. Indiana Street, Dept. MR, Los Angeles, Calif. 90063.

A starter set for novice model rockets, containing everything needed to launch a model rocket safely, is available from Model Products Corporation, Mt. Clemens, Mich. The set, which comes packaged in a reusable corrugated carrying box with a plastic handle, contains an MPC rocket launch pad, a launch controller, a Pioneer 1 plastic rocket, two MPC A3-2 rocket engines and a comprehensive instruction sheet.

The MPC rocket launch pad features a ceramic exhaust deflector to eliminate short-outs, a tilt-leg adjustment to alter flight direction, a wind direction indicator, an adjustable launch lug and snap-in electrical terminals. The launch pad is of sturdy tripod design. The launch controller has a pistol grip for sure handling, a safety key, a continuity light to assure a complete circuit, a 15 foot firing line, a 10 foot power cord and a recessed push button to prevent accidental launchings. MPC's Pioneer 1 is a single stage, high-performance rocket featuring molded fluorescent plastic swept fin assembly and nose cone, a fiber tube body, an engine mount and a full color decal. The instruction sheet provided with MPC's Flying Model Rocket Starter Set includes a complete explanation of flying model rocketry, the safety code, suggested beginner projects and construction diagrams.

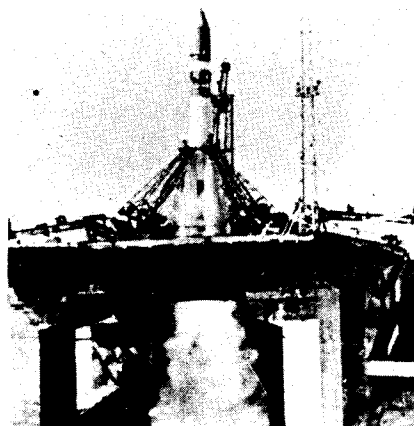

REC "VOSTOK" Ignition Photo

If you were born after 1948,

you're in luck.

If you're under 22, you can join the TWA Youth Club.

Which means that everytime you fly with us in the continental U.S., you'll get 40% off regular coach fares, on a standby basis.

If we don't fly where you want to go (and we fly to 42 cities around the country), just take another airline. You can still use our Youth Club Card.

You can also use your card for discounts at the Hilton and Sheraton

Hotels.*

All of which means our Youth Club Card can save you loads of money. Which isn't bad for a \$3.00 card.

Just mail in your application with all the correct information, and don't worry about it.

Your application won't be rejected.

TWA

TWA YOUTH CLUB
IDENTIFICATION CARD APPLICATION
FOR AGES 12 thru 21

Please Print

1. Name _____

2. Address _____

City _____ State _____ Zip Code _____

3. Male Female 4. Hair Color _____ 5. Eye Color _____

6. Date of Birth _____

Month Day Year

7. Fee enclosed: \$3.00 Check \$3.00 Money Order
Make checks payable to: TWA
(Not refundable — DO NOT MAIL CASH)

8. Signature _____

Mail to: Trans World Airlines
P.O. Box 2952
Clinton, Iowa 52732

1	—	067	—	6	—	2	0	3	3	9
---	---	-----	---	---	---	---	---	---	---	---

TRAVEL RESTRICTED ON CERTAIN HOLIDAY PERIODS

*in continental U.S. only.

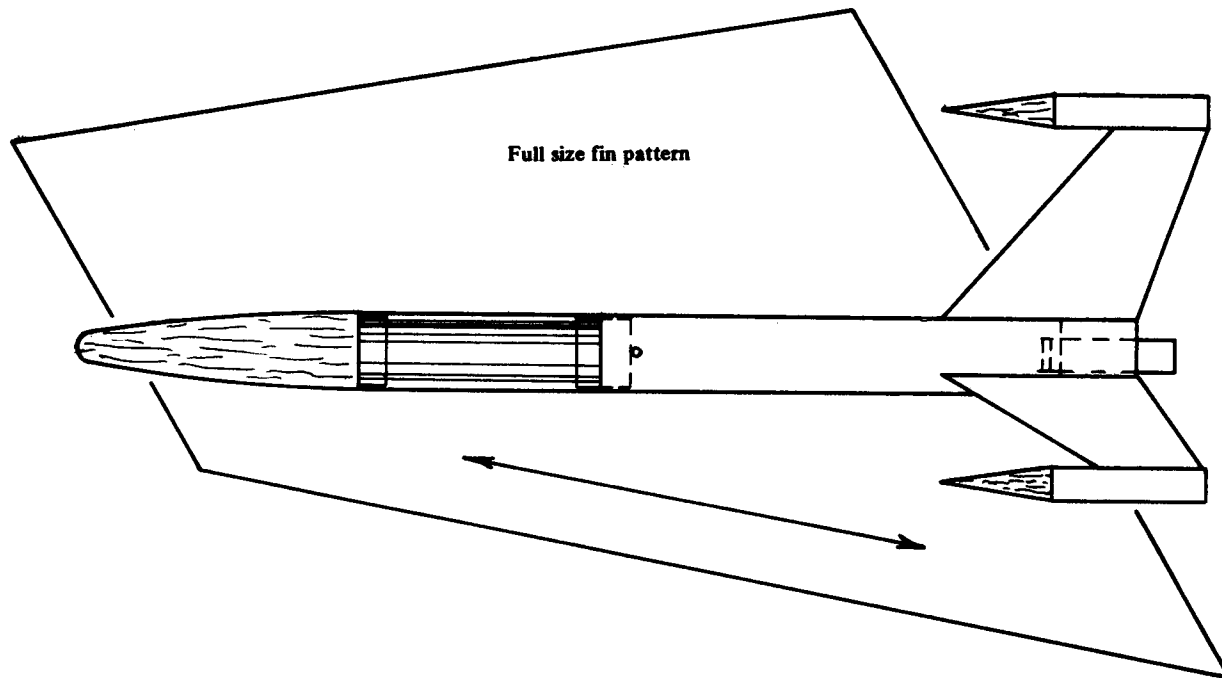

Build the EFA Payloader

RANDY BLACK describes an unusual dual purpose model, the EFA Payloader. When flown with only a core engine this futuristic design is ideal for demonstration launches. Adding engines to the fin pods turns the EFA Payloader into a high-altitude payload rocket with a 6 ounce capability.



The EFA Payloader being prepared for flight. Even with only a single engine, this futuristic design will attract attention at your next demonstration launch.

The EFA Payloader is recommended for modelers who have some experience in cluster ignition. It has been flown with only a single B4-2 or a C6-3 engine as a demonstration rocket, and with three additional engines in the power pods as a high performance rocket which may carry up to six ounces of payload.

Start construction by tracing the fin pattern onto heavy typing paper. After tracing the pattern on $\frac{1}{4}$ inch balsa stock, cut out three fins and round the leading and trailing edges.

Select one of the four BT-20J tubes and glue the engine block so that it is flush with the end of the tube. Glue the two 2060 rings on the 60C coupler and let this assembly dry completely. Now glue the engine holder tube so that the end with the engine block projects $\frac{3}{8}$ inch from the 2060 ring. Run fillets around the ring-tube joints and glue it into the main body tube so that the 2060 ring is flush with the rear of the body tube.

Glue each BNC-20R nose cone into one end of each BT-20J tube. Attach the three fins and launch lug to the body tube. Now glue the three power pods to the end of each fin and apply fillets to all fin-tube joints. Glue the screw eye into the balsa adapter and insert into one end of the PST-60R payload tube. Assemble the shock

cord mount and glue inside the main body tube and place a snap swivel on the other end. Assemble the parachute and finish the model in the usual fashion.

As with any high-performance rocket, paint the EFA Payloader with bright colors for easy visibility. The original was painted red, with black nose cones on the pods and a white payload section. A gantry was added to the launch pad for even more spectacular demo flights.

The prototype was launched successfully using Centuri "Sure-Shot" igniters and two clip whips each containing four micro-clips. Remember, if four engines are used, all must be ignited.

Parts List

3 Pod Tubes	BT-20J
1 Body Tube	BT-60D
1 Payload Section	PST-60R
1 Engine Holder	EH-2060
3 Nose Cones	BNC-20R
1 Nose Cone	BNC-60AH
1 Launch Lug	LL-2C
1 Nose Block	NB-60
1 Screw Eye	SE-1
1 Shock Chord	SC-2
1 Parachute	PK-24

(All parts available from Estes Industries.)

the Escape Tower

BY BOB PARKS



USAF MANNED ORBITING LABORATORY SEMI-SCALE TITAN III-M

This month's randomness is a semi-scale Titan III-M with Manned Orbiting Laboratory and working strap-ons. The model is based on the Estes Gemini-Titan kit.

The conversion results in a model that is by no means scale, in fact there are several areas where it deviates substantially from the *proposed* Titan III-M (the real MOL project was cancelled). However, it is close

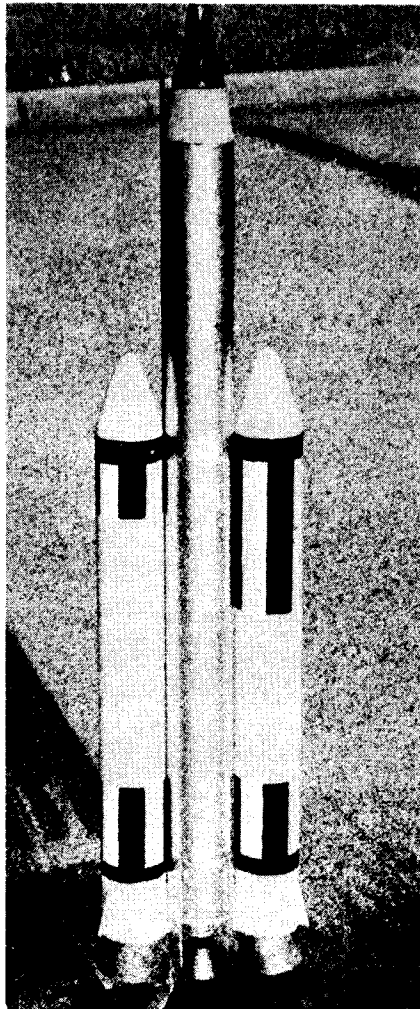

Add a section of body tube and two working strap-ons and your Estes Gemini-Titan will turn into an Air Force Titan III-M.

enough to scale to be recognizable, and looks very realistic in flight. Basic proportions for the model were taken from the drawing on page 37 of the book **Manned Spacecraft** by Kenneth Gatland (Macmillan Company, N.Y.).

Engine selection is very limited. B14-0's **MUST** be used in the pods, while B4-4 or C6-5 engines should be used in the sustainer. The pods *must* use high thrust engines in order to keep them attached to the sustainer. Long burning engines give the best effect in the sustainer.

A typical flight goes as follows. All four engines are ignited at liftoff. The strap-ons burn out and fall off about 50 feet up. The core vehicle continues for several hundred feet more before ejecting a chute and landing. It is very important to get all four engines ignited **SIMULTANEOUSLY**. Therefore, use extra care in installing the ignitors and attaching the clips. A relay ignition system (*Wayward Wind*, Dec. '69 MRm) will be helpful. (NOTE: although relay ignition systems seem to be the best way to fire clusters, extra precautions must be observed. Relays can be easily shorted out, and fire the rocket accidentally. If you are using a regular ignition system to energize the relay coil, check the system before actually firing the rocket. It is possible that enough current will pass through the normal continuity check light to fire the relay. Some sort of safety device in the actual ignition circuit **MUST** be used, even if it means removing both clips from the battery. I don't really need to say that having a four engine cluster go off about a foot away is not a very pleasant experience.)

CONSTRUCTION

Substainer

Only the deviations from the standard kit construction will be pointed out. The step numbers refer to the steps on the kit instruction sheet.

Step 3: Replace the BT-20B with an 18" piece of BT-20. Centering rings are glued on the normal distance from the ends of the tube.

Step 21: Cut two pieces of BT-70, one 9 1/4" long, the other 2" long. Insert the parachute tube in the 9 1/4" tube, using the forward shroud, locate the parachute tube as shown in the instructions. Glue the tube in

place. The 2" tube will be used as a tube joiner to hold the two pieces of BT-70 together. Cut a 1/4" wide strip out of the short tube, and roll it tighter. Cover the inside rear of the 9 1/4" tube with glue, and insert the joiner. About 1" of the joiner should protrude from the tube. Make sure that the joiner is in contact with the outer tube all the way around. Allow to dry. Apply glue to the outside of the exposed joiner, and slide the stuffer tube, and the joiner into the long BT-70. Make sure that the tubes align properly.

You should now have a Gemini Titan that is 9 1/4" longer than normal.

Clear Fins

Due to the increased size and weight of the rocket, larger fins are needed. There *is* sufficient material in the kit to make the larger fins. Use a hot fuel proof type model airplane cement for assembling the fins. I used Ambroid. These glues are much stronger than clear dope.

Step 25: Form the clear plastic tube using the full width of the plastic sheet. Do **NOT** cut it to 2-7/16" as directed in the instructions. The finished tube will extend about 1/2" past the end of the body.

Step 26: Cut out the fins according to the pattern shown in the drawing. Do not make the fins according to the Estes pattern. Glue the fins onto the tube so that the leading edge is even with the front of the tube. The root edge of the fins will extend past the rear of the tube. Apply a fillet for strength.

Strap-ons

Glue an engine block into the front of a 2-3/4" piece of BT-20. (These can be cut from the original kit stuffer tube.) Cut the spacers out of balsa at least 1/8" thick. Glue four spacers onto the BT-20. They are glued on like fins. The spacer should be even with the front of the BT-20. Apply a fillet. Allow to dry thoroughly.

Nose cones are a bit of a problem. There is only one nose cone made to fit a BT-70. It doesn't really resemble the nose on the real Titan. The best thing to do is to turn your own. If you can't do this, the Estes part is the only way out. It is possible to sand the Estes nose cone so it is closer to scale. Sand the base of the nose so it is a loose fit in the BT-70.

Now test fit the engine holders in the BT-70. Sand until they are a slip fit. It is not essential that the engine is exactly centered in the body. Glue the engine holders in place. The rear of the BT-20 should be flush with the rear of the BT-70.

Bend the couplers out of 1/32" music wire to the shape shown in the drawings. Glue the rear coupler to the outside of the strap-on. The coupler should be flush with the end of the tube, with the open end of the hook forward. Use epoxy and add a piece of cloth for reinforcement. Punch a 1/16" hole in the BT-70 about 1 1/2 inches from the front. The hole should be directly in front of the center of the rear coupler. Insert the coupler in the hole, and use epoxy and cloth on the inside of the body to hold it in place. The rear coupler hooks over the rear of the clear plastic tube.

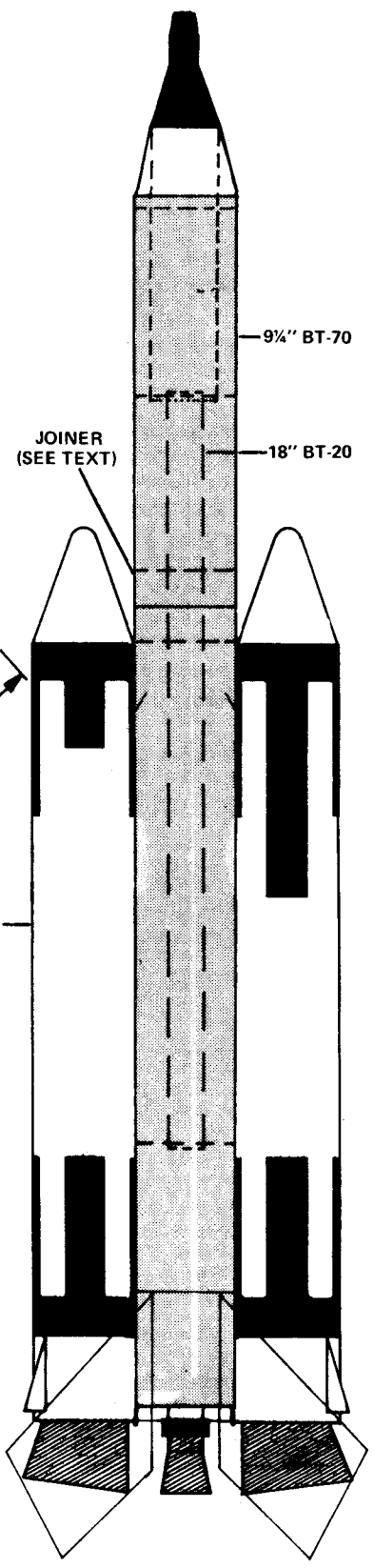
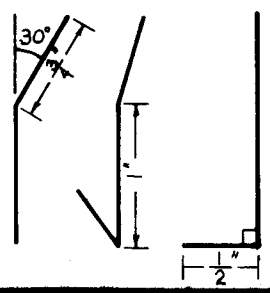
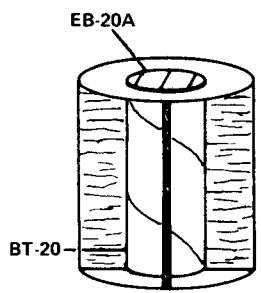
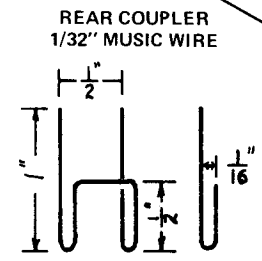
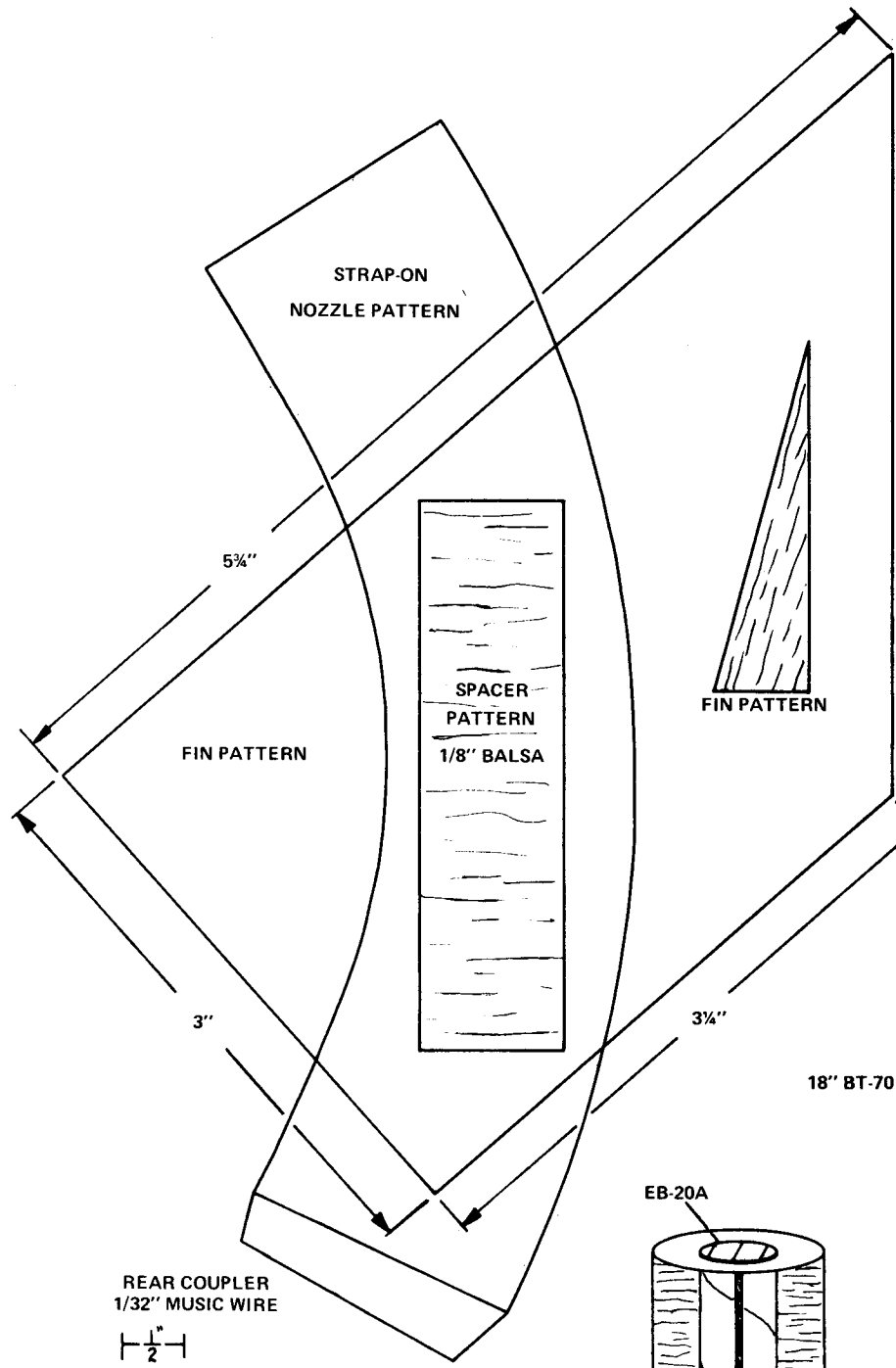

R. SINGER 7/12/70

WHAT'S YOUR FAVORITE ARTICLE THIS MONTH?

Vote here for your favorite articles. List them in order - the most-liked first, etc.

1. _____
2. _____
3. _____
4. _____
5. _____
6. _____
7. _____
8. _____
9. _____

Clip this section out or use a facsimile. Paste on a postcard or enclose it in an envelope and send to:

Reader Survey
Model Rocketry Magazine
Box 214
Boston, Mass. 02123

Thrust is transferred from the pods to the sustainer through the rear coupler. The front coupler slides into a hole in the sustainer. Its only purpose is to keep the front of the pods aligned properly. Very carefully locate the hole for the front coupler on the sustainer. Punch it out with a piece of the music wire. The strap-ons should *NOT* fall off by themselves. It should take a light tap on the nose to disengage them. Adjust the rear couplers as shown until the proper fit is obtained.

Cut a disc of light cardboard to fill in between the engine holder tube and the outer body. Glue it in place, and apply a fillet. Cut and shape the dummy nozzles from file folder material. Glue the nozzles to the back of the strap-ons. Note the angle of the nozzles. Cut and glue on the small fins. The strap-ons are now finished.

FLYING

Use B4-4 or C6-5 engines in the sustainer. B14-0 engines are absolutely necessary in the pods. Booster engines can eject chutes, however normal ejection charges have much more power. Therefore be very careful when packing the chutes in the pods.

A clip whip with four pairs of leads should be used to hook up the engines. Be careful not to get the leads mixed up. Color coding might be helpful. Put the sustainer on the rod first, and hook it up. I find that it is easiest to attach the clips to the strap-ons before attaching the strap-ons to the

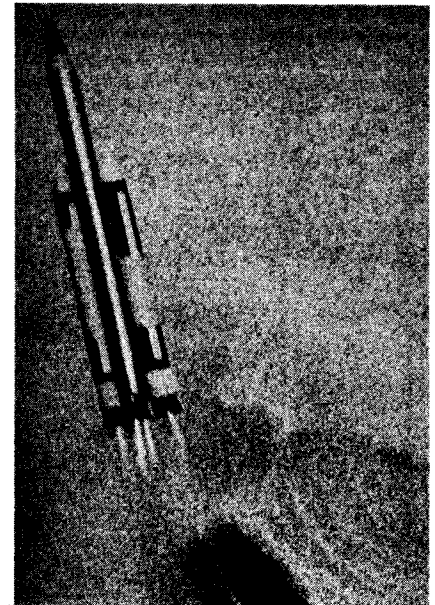

There is a long moment arm on those B14's. Both engines must ignite at exactly the same time or the rocket will curve on leaving the rod.

It may be necessary to block up the strap-ons to hold them in place.

Now let's see, using BT-100, and 2 D13-0's and 2 E5-6's it would come out to be

New Product Notes

The introduction of the ASTRON SPRINT by Estes Industries gives rocketeers an opportunity to build a high-altitude competition model. Designed to give the highest performance in its class, the ASTRON SPRINT incorporates the most efficient aerodynamic shapes for the velocities it will encounter. Use one C6-7 engine and this sleek bird will soar to altitudes nearing 1,600 feet.

While thrilling the advanced rocketeer who is looking for top performance, the ASTRON SPRINT will also appeal to the beginner who wants a kit he'll have an easy time putting together. The kit (catalog number 701 K-49) is priced at \$1.75 and includes pre-cut fins and tail cone, two-color SPRINT emblem decal, plus one color trim decal and complete illustrated assembly instruction sheet. (Engines are not included.)

Model Product Corporation's new Nike-Smoke semi-scale model rocket kit introduces a real breakthrough in the design of precision plastic parts. The 1/12th-scale model uses a combination of a 35-millimeter fiber body tube and precision-molded polystyrene parts to achieve ease of assembly and precision flying characteristics. There is no balsawood in the kit.

The new one-piece plastic fin assembly

fits *into* the T-35 tube rather than around it as with former models in the Astro Line series. The 18x70 millimeter engine mount has been designed expressly for this fin assembly and consists of two molded plastic rings which hold the T-19 fiber engine mount tube and the wire engine clip. This engine mount snaps together and is glued into the fin assembly with styrene cement.



Designed by MPC's space and model rocket consultant, G. Harry Stine, the Nike-Smoke is a 1/12-scale model with only two small concessions made to enable the parts to be molded. Purist scale modelers are invited to discover for themselves which two (and only two) items depart from scale. These departures are not serious enough to detract from the overall scale qualities of the model, however.

Technical data on the Nike-Smoke is as follows: It uses a T-35 (35 mm o.d.) body tube and is 490 mm. long. No-engine weight is 67 grams with an MPC 356 mm. parachute. Assuming the NASA prototype's drag coefficient of 0.45, predicted altitudes of the model are 35 meters with a Type A3-2

engine, 105 meters with a Type B3-3, and 244 meters with a Type C6-4 engine, assuming a sea-level launch at 70° F. air temperature.

Although the MPC model rocket engines produce a dense tracking smoke trail during coast, MPC gives instructions for creating a smoke puff at apogee using kitchen flour.

The MPC Nike-Smoke is an excellent beginner's scale model because of its ease of assembly and excellent flight characteristics. This permits a modeler to concentrate on workmanship, the hallmark of the successful scale modeler. Experienced scale buffs will also find it an excellent entry for NAR Scale Altitude competition, and it is an excellent entry for Predicted Altitude competition because of its known flight characteristics and smooth, precision-aligned plastic parts. Last but not least, the MPC Nike-Smoke will be a boon to those competitors who wait until the night before the contest to build their models!

Fin Pattern Guides, Shock Cord, and Flight Data Sheets are among the new items introduced by Darryl Henderson, 26 Knight Avenue, Marblehead, MA. 01945. The fin pattern guide, including designs for 14 different fins, is priced at 25¢ per copy. Shock cord is available in 10 foot lengths, in either 1/8" or 1/4" width. The 1/8" width is priced at 25¢, 3 for 60¢, or 18¢ each in quantities over 5. The 1/4" width is priced at 30¢ each, 3 for 75¢ or 22¢ each for 5 or more. Flight data sheets, in packages of ten, are priced at 25¢ a package.

THE 8-TRACK STEREO TAPE CARTRIDGE PLAYER OF YOUR CHOICE

FREE*

YOURS AS A GIFT JUST FOR JOINING NOW

Stereo Tape Club of America



*with one year membership and minimum tape purchase, six now and one a month for a year; speakers extra

PICK ONE FREE *

NEWEST FINEST SOLID STATE AUTOMATIC 8-TRACK STEREO TAPE CARTRIDGE PLAYERS



\$119.95
reg. price

COMPLETE HOME SYSTEM
With built-in amplifier and 2 deluxe stereo speaker units in handsome walnut cabinets. **THE PLAYER IS FREE.** We will bill you only special member's price of \$29.95 for speakers. check HOME SYSTEM in coupon.



1970
MODELS
\$79.95
reg. price

HOME PLUG-IN SYSTEM
Pre-amplified model. Plugs into your present stereo record system. Beautiful walnut grain finish. **THE PLAYER IS FREE.** No speakers needed, plays through your own stereo system. check HOME PLUG-IN in coupon.



\$89.95
reg. price

DELUXE AUTO SYSTEM
Complete with easy installation kit and 2 deluxe flush mount speakers (no drilling holes). **THE PLAYER IS FREE.** We will bill you only special member's price of \$11.98 for speakers. check AUTO SYSTEM in coupon.

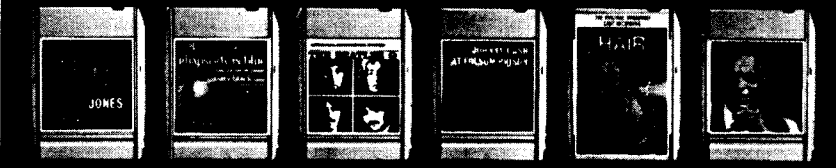

SELECT ANY 6 STEREO TAPE CARTRIDGES TO START MEMBERSHIP

Only Stereo Tape Club gives full selection of all labels, artists, new releases.

POPULAR

- 1311—THE BEST OF NANCY WILSON (Capitol) 6.98
- 1316—HONEY, Bobby Goldsboro (United Artists) 6.98
- 1318—ELVIS' GOLD RECORDS, Elvis Presley (RCA) 6.98
- 1319—WHEN YOU'RE SMILING, Nat King Cole (Pickwick) 5.98
- 1321—FRANK SINATRA'S GREATEST HITS (Reprise) 6.98
- 1324—PROMISES, PROMISES, Dionne Warwick (Scepter) 6.98
- 1326—AGE OF AQUARIUS, 5th Dimension (Liberty) 6.98
- 1328—THIS IS TOM JONES, Tom Jones (Parrott) 6.98
- 1330—A MAN ALONE, Frank Sinatra (Reprise) 6.98
- 1331—I TAKE A LOT OF PRIDE, Dean Martin (Reprise) 6.98
- 1332—FOR ONCE IN MY LIFE, Vikki Carr (Liberty) 6.98
- 1338—ENGELBERT, Engelbert Humperdinck (Parrott) 6.98
- 1339—LIVE, Glen Campbell (Capitol) (twin pack) 13.98
- 1340—HURT SO BAD, The Lettermen (Capitol) 6.98
- 1343—LIVE IN LAS VEGAS, Tom Jones (Parrott) 6.98
- 1344—RAINDROPS KEEP FALLIN' ON MY HEAD, B. J. Thomas (Scepter) 6.98
- 1347—THE RAY CHARLES STORY VOL. II, Ray Charles (Atlantic) 6.98
- 1348—THE GOLDEN SOUNDS, Pop. Various Artists Campbell-Letterman-Wilson Lee-Others (Capitol) 6.98
- 2310—GREATEST HITS, Herb Alpert And The Tijuana Brass (A & M) 6.98
- 2319—THE WAREHouses OF FERRANTE & TEICHER (Sunset) 6.98
- 2320—SOUNDS OF PARADISE, Martin Denny (Sunset) 6.98
- 2323—LET THE SUNSHINE IN/MIDNIGHT COWBOY, Paul Mauriat (Phillips) 6.98
- 6307—COWBOYS & COLORED PEOPLE, Flip Wilson (Atlantic) 6.98
- 6316—BEST OF BILL COSBY, (Warner Bros.) 6.98
- 6321—LIVE AT SING SING, Moms Mabley (Mercury) 6.98

ROCK AND FOLK

- 3301—LADY SOUL, Aretha Franklin (Atlantic) 6.98
- 3312—THE BEST OF WILSON PICKETT (Atlantic) 6.98
- 3314—HISTORY OF OTIS REDDING (Volt) 6.98
- 3325—CLOUD NINE, Temptations (Gordy) 6.98
- 3326—FOR ONCE IN MY LIFE, O. C. Smith (Columbia) 6.98
- 3327—BLOOD, SWEAT AND TEARS, (Columbia) 6.98
- 3328—LOVE CHILD, Diana Ross and the Supremes (Motown) 6.98
- 3330—THE BEATLES 1 & 2 (Apple) (twin pack) 13.98
- 3335—ARETHA'S GOLD, Aretha Franklin (Atlantic) 6.98
- 3342—THE BEST OF CREAM, The Cream (Atco) 6.98
- 3350—GREEN RIVER, Creedence Clearwater Revival (Fantasy) 6.98
- 3351—THROUGH THE PAST DARKLY, Rolling Stones (London) 6.98
- 3352—SANTANA, (Columbia) 6.98
- 3355—HEY JUDE, The Beatles (Apple) 6.98
- 3356—BAND OF GYPSYS, Jimi Hendrix (Capitol) 6.98
- 3357—DEJA-VU, Crosby, Stills, Nash & Young (Atlantic) 6.98
- 3358—AIN'T IT FUNKY, James Brown (King) 6.98
- 3361—ALIVE-ALIVE-O! PART I, Jose Feliciano (RCA) 6.98
- 3362—PSYCHEDELIC SHACK, The Temptations (Gordy) 6.98
- 6315—LADIES OF THE CANYON, Joni Mitchell (Reprise) 6.98
- 6320—BRIDGE OVER TROUBLED WATER, Simon and Garfunkel (Columbia) 6.98

COUNTRY AND WESTERN

- 4301—TIME I GET TO PHOENIX, Glen Campbell (Capitol) 6.98
- 4309—JOHNNY CASH AT FOLSOM PRISON, (Columbia) 6.98
- 4315—JOHNNY CASH AT SAN QUENTIN, (Columbia) 6.98
- 4317—THE BEST OF CHARLEY PRIDE, (RCA) 6.98
- 4318—I LOVE YOU MORE TODAY, Conway Twitty (Decca) 6.98
- 4319—TAMMY WYNETTE'S GREATEST HITS, (Epic) 6.98
- 4321—THE BEST OF JERRY LEE LEWIS, Jerry Lee Lewis (Smash) 6.98

- 4322—THE GOLDEN SOUNDS, Country, Various Artists: Hazard, James, South, Owens, Others (Capitol) 6.98

JAZZ

- 5307—THE BEST OF WES MONTGOMERY, (Verve) 6.98
- 5312—MEMPHIS UNDERGROUND, Herbie Mann (A&M) 6.98
- 5313—SOULFUL STRUT, Young Holt Unlimited (Brunswick) 6.98
- 5317—BUDDY AND SOUL, Buddy Rich Big Band (Liberty) 6.98
- 5318—LIVE AT THE WHISKEY A-GO-GO, Herbie Mann (Atlantic) 6.98
- 5320—SWISS MOVEMENT, Les McCann, Eddie Harris (Atlantic) 6.98
- 5321—SOUNDS GREAT, Jimmy Smith (Sunset) 6.98
- 5322—DOWN TO EARTH, Ramsey Lewis Trio (Mercury) 6.98

SHOW AND CLASSICAL

- 6301—DR. ZHIVAGO, Original Sound Track (MGM) 7.98
- 6308—SUNNY GIRL, Barbra Streisand, Orig. (Columbia) 7.98
- 6310—HAIR, Original Broadway Cast (RCA) 7.98
- 6312—ROMEO & JULIETTE, Orig. Sound Track (Capitol) 6.98
- 6314—PAINT YOUR WAGON, Original Sound Track (Par) 7.98
- 6316—HELLO DOLLY, Barbra Streisand Orig. Sound Track (20th Cent. Fox) 7.98
- 6317—THE GOOD, THE BAD AND THE UGLY, Original Soundtrack (Sunset) 6.98
- 7301—MY FAVORITE CHOPIN, Van Cliburn (RCA) 6.98
- 7303—GERSHWIN RHAPSODY IN BLUE, Lon. Fest. Orch. (Lon.) 6.98
- 7319—2001: A SPACE ODYSSEY, Orig. Sound Track (MGM) 6.98
- 7317—BEETHOVEN'S GREATEST HITS, Bernstein Ormandy, (Columbia) 7.98
- 7318—THE UMBRELLAS OF CHERBOURG, Michel Legrand (Phillips) 7.98
- 7316—THE GOLDEN SOUNDS, Classics, Various Artists (Capitol) 6.98

If coupon removed write to:
Stereo Tape Club of America
P.O. Box 2986, Clinton, Iowa 52732
† Trademark of ©1970
Stereo Tape Club of America

WHY WE GIVE YOU THE FINEST 8-TRACK STEREO PLAYER FREE

We are America's largest all-label, all-artist stereo tape cartridge club. We hope to win you over to the newest, most advanced, most convenient way to enjoy music in your home, car and office — with trouble-free, compact stereo tape cartridges that play continuously, switch tracks automatically, and last practically forever. They never scratch, warp or wear out. They never tangle.

If you like the system, you'll buy your stereo tape cartridges from us. You never pay more than regular price. You can pick free bonus tapes immediately, without waiting. You can enjoy up to 50% savings.

To guarantee your continuing interest, the equipment must be fine enough to give you brilliant high fidelity performance over many years of trouble-free service. That's why we give you our STEREO Matic unit FREE. It's premium equipment. The best. We know you will be delighted. That's why we are willing to send it to you at no risk or obligation on your part. If you like it, KEEP IT. It's yours FREE just for buying stereo tape cartridges you would want to own anyway. If not, return it and your membership is cancelled. You pay nothing and owe nothing. To take advantage of this fabulous new membership offer, complete the coupon and mail now.

SEND NO MONEY • JUST MAIL

Stereo Tape Club of America
P.O. BOX 2986, CLINTON, IOWA 52732

Please enroll me as a member and send the FREE Stereomatic 8-track tape cartridge player checked below.

- HOME SYSTEM (speakers \$29.95)
- HOME PLUG-IN (no speakers)
- AUTO SYSTEM (speakers \$11.98)

Also send the 6 stereo tape cartridge albums I am buying now to start my membership. (Select 6 from list, print numbers below.)

--	--	--	--

Bill me for these, plus shipping and handling charge. I may pay in 3 monthly installments if I wish. If I am not 100% satisfied, I may return player and cartridges in 10 days and my membership will be cancelled. I owe nothing.

Name _____ Age _____

Address _____

City _____ State _____ Zip _____

Home Phone _____ Area Code _____

Credit References _____

Military: Include serial number, military address and home address with application.

Credit card: Charge above order to my credit card.
 BankAmericard Master Charge Amer. Express Acct. # _____ Diners Club

MY MAIN MUSICAL INTEREST IS: (check one)
 Popular Rock & Folk Show & Classical

In addition to the 6 cartridges I am buying now to start my membership, I agree to purchase a cartridge a month during the coming year at the regular club price, plus postage and handling. (Albums you'll want to buy anyway; thousands to choose from.)

SIGNATURE (REQUIRED) _____
1-232-6-20339

B/G designs were many and varied at the first NAR Sanctioned Condor B/G event. After two days of flying the final score was three "successes" and too many failures to be counted

NART - 1

by George Flynn

Condor boost/glide, being flown for the first time in an NAR sanctioned event, was expected to be the highlight of the first NARCAS Annual Record Trials (NART-1). Sponsored by the NAR Capitol Area Section (NARCAS) located in Harrisburg, Pennsylvania, the meet was held at the Indiantown Gap Military Reservation on May 15-17, 1970. On the schedule were attempts to surpass old NAR and FAI records in Eggloft, PeeWee Payload, Design Efficiency, Class 1 PD, and Hornet B/G. Since no Condor B/G flights were on record the object was simply to get a Condor to fly.

With the catastrophic experience of Hawk B/G at ECRM-4 only a few weeks behind, the rocketeers (many of whom had flown at ECRM) were familiar with the fragileness of balsa under the high accelerations necessary to lift a boost/glider. Some radical new designs were of course expected, and no one would be disappointed on this score. Even before the opening flight session some of the most unusual B/G's ever assembled were seen sitting on beds, in closets, and sticking out car windows. By their nature (usually LARGE) Condor B/G's are quite hard to conceal.

Over in one corner of the IGMR barracks, Bob Parks was assembling an eight-foot C-rail launch tower for his "flop-wing" B/G. The "flop-wing" is an interesting concept in which the wing is

folded back on itself giving it only one half of its glide span during the boost phase. It's a bit hard to describe a "flop-wing," suffice to say that a design article on one will be featured in the September 1970 issue of *Model Rocketry*.

Ten feet away Bruce Blackstone was adding the finishing touches to his "Disaster 17-B." Bruce's B/G's usually look like disasters, however his frequent victories have convinced most everyone that his gliders are always *strong enough* to stay together. Just keeping the B/G together is at least half the battle in these large B/G events. The Disaster 17-B, with a five foot, T-beam boom made from two pieces of 1/2" thick spruce, looked like no exception to Bruce's usual "build them strong" rule. This glider was a scaled up version of Bruce's standard, canard wing "Valkyrie" series. Power was supplied by an FSI F100 engine.

Across the room Guppy and Sam Atwood are finishing (starting?) construction of Guppy's flexwing canard B/G. Using thin black plastic for the wings, Guppy's B/G looked like the mast of a sailing ship when assembled. After much cutting and gluing the glider, a tribute to 5-minute epoxy, was ready for its maiden flight. The fact that it was 1:20 AM cut down on the number of spectators, but at least ten ardent rocketeers assisted with the test glide. Guppy climbed up the fire escape and tossed the glider into the air. The glide ratio

was about 1:2 (that's two feet down for every foot of horizontal flight), and one spectator commented: "It flew like a streamlined brick." Guppy was undiscouraged, however, as he returned to the barracks to get the "Gargoyle" ready for flight in the morning.

Howard Kuhn, whose preference for Mantas is well established, came up with another one — the Maxi-Manta designed for F7 power. With about a one-foot span, the Maxi-Manta was designed to carry a radio control unit in a fuselage pod. At NART however, this B/G was being flown without the radio unit, and with a special FSI F7-4 engine designed to allow ejection at peak altitude. The Maxi-Manta's glide weight is only 3.5 ounces making it one of the lightest Condors in the contest. (Look for this one in kit form from Competition Model Rockets in the near future. It will be offered either with or without the radio pod, and the radio equipment itself will be standard ACE R/C units.)

Two of the NARCAS Condor designers took a different approach — employing a small glider attached to a big pod. Both Carl Guernsey and Mike Coxen showed up with these small gliders, at least small by Condor standards. With spans and lengths of under one foot, these gliders seemed to be quite strong and durable.

After a quick Army breakfast, everyone (well, almost everyone . . . there were a few stragglers who couldn't seem to get up before noon) assembled at the launch field early Saturday morning. The weather was not promising, with two distinct cloud layers clearly visible. The meet started with a word of welcome by Lt. Col. Robert Wolfe, IGMR Operations and Training Officer, who had arranged for the use of the IGMR facilities. He was followed by Francis Guernsey, who set down the ground rules for the meet. It seems that IGMR has a Vietnamese Village used for training purposes, and it was located just across the road from our launch site. "There is one area that is particularly taboo," she warned, "that is the Vietnamese village. Any rocket landing in that area will be DQ'ed." She continued, "There may be some firing of live ammunition in the firing area. Do not go into that area. The Army will also have some jet strafing runs. Do not shoot a rocket at the jets, if you break it you bought it." Oh well, you can't expect the Army to come to a complete halt just because there are one

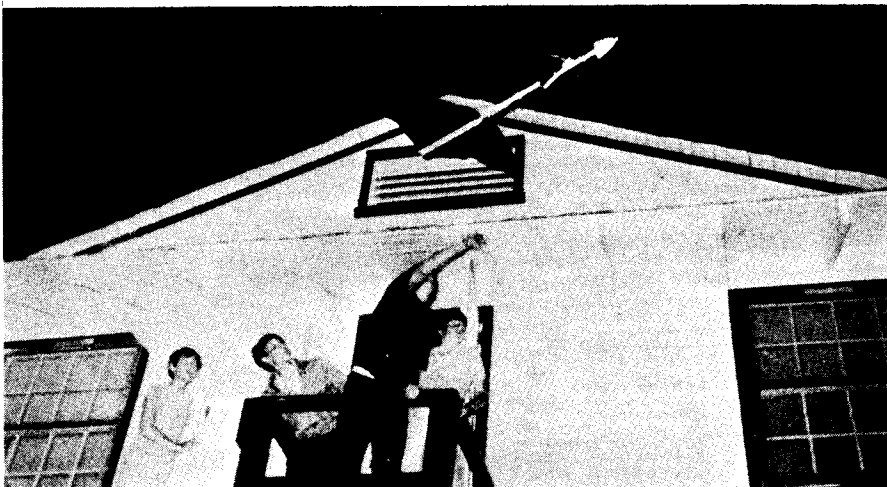

Guppy (AAR) test gliders his "Gargoyle" from the fire escape of the IGMR barracks. This 1:20 AM test flight attracted 20 spectators — rocketeers who, according to the schedule, had been asleep for nearly two hours.



Shiela Duck prepares her egglofter for launching. At ECRM the same rocket was tracked to 402 meters, but a low ceiling at NART caused it to go untracked. Most other egglofters suffered a similar fate.

hundred or so people in their target area.

By 9:00 AM the first rack of demo birds was set to go. We quickly discovered that even under B-engine power that rockets would disappear into the clouds — and Eggloft has an 80 nt-sec limit. With a 500 to 800 foot ceiling, tracking had to be poor. After some discussion it was decided that the weather couldn't possibly get worse, so why not start flying and hope things would get better. Of the first 7 egglofters off the pad only one was tracked and there were three catastrophic failures. The trackers were instructed, if the bird went through the clouds, to track it to the last point where they saw it (the base of the clouds). Howard Kuhn was winning with his Elo until the cloud ceiling lifted a little and Raymond Werre's egglofter was tracked a few feet higher than Howard's. Each rocket was still thrusting when it disappeared into the clouds. Needless to say, no new eggloft records were set, but the tracking data provides good information on the local cloud ceiling.

Design Efficiency birds were also getting lost in the clouds, so it was decided to allow additional tracking flights on Sunday, *weather permitting*. About this time Tracking East noticed some strange clouds

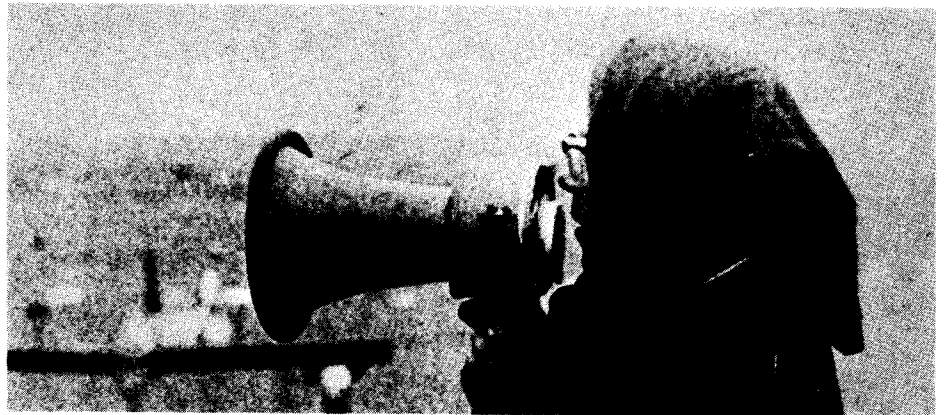

"The weather keeps getting better and better," reports CD Carl Guernsey, Sr., as the ceiling lifted high enough to allow the pad area to be seen from the launch panel. Two days of rainy weather did not, however, dampen the spirits of the rocketeers who had come to see the Condors prang.

drifting towards them. Bob Singer, a veteran of the "Harvard Square riot", observed that they had been tear gassed. Considering the number of closed tracks, one rocketeer observed that they deserved it.

After lunch the big, heavy Condor B/G's were brought out. Even with the low cloud ceiling it was expected that these rockets could be timed. The first Condor off the pad was built by Carl Guernsey. The boost was fine, but it didn't pull out from the dive. Splat! and Condor B/G was off to an auspicious start.

My rocket, a flexwing with a "flop-wing" stabilizer, was the next one off the pad. With an F100 I was sure it would rip to pieces, so I chose to fly it with an F7. Unfortunately, the only F7 generally available is the FSI F7-6, and six seconds of delay was a little bit too long. One fin apparently ripped off on the way up, and the rocket weathercocked severely. The flexwing never got a chance to flex, with *impact* coming about three seconds into the delay charge. Only the one ounce payload weight flying in the nose was salvageable!

Next up was Paul Conner, who can usually build a good boosting and fantastic gliding (at least by today's standards) B/G in any category. The boost was great, straight up through the clouds... but the rocket was never seen again! Paul assumes that the B/G worked. If it hadn't deployed and glided properly, it should have impacted

within site. But how do you time a B/G that disappears permanently at T plus two seconds. Paul has been denied membership in the exclusive "Condor Prangers" club, but he couldn't claim a record either.

Jim Barrowman designed an unusual (though no more unusual than some of the others) Condor B/G. He used a parawing — a thin plastic folding wing — lofted inside a standard cylindrical-body rocket. He suffered a catastrophic failure during boost, picked up all the wreckage, and was informed "you can fly it again... if you can put it back together."

Bruce Blackistone's Disaster 17-B was quickly prepped for an F100 flight. It lifted off and started climbing... straight up. But at thirty feet in the air it was enveloped by a cloud of balsa scraps! The wing had *disintegrated*. Finally someone had managed to produce an engine that could destroy a Blackistone creation. Bruce recovered the boom while other NARHAM's members

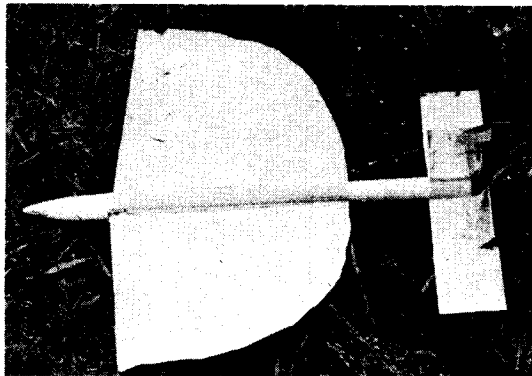

The Flynn "flip-flop-flex wing" never got a chance to flip, or flop, or flex as it impacted with five seconds yet to go on the delay charge (see photo at right). One fin ripped off on the way up, causing the rocket to arc over and prang.



Jim Barrowman displays the remains of his Condor attempt. The rocket body previously housed a parawing glider which would have been deployed at apex. Like most of the Condors, it didn't quite make it.



Bruce Blackistone (left) displays his "indestructible" B/G, the Disaster 17-B, just before its first — and last — F100 powered flight. All the parts of its shattered wing were recovered and reassembled (right) to evaluate the cause of the failure. The conclusion: even ¼" thick balsa can't stand up to F100 power.

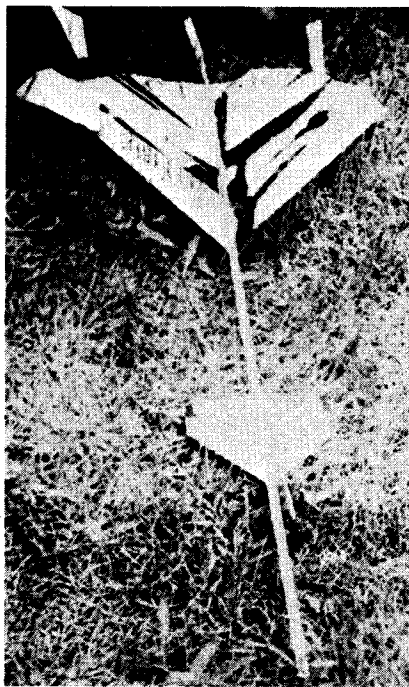

Alan Stolzenberg prepares his Condor for its first flight. The results were the same as Bruce Blackistone's, but not enough of Alan's wings could be recovered for reassembly.

scattered over a 50 foot radius recovering scraps of the wing. Within minutes all the parts had been recovered, and Bruce had reassembled the B/G on the ground. He quickly determined that a structural failure resulted in the crash.

Guppy ran into a problem with his "Gargoyle's" qualifications to fly in Condor. Designed for power by two Estes D-engines, the "gargoyle" would be in the Eagle not Condor category with that total impulse. He added a ½A retro-fire engine. It did nothing, but it increased the total impulse to 40.125 nt-sec, just over the 40,000 nt-sec minimum limit for the category. An elaborate "pad area" with booms to hold the igniters in the air (and pull the clips away from the rocket as it took off) was prepared. The "Gargoyle" lifted off perfectly, but the canards did not deploy,

giving it an even worse glide ratio than a streamlined brick. It pranged! Looking over the glider, Guppy thought about adding two retro-fire D13's to the monster. He commented that adding the D's wouldn't help it fly, but "it doesn't fly so it really doesn't make any difference what I do to it anyway." With major modifications he hoped to have it ready for another flight on Sunday. *HELP!*

Mike Coxon's Condor, a small glider with a large pod holding three D engines, went wild as the pod ripped off at T plus 1 second. Alan Stolzenberg's 3/16" boom broke just behind the wing, and his Condor, built to standard B/G design, disintegrated on the way up. A couple of other attempts followed, and at the end of the first day of Condor flight the record was *10 ATTEMPTS, NO SUCCESSES*. But there

still were some Condor's scheduled to fly on Sunday, perhaps someone could get one to hold together long enough to qualify.

It was still light after dinner, so about 20 rocketeers gathered at the flying field for some test flights. Jim Kukowski had two or three beautiful flights with his styrofoam wing Hornet — actually from the wing span it looked more like a Sparrow, but the styrofoam wings made it light enough to fly in Hornet. He was turning in times of about a minute. Howard Kuhn was testing a styro-



Jim Sparks explains the operation of his variable geometry B/G design. The wings fold back against the body during boost, and extend during glide. Unfortunately the T-tail caused the boom to snap during the boost phase of flight.



My five foot tall "Infinite Loop" became the first Condor to fly "successfully". Its 22 second flight was quickly topped by the next successful Condor to fly.



Mike Coxen's Condor was more pod than glider, with a small B/G attached to a 3 D-engine cluster pod.

foam version of his Mini-Manta. This small version of the Manta was also turning in one minute flights. It's performance was quite a bit better than a similar model built with balsa wings. It looks like styrofoam might be the way to go for small competition B/G's.

Steel City's Lieberman-Crafton team was a bit concerned about the transition on their Condor scheduled for flight the next morning. Since the new NAR-HIAA Safety Code requires conducting "launchings of unproven designs in complete isolation from persons not participating in the actual launching," Marvin Lieberman insisted on a test flight. They prepped the glider with only a C-engine, not too much power for something intended to fly in Condor. The B/G was destroyed by the flight, and with it their chances of a Condor victory seemed small. They planned, however, to put something together by morning.

Dick Fox and Alan Stolzenberg prepared a Foxmitter breathing rate unit for flight. Alan loaded "Herman", a veteran of one previous rocket flight, into the mouse cap-

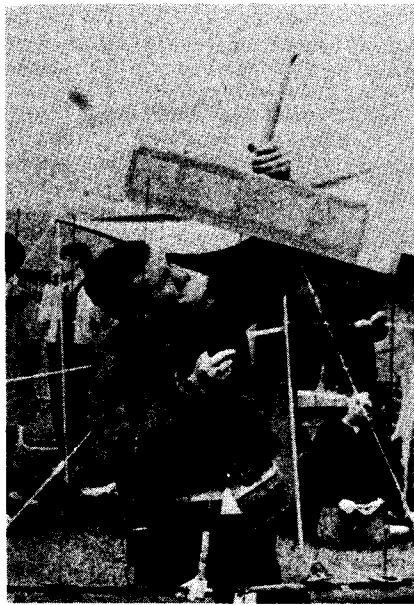

Joe Bilbo came up with an F100 powered Flying Jenny. Unfortunately it looped too low... catching the ground.

sule while Dick prepared the rocket. Though the parachute failed to deploy, Herman was recovered unharmed, and Dick obtained a complete data tape of the flight. By this time it was getting dark, and everyone returned to the barracks to continue construction.

Most everyone was up before dawn on Sunday morning. Actually there never was a visible dawn that morning... it was pouring outside. Not drizzling, not raining, but pouring. Serious rocketeers are not easily discouraged, however, and the weather report was promising. With luck the rain should let up by noon. Furthermore, one observant rocketeer noted that the ceiling was higher than it had been on Saturday.

After breakfast the CD, Carl Guernsey Sr., held a meeting to decide whether the remaining events should be canceled because of the continuing rain and muddy field conditions. Bruce Blackistone summed up the sentiments of the group when he insisted: "We launched in rain and drizzle at MARS, thunderstorms at ECRM, and why not sloop at NART?" With that said, almost



Howard Kuhn connects the leads to his Maxi-Manta. On its third flight the F7 was replaced by an E and two C's in the strap-ons. It didn't help, however, as the B/G pranged anyway.

everyone went out to the field and helped set up the range.

With jackets and plastic sheets protecting the launch panel, Carl Guernsey Jr.'s pants protecting the CD's head, and a small tent set up for data reduction, the range was declared open. The CD noticed a slight increase in the ceiling and commented "the weather keeps getting better and better" as the rain continued. Shortly afterwards the Army advised that, since it was Armed Forces Day, a demonstration air strike was expected about a mile from us. Unfortunately there was less than a 1000 foot ceiling, and it was hoped the aircraft would find the correct open field.

Since I had a 5 foot tall "Infinite Loop" down at NART for a demo flight, and since Scott Brown had advised me that sometimes, with proper trimming, an Infinite Loop can glide, I put an F100 in it and flew



Bob Keasley's Condor, the only legitimate B/G to fly successfully in the Condor event, had numerous wire and strut supports to strengthen the wing, stab, and rudder. It turned in a 36 second flight.



Dave Crafton (left) and Marvin Lieberman examine the prize-winning Condor — a Micro-Manta with about 5 square inches of wing area. It went up strapped to the side of the Lieberman-Crafton egglofter, and took 52 seconds to come down.

it in Condor. Surprise number one, it boosted straight up. Surprise number two, the eight second delay was short enough to allow ejection before impact, in fact at about 300 feet altitude. Surprise number three, after the nose cone ejected the Loop *glided!* In fact it glided for 22 seconds, and became the first Condor to fly successfully at NART.

Despite the continued rain, you could tell that things were going to be better on Sunday. The Loop's "record" held just four minutes, since the next Condor off the pad was also *successful*. Bob Kealey had a standard winged glider, strengthened with supporting wires and braces, and powered by two E engines. The boost was somewhat erratic, with the glider transitioning into a powered glide at about 200 feet, but it turned in a 36.4 second flight. He proved that Condor B/G's really can be built!

Parachute Duration was flown in between the Condors. The field was large, but the winds were fairly high, causing considerable drift. The first few rockets to fly experienced considerable difficulty. The cool, moist weather was causing the plastic chutes to stick, and even chute powder didn't seem to help.

Almost none of the large chutes opened, and the winning strategy seemed to be to go with a small chute. Alan Stolzenberg used only a 16" chute in his small, elliptical finned rocket. The chute popped out at apex, and it deployed almost immediately at about 300 to 400 meters. As soon as the chute came out, Alan started chasing the rocket across the field. He got a 3 minute 9 second flight, and returned the rocket 15 minutes later.

Jim Sparks started to prepare his variable geometry boost/glider, and once again attention turned to the Condors. He used standard model airplane construction techniques — a ribbed wing covered with monokote — as well as two hinges allowing the wings to be folded against the fuselage during the boost phase of flight. The B/G was being flown with an F7 engine. After two successive misfires, the B/G got off to a 9 second flight. Since the F7 burns for 9 seconds, you might say that the glider power pranged.

The pod was ripped off by the crash, but



Guppy examines the remains of his 17 foot rocket after a flight every bit as successful as many of the others at NART.

there was no other serious structural damage. Ribbed and covered wings seem to be able to withstand quite a bit of wear and tear. The pod was reglued to the boom, and the glider was ready for a second flight within thirty minutes. This time the engine was a F100. The tail ripped off under power, indicating that neither an F7 nor an F100 is suitable for B/G flight. In fact it was the almost unanimous opinion of the Condor B/G builders at NART that an F25 or F30 engine would be a welcome addition to the engine list.

By early afternoon the weather was showing signs of clearing, and Howard Kuhn brought his Maxi-Manta out of the car. He had it set up to fly with an F7 engine. On its first flight the pod failed to separate from the glider. There was no damage and the glider was quickly readied for a second flight... again with an F7-4 engine. This time the pod had been prepared so that there was no danger of it failing to separate. In fact, Howard had some difficulty in keeping it attached long enough to get the Maxi-Manta on the pad. It looped over shortly after liftoff and power pranged.

Give Howard credit for persistence and his Maxi-Manta credit for its strength however. He replaced the F with an E, and added two "Marcus" strap-on pods containing C's. Once again the boost was somewhat erratic, and the B/G impacted just after engine ejection. The Maxi-Manta was retired for the day. It seemed to have a tendency to do an inside loop during the boost phase, but with a little boost phase trimming there should be no problem with getting the Maxi-Manta to fly.

About this time a group of six rocketeers were seen carrying a flagpole across the field. No, it wasn't a stolen Army flagpole... it was Guppy's 17 foot (yes, *seventeen* foot) tall rocket. It took six people, holding the rocket at strategic places along its length, to keep the rocket from buckling while it was being carried. After about 15 minutes the "rocket" was set to fly. In keeping with the tradition of the Condors, it climbed perfectly to about 50 feet, buckled in two places, and fell to the ground. Fortunately, it had enough surface area so that it fell slowly and safely.

By this time the Lieberman-Crafton team, which had destroyed their original Condor during flight testing, had managed to get a new "boost/glider" together. Actually, their Condor was a Micro-Manta (some what smaller than Howard Kuhn's Mini-Manta entry in the Hornet event) strapped to the side of their egglofter. The Micro-Manta had a wing span of only about 2 inches and a wing area of approximately 5 square inches. The carrier rocket, still carrying their egg from the previous day's egglofting event, was a two-stager powered by D-engines. One of the D's failed and the flight was DQ'ed, but they obtained a 1 minute 44 second flight on the glider. Encouraged by the flight, they quickly started reassembling a new carrier rocket from scrap parts.

The Lieberman-Crafton upper stage, complete with a now *broken* egg, was mated with a new booster, and the Micro-Manta was ready for another flight. It flew high,

and straight up... one of the straightest flights in the entire Condor competition. In fact it flew so high that their 5 square inch B/G was barely distinguishable from the parachute wadding. Furthermore, it fell just as slow. This time the B/G took 51.8 seconds to return to the ground, a Condor time that was not to be exceeded during the remainder of the flights.

Guppy, teaming up with Bob Parks and Bob Singer, had another surprise for everyone. Early in the morning they had rounded up a few spare parts, and assembled a Hornet "flop-wing". It took a three man team, they later explained, to hold all the parts together while the five-minute glue was setting. An *instant B/G* perhaps? In any case, it flew! The flight couldn't be classed as spectacular, but the 54 second duration was good enough to submit as an NAR record.

Joe Bilbo had prepared an oversize "Flying Jenny" for Condor. He was a little worried that the F100 would tear it apart, since the boom had just been glued together where it had broken earlier. In fact, it was a very strong glider, as it proved when one wing survived the F100 power prang!

By this time Guppy had the "Gargoyle" prepped for another flight. Only one of the two D's ignited, and it lifted off the pad at a severe angle... taking a 3/16" launch rod with it. It reached about 10 feet before it started flying horizontally. Two rocketeers dove for the ground, as the "Gargoyle" flew over their heads. It power pranged just outside the launch area. Guppy quickly ran to the crater and commented: "That's strange. I didn't think it would pull a 3/16" rod out of the ground."

That ended the Condors and the meet, and it was time for the awards presentation. Actually there was one more Condor left. Bob Parks' had yet to fly his large "flop-wing" out of the eight foot C-rail tower he had carried down all the way from Boston. But Bob and Guppy were having so much fun flying the "Dove II" as a towline glider that Bob chickened out of flying it in Condor.

Trophies were presented to the first and second place winners in all categories in both Junior and Leader/Senior Divisions. A special presentation was made to Lt. Col. Robert Wolfe of IGMR in recognition of their excellent cooperation with the meet.

After the awards presentation, Bruce Blackistone commanded a launch pad for one final shot... a Dragon B/G. In fact it was the same Dragon B/G he had tried so hard to demolish at ECRM. This time the gods were more cooperative. Powered by a D1.1-6, Bruce's Disaster 10-B buried itself six inches into the IGMR mud.

As it turned out there were four flights at NART-1 which exceeded current NAR and/or FAI records. The Lieberman-Crafton 52 second Condor flight, Alan Stolzenberg's 189 second Class 1 PD flight, Doug Plummer's 80.8 meter/nt-sec Design Efficiency flight, and the Parks-Singer-Guppy Team 54 second "flop-wing" Hornet B/G flight have all been submitted to the Contest Board. Furthermore, as a fitting salute to the success of the meet, the sky cleared just as the rocketeers were leaving IGMR...

Build the "BIO - 1"

by Alan Stolzenberg

After a modeler has had experience flying multi-stage and cluster rockets, and has touched the field of high impulse F engines, he generally looks for something new to work with. Many times he is attracted to flying payloads. When I entered the hobby seven years ago, many modelers were facing that step. What finally resulted was the sadistic torture of animals, to determine if they could survive a model rocket flight.

What made the craze so bad was that no scientific purpose was served. For what experiments were attempted, a centrifuge would have provided a *better controlled atmosphere*. Shoving the biggest possible engine under a poor mouse served no purpose than to get the ASPCA against model rocketry.

Certain people did try to protect the mouse. One member of the Steel City Section devised an escape system. When the rocket tilted to a preset angle, a mercury tilt switch would fire an engine to boost the mouse from the rocket. Murphy's law took it's toll, as usual. Somehow the tilt angle was accidentally crossed before launch. The capsule shot through the grass into oblivion. He never found the capsule, but concluded the mouse must have gotten airsick from looking out his window while skimming through the grass at 150 mph.

The idiocy of animal flying finally struck me when I saw a four engine Prodyne cluster designed to carry a cat or monkey. The stupidity of that idea convinced me to stop work on my project to use three Mini-Max engines to loft an assortment of fish and perhaps a mouse too.

Finally the slaughter of mice, fish, and insects got so bad that the NAR came out against all animal flights. This helped to reduce if not end the fad of mice flying. The introduction of Egg Lofting also helped to curtail animal flights.

Egglofting has served its purpose well. It is an excellent test of one's skill. If you prove to be not quite as skilled as you thought, you merely lift out the plastic bag and dispose of it (if you were smart enough to use one). It also helps with the fourth estate. When we were at the Pittsburgh Press for publicity for the Spring Convention, the reporters and photographers were so interested in an egg lofting that a large part of their article was devoted to it. They thought that rocketeers must be pretty safety conscious and humane to test fly with an egg before an animal.

Egglofting is also great fun. We make sure that it is flown at all of our contests for just that reason. In the light of this project, egglofting has served yet another purpose.

Model rocketeers have learned how to fly high impulse powered rockets carrying a delicate payload.

Last year an item was introduced to model rocketry which justified some animal flights. The development of the "Foxmitter" model rocket transmitter provided a telemetry system for our use. All that remained was the development of a sensor for biological functions. When Dick Fox developed the sensors described last month in this magazine, he asked me to provide a rocket to loft a mouse and a transmitter. (I suggested trying fish, as they are easier to fly, and would probably work well with the sensor. We are currently involved in this project.)

If the transmitter were not being flown, the project would have no justification. After all a centrifuge is a better test device for finding the structural strength of a mouse than a rocket is. Future issues of this magazine will present plans for flying two or more sensors with a single transmitter. This multiplexing will allow the comparison of heart-beat and breathing rate to acceleration, spin rate, and temperature.

Biological Payload Vehicle Construction

Considering the nature of the project, several unusual design features are necessary. The weight of the system demands that either an F engine or a cluster of 3 D engines be used to power the model. I chose the F as its high reliability gave the payload a better survival chance. The basic vehicle is a heavily modified Flight Systems OSO kit, but it is so modified it may not be recognizable. (The fins on the early OSO kit, which was used for these flights, are similar to the fins which now come with the Penetrator kit.)

Lifting Vehicle

The internal construction of the engine section is not very different for this rocket. A FSI engine block, complete with shock cord, should be mounted in an 18 inch FSI tube so that about one and one-half inches protrude. A strong glue such as epoxy or Titebond must be used. Allow the mount assembly to dry completely before trying to move it.

Fins are next on the assembly list. The drawing shows the fin design of the OSO kit, but shape is not that critical if stability is maintained. Check any alterations with the Barrowman C.P. method before flying. I recommend 1/16" plywood for fins. It takes a good finish easily and is nearly *indestructible*.

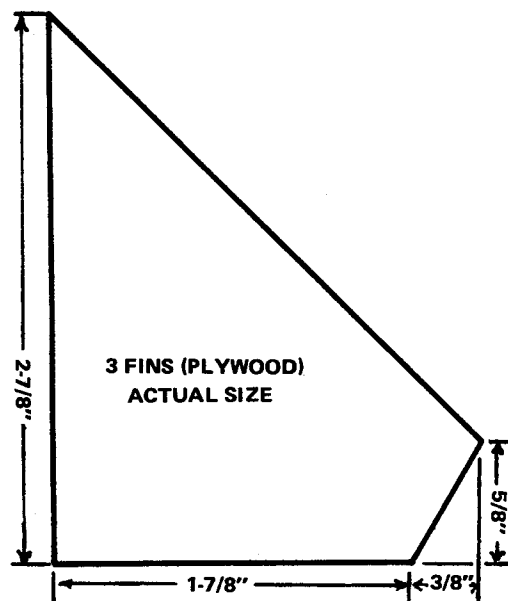
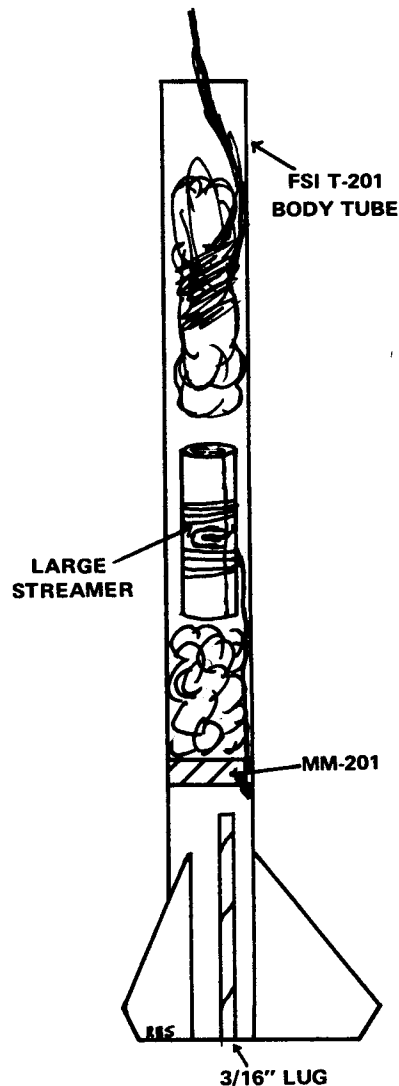

ible. The rocket described took a hard fall onto the runway at Wallops without a dent. If you prefer balsa it must be at least 1/8" thick, but even so it will not stand up as well. Sand the fins to a good aerodynamic shape. This may be difficult to do with plywood, but at least *round* the edges. Remember to leave the root edge square for strength when glued. A fast epoxy or Titebond can be used to anchor the fins in place. Afterwards a coat or two of Elmer's or a similar white glue should be used for a fillet. If you intend to use Pactra Aero-Gloss paints do not use Titebond in the fillet, as it may cause the fillet to swell and crack.

Before you paint the rocket body and fins, epoxy a long piece of aluminum lug with a 3/16" ID onto the rear of the tube. Make sure the alignment is correct. A smaller section may be epoxied to the front end, but again check your alignment. Imagine the poor mouse with an F engine hung up on a rod!

Up to now construction has not been too radical. However, the payload section is very different. You are carrying two payloads, an animal and a transmitter. You must provide suitable accommodations for both. This results in a long payload section. The transmitter must be cushioned and the antenna must hang beneath it. The animal must also be cushioned. (Fish must have a water capsule.) It must be held immobile enough that they stay in contact with the sensor. Connections must also be made between the animal compartment and the transmitter compartment. Due to the improvements in the "Foxmitter" it is not necessary to mount aluminum foil on the payload section.

Transmitter Section

Cut a 10 inch length from a FSI T-201 tube. From another T-201 cut a 3 inch section down one side. This section should now be glued into place in the rear of the 10 inch tube as a stage coupler. The stage



Alan Stolzenberg prepares the "BIO-I" for launch from a 3/16" rail.

coupler should protrude two inches to provide a good shoulder. A block to seal off the end of the shoulder stage coupler should be lathed down, carved, or cut out and glued into place. A nine volt battery for the sensor light is then placed in the hollow part of the coupler with leads attached. Place a piece of foam on top of the battery. Just above the level of the foam, make a small hole for the antenna wire. Remove the foam and battery from inside the tube. Paint the tube with a good high visibility paint.

The remaining 7.5 inches of the T-201 tube should be used for the animal section. A 2 inch piece of T-201 tube should be used as a stage coupler as in the transmitter section. About 1.5 inches should protrude. A block should be cut from heavy stock cardboard and glued in place in the tube immediately above the coupler. Coat the block with glue to increase its strength. After the glue has dried entirely, cut a hole in the cardboard block big enough to pass the photocell through. Next month I will describe plans for the actual capsule in which the animal fits. This will be done because we are still testing the system and are not positive as to which of several designs is best.

Recovery System

The recovery system of this rocket is also different from most. A large streamer should be used on the bottom section. The payload section's system is different as the antenna must hang beneath the transmitter to obtain full signal strength. To make this system, the first step is to put two screw eyes into the base of the nose cone. A 45 inch length of strong nylon cord (I used a 10 pound test fishing line) should be passed through the screw eyes and the ends knotted firmly. When the nose cone is set in place, the two lines should be opposite each other. The nylon leader line should be big enough to reach back to the packed recovery system which is housed in the booster section. As the opening shock from a weight of about 5 ounces is large, either a silk chute or a shock absorber must be used to keep the parachute intact. I used a bungee to protect my chute. To make one, 70 inches of very strong cord and 12 inches of flight rubber are needed. The rubber should be tied to the cord about 3 inches from each end. This allows the rubber to expand, but you still have the cord to keep your chute attached if the rubber breaks. One end of the bungee should be tied to the nylon leader and the other end to the large parachute. Check all knots to make sure they are secure. Seal and paint the rocket with a high visibility paint.

Remember to build it well and build it strong. The animal is relying on your skill as a modeler. If you have never flown F's or an egg successfully, hold off on this project until you have had more experience. Above all, develop your flying skill on eggs *not* animals.

Next month's article will contain plans for the animal's capsule, flight instructions, photographs, and information about our flights.

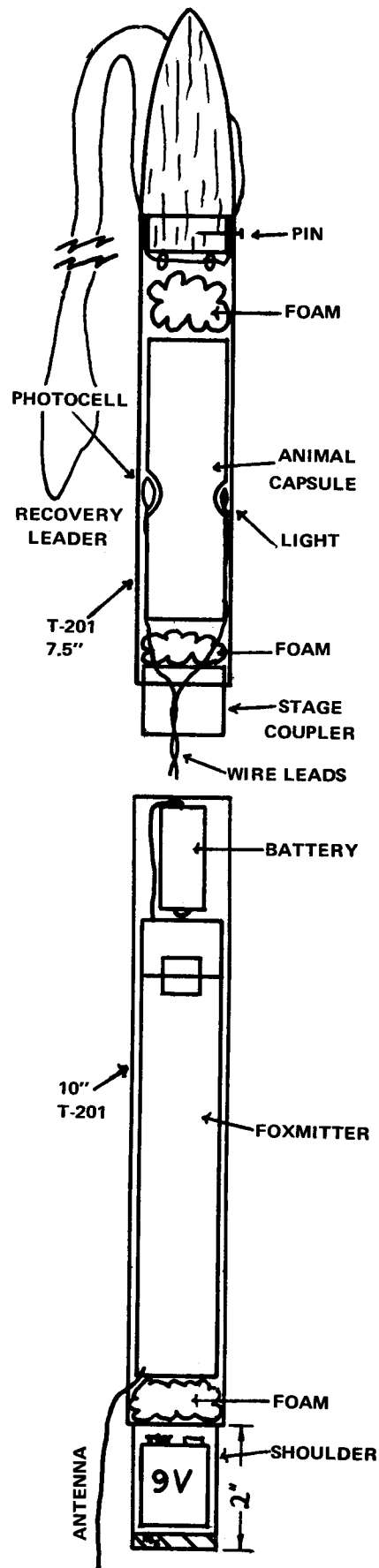

Payload Interior Diagram



BOEING WIND TUNNEL

I have received a fair number of letters over the last year and a half from readers desiring information on constructing and instrumenting a wind tunnel to determine the stability, drag, and side force (or lift, in the case of boost/gliders) of their models. What with all the other work our staff has to do to keep *MRM* coming out regularly, we were sitting around wondering how we'd ever find the time to work out and publish a design that would be simple, effective, and within a modeler's budget when the good offices of the Boeing Airplane Company neatly solved our problem for us.

What they did was to send us the plans for a small wind tunnel they had worked up in response to the many requests for information they had received from model airplane hobbyists over the years. The tunnel and its associated balance system are primarily intended for testing airfoil sections for model planes, but they will do equally well (with little or no modification) for testing model rockets, fins, B/G wings, and even complete gliders if they are small enough.

The Boeing tunnel is of the "Eiffel", "NPL", or open-circuit variety, drawing in air from the atmosphere through its bellmouth, or entrance cone, and expelling it through a diffuser after it is passed through the test section. The cross-section through the bellmouth and test section is rectan-

gular, with the bellmouth being 16 inches wide and 15½ inches high at its largest point. These dimensions taper down to a width of 10 inches and a height of 7 inches in the test section (the ratio of 7 to 10 is a common one in full-sized, professional tunnels). The contraction ratio of this wind tunnel is therefore 3.54 — not as great as that of some of the modern, ultra-low-turbulence tunnels, but if you run this one in a reasonably large room with no strong drafts its turbulence will probably not be too severe. Aft of the test section, the diffuser transitions smoothly to a circular cross-section of 12 3/4 inches diameter, followed by a 2-inch-long circular propeller shroud. The diffuser transition can be made of sheet metal, such as 22-gage or 24-gage galvanized sheet, according to the methods for making "transition pieces" described in texts on engineering drawing. For the sake of strength, the diffuser should be encased in a rectangular wooden framework as indicated on the drawing. The bellmouth is 12 inches in length, the test section 10 inches, the diffuser 28 inches, and the fan shroud 2 inches, for a total tunnel length of 52 inches.

Boeing's drawing shows a fan mounted on a spindle and driven by a quarter-horsepower motor through a belt-and-pulley system. The means of mounting the fan spindle and the motor are not shown, but

you will have to devise some sort of strut system to mount the spindle at the tunnel centerline without interfering with the rotation of the fan. For best performance the struts should be symmetrically airfoiled and designed like the straightener vanes described in Alan Pope's *Wind-Tunnel Testing* (Second Edition, John Wiley & Sons, New York, 1954). For a fan you may use any automobile or window fan of the proper diameter (12 inches), or you can make one yourself from several two-bladed, 12-inch-diameter model airplane propellers. In general, the more blades your fan has, the higher the test section velocity you will be able to produce. Twelve blades is the practical upper limit, and you should not use a fan with fewer than three blades. Also, the number of mounting struts should not be equal to, or any integral multiple of, the number of fan blades or undesirable velocity fluctuations will be produced by the resulting periodic aerodynamic interference of the blades with the struts. In other words, if you have a 4-bladed fan you should use three mounting struts; if a 6-bladed fan, four mounting struts, etc.

The Boeing tunnel's system for measuring the test section airstream velocity is a manometer which compares the test section static (that is, lateral) pressure to the atmospheric pressure outside the tunnel. The static pressure is taken by simply connecting one side of the manometer to a hole drilled in the test-section wall, while the atmospheric pressure is taken by leaving the other end open to the outside air. The formula for converting the manometer reading to velocity is shown on the drawing. And what velocity can this tunnel produce? You can get an idea of this by converting the power of the motor to its equivalent in the movement of air through the test section. One horsepower is equivalent to 550 foot-pounds/second. The power associated with the movement of air of density ρ slugs/cubic foot through a duct of cross-sectional area A square feet at a velocity of V feet/second is

$$P = \rho AV^3 \text{ foot-pounds/second}$$

Conversely, the theoretical velocity attainable in an airstream driven through a duct by a motor of power P foot-pounds/second is

$$V = (P/(\rho A))^{1/3} \text{ feet/second}$$

Now if you use the motor recommended by Boeing, you will have a motor rating of ¼ horsepower, or 137.5 foot-pounds/second. The test section cross-sectional area is 70 square inches, or 0.487 square foot, and the density of sea-level air is 0.002377 slugs/cubic foot. Performing the calculation, we find that V is 49.2 feet per second. This is the theoretical maximum velocity the tunnel can produce. The actual maximum velocity will be considerably less due to fan inefficiencies and losses to friction and turbulence, so consider yourself lucky if you can get more than 40 feet per second with the ¼-horsepower motor recommended. Higher velocities are attainable if you use a more powerful motor which can drive the fan more rapidly, but remember that the air-

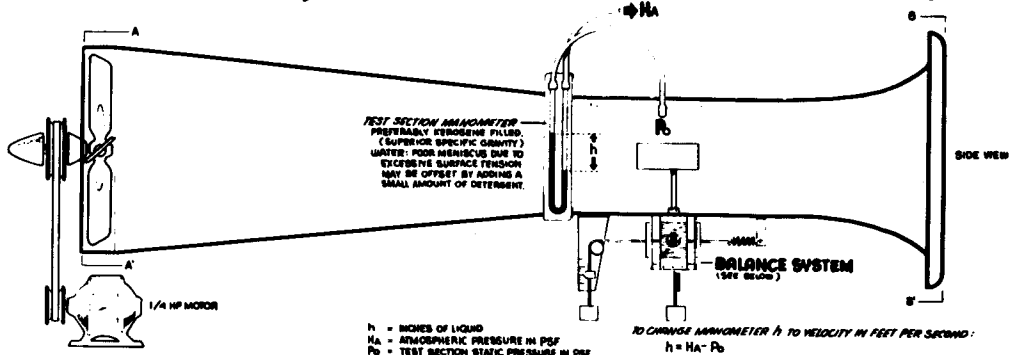
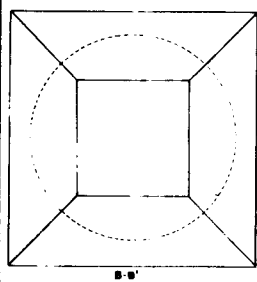
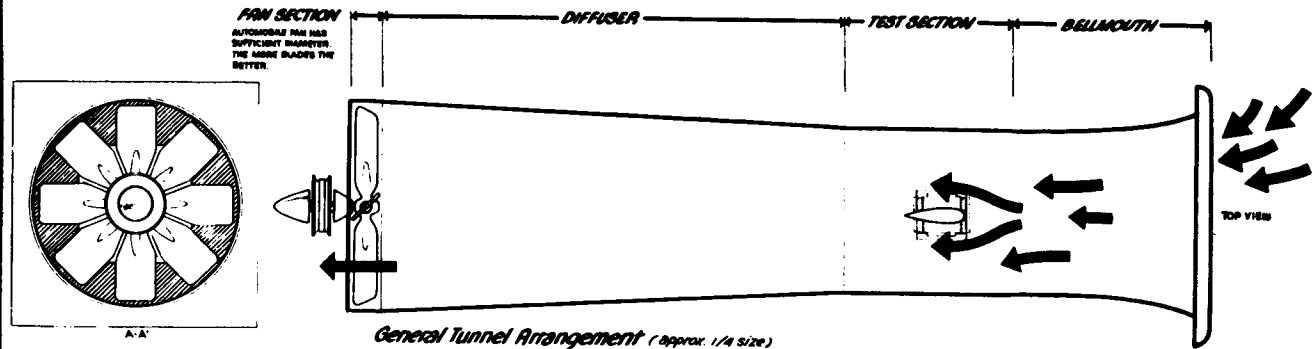

- h = INCHES OF LIQUID
- Ha = ATMOSPHERIC PRESSURE IN PSF
- Po = TEST SECTION STATIC PRESSURE IN PSF
- p = DENSITY OF AIR IN LB SEC²/FT⁴
- v = FREESTREAM VELOCITY IN FT/SEC
- q = FREESTREAM DYNAMIC PRESSURE IN PSF
- R = GAS CONSTANT
- T = ROOM TEMPERATURE IN DEGREES F.
- ρ = POUNDS PER SQ. FT.
- g = ACCELERATION DUE TO GRAVITY

TO CHANGE MANOMETER h TO VELOCITY IN FEET PER SECOND:

$$h = Ha - Po$$

$$Ha - Po \text{ INCHES OF WATER} \times 5.204 = (Ha - Po) \text{ PSF} = (q) \text{ PSF}$$

$$Ha - Po \text{ INCHES OF MERCURY} \times 4.165 = (Ha - Po) \text{ PSF} = (q) \text{ PSF}$$

$$P = \frac{\rho}{g} = \frac{q}{v^2}$$

$$v = \sqrt{\frac{2(Ha - Po)}{\rho}}$$

ER(T) 1715 (460+T) (460+T) ABSOLUTE TEMP.

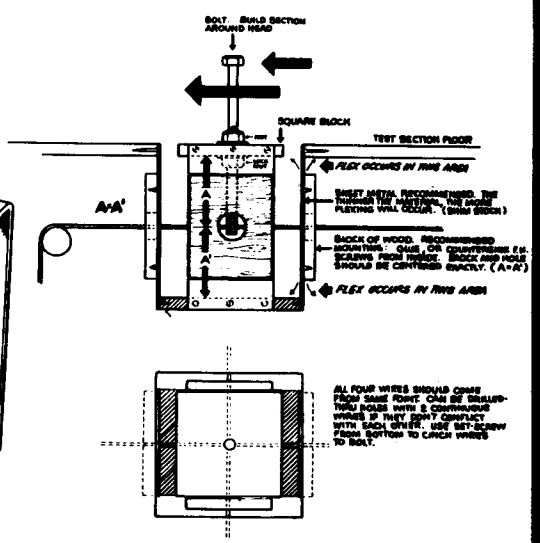
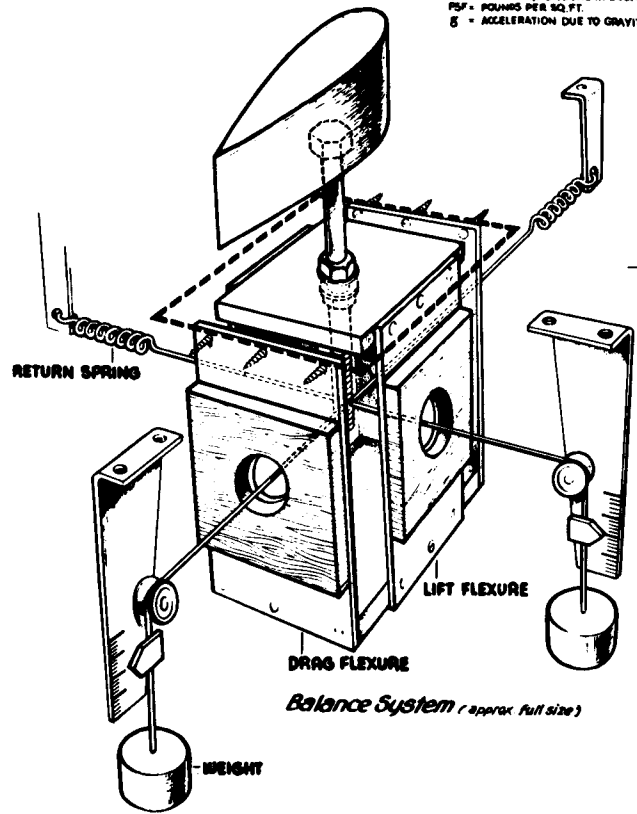
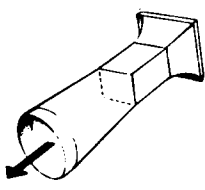

speed increases only as the *cube root* of the motor power. Thus, if you use a ½-horsepower motor you will not be able to get 80 feet/second; in fact you will be lucky to get more than 50.

Large, professional wind tunnels generally feature motors that can be continuously speed-regulated by an electrical control such as a variac. Most model rocketeers will not be able to include this feature on their tunnels because motors capable of such regulation are generally not made in the smaller sizes, and most of those that are require thousands of dollars of special equipment to effect speed control. Series-wound motors (also called AC/DC universal motors) that can be simply controlled by a variac (variable autotransformer) or rheostat can sometimes be found in fractional-horsepower sizes, but most are military surplus items that require 24 or 28 volts for full-speed operation, rather than the 115 commonly found in residential outlets, and thus a step-down transformer must also be used. And if such a motor ever needs repair, you probably won't be able to get spare parts for it. All the motors that are cheap, easy to find, and easy to have repaired when necessary (such as motors from window fans, lathes, washing machines, etc.) are of the AC split-phase type. They come in constant speeds such as 1130, 1725, and 3450 RPM. The speed of such a motor cannot be regulated or changed; any attempt to control its speed by varying its supply voltage will rapidly burn the motor out. The only way to get airspeed control with such a motor is incrementally, through multiple-pulley-ratio systems such as those found on lathes. The idea is to get several pulley ratios using pulleys whose diameters add up to the same figure so you can use the same belt for all speeds. By way of example, one builder might use a 2-inch pulley on the motor and a 4-inch pulley on the fan for low speed, two 3-inch pulleys for medium speed, and a 4-inch pulley on the motor with a 2-inch pulley on the fan for high speed. Experiment with pulleys until you get the highest speed of which the tunnel is capable without overloading the motor. A word of caution: **BE CAREFUL WHEN EXPERIMENTING!** Not only can you tear up your hand with a fan, but the fan may fly apart if run too fast. DO NOT stand in the plane of the fan disc when the motor is on. I once

did and almost got a blade through my neck when the fan flew apart.

The most ingenious feature of the Boeing tunnel is its lift/drag balance, which is more or less fully described in the detail drawings. A 3½-inch-square is cut out of the test section floor and the drag flexures, made of some thin metal sheet such as a springy, .010-inch aluminum alloy, are fastened to the fore and aft edges of the hole. The drag flexures are joined at the bottom by a wooden block 3½ inches long but only 2½ inches wide. To the *sides* of this block are fastened the lift (or side force) flexures, which are also made of thin metal sheet but only 2½ inches wide as opposed to 3½ for the drag flexures. The lift flexures extend up to a 2½-inch-square block which occupies the center of the hole in the test section floor. All the flexures are 4½ inches in height. With the airflow off, the balance is set to read zero by balancing the forces due to the return springs by those due to the counterweights. With the airflow on, the aerodynamic forces cause the balance to deflect (up to ½ inch deflection is permitted in any direction) and the lift and drag can be read on the calibrated scales. Or you may find it more accurate to reverse the locations of the springs and counterweights and read the forces by adding weights to re-zero the indicators. While this balance will read lift and drag or side force and drag, it will *not* read corrective moment. If you want corrective moment data you will have to build another balance, such as the one described by Forrest Mims in the July, 1970 MRm.

And there you have it. The Boeing tunnel, an excellent first project for any amateur aerodynamicist, be he model rocketeer or model aviator, is a challenging yet fully operative and reasonably cheap instrument whose construction should be within the abilities and resources of most model rocketeers. If you are at all interested in aerodynamic testing, I recommend this little gem without reservation. Try one! And don't stop there. Take data, use it for science projects or R&D studies, modify it with honeycombs and a stilling chamber to test the effects on turbulence and airspeed. The variety of experiments and modifications possible with this simple device is practically limitless — and the thing is fun, too!



NARAM-12 — August 16-21, 1970, the 12th National Model Rocket Championships, open to all NAR members. Events: Class 1 Parachute Duration, Design Efficiency, Sparrow B/G, Scale, Swift B/G, Space Systems, Egg Lofting, Open Spot Landing, R&D. Site: Astroworld, Houston, Texas. Contact: by July 6, 1970, Contest Director, Richard Sipes, 5012 60th Ave., Bladensburg, MD 20710.

New Jersey Mini-Convention — September, 1970, the one day long convention will include discussion groups, a flight session, and post flight analysis. Open to all rocketeers. Contact: Mini-Convention, c/o Bob Mullane, 34 Sixth Street, Harrison, New Jersey 07029.

TRI-SEC II — September 11-13, 1970, a regional meet for NAR members from Delaware, Maryland, Pennsylvania, New Jersey, Connecticut, and New York, sponsored by Gemini MRS. Events: Class 0 Altitude, Open Payload, Scale, Eagle B/G, and Class 1 PD. Site: Sand Pits Launch Facility, New Castle, Del. Contest Director: Scott Brown, 204 Delaware St., New Castle, Del. 19720.

MITSEC-1 — September 14, 1970, MIT Section meet open only to section members. Events: Hornet B/G (limited to ¼A engines), Class 1 Streamer Duration if included in new Pink Book (limited to ¼A engines), Class 1 Parachute Duration (limited to ½A engines). Site: MIT Briggs Field, Cambridge, Mass.

WESNAM-2 — October 4, 1970. Area meet open to NAR members from Mass., N.H., and Maine. Events: Hawk B/G, Egg Loft (20 N-sec limit), Class 2 Parachute Duration, Plastic Model (if this event is eliminated from the new "Pink Book", Streamer Spot Landing will be substituted). Site: Bridgewater, Mass. Contact: Trip Barber, MITMRS, MIT Branch PO Box 110, Cambridge, Mass. 02139.

**ATTENTION
CONTEST DIRECTORS**
Mail notices of your contests at least 90 days in advance for listing in Model Rocketry's "Modroc Calendar":
Modroc Calendar
Box 214
Astor Station
Boston, Mass. 02123

Now Available From
Spacemaster Enterprises

"VOSTOK"
by MPC

ONLY \$4.50 postpaid.

P.O. BOX 424
WILLOUGHBY, OHIO
DEPT. MR 44094

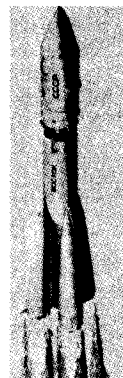

Lunar Orbiter Photo Book Released

Photographs providing nearly complete coverage of the lunar surface are presented in "The Moon as Viewed by Lunar Orbiter," a new publication of the National Aeronautics and Space Administration. In addition to conventional photographs, the book also contains four full-page stereoscopic pictures. Using spectacles provided with the book to look at these pictures, the reader can see into lunar craters and valleys. These pictures show Aristarchus, Schroter's Valley, Rimae Parry and the Tobias Mayer Dome. The pictures were chosen from the 3,100 taken on five Orbiter missions preparatory to the Apollo flights. Index maps indicate the area shown in each view.

The 152-page book, NASA SP-200, may be purchased for \$7.75 from the Superintendent of Documents, U.S. Government Printing Office, Washington, D.C. 20402.

NEWS NOTES

Oklahoma Hobby Fair

The second annual Model Hobby Fair will be held in Oklahoma City, Okla., October 17th and 18th, sponsored again by the Oklahoma Science and Arts Foundation. Last year's first Fair proved to be one of the most popular in the Southwest, drawing large and enthusiastic crowds of people from all over the state and modelers and manufacturers from all over the nation. The Oklahoma Science and Arts Foundation which has the complete cooperation of all the modeling clubs in the area, promises to equal if not excel the previous Fair with all sorts of activities, prizes and special events.

The Fair will again be held on the Oklahoma State Fairgrounds in the Women's Building which has several adjacent acres of open ground for flying demonstrations and outdoor activities. Display areas within the building will be provided for all modelers who wish to bring their planes, boats, cars, model rockets, or what have you. Added this year to the official list are ham radios, model railroads and treasure hunting with both manufacturers and enthusiasts in these fields welcome to exhibit or

(From the Editor, cont.)

using a closed-breech launcher, he stands a better chance of winning than any of the other contestants flying without the benefit of such a launcher. Is this an *unfair* advantage?

Certainly not! To be unfair, we would have to allow one contestant to use the closed-breech launcher while prohibiting another contestant from employing one. So what happens? After a while, every rocketeer who wants to even have a chance to win in competition is forced to go out and build a closed-breech launcher. Is this good, or is it bad?

What happened when the front-engine B/G was developed? It revolutionized competition! For awhile, front and rear engine B/G's were both seen in competition. But eventually everyone noticed that the front-engine B/G's were winning the trophies... *they were superior gliders*. Perhaps we should have called for a ban on front-engine B/G's because they were causing a change in the nature of the competition. Shortly thereafter the pop-pod was developed, and after a few years of effort at perfecting pop-pod designs, it now seems to have replaced the fixed front-engine pod on most competition B/G's. In the area of boost/gliders it's clear that the choice was to allow the new development to revolutionize the nature of the competition. But what will happen when the radio-controlled B/G is perfected? Will it

Rocket Supplies FREE CATALOG

JOHNSTON
AEROSPACE
INDUSTRIES
2608 Kensington Rd.
East Meadow, N.Y. 11554

be allowed in normal B/G competition (and will the nature of the competition change from construction of a good glider to development of good RC flying techniques)... or will a separate event be established for these gliders?

What will happen, quite probably, is that those changes which are regarded as minor (such as the front-engine B/G) will be permitted, but the dramatic changes will *cause the creation of new competition events*. And furthermore, if the events we have now are fun to fly *they should be retained*. If a new and radical development comes along, its proper place is as a new event. If the old event declines in popularity, it can easily be dropped. If the new event is not popular, it can be replaced. So what of towers... and closed-breech launchers, the two problems we currently face? The question should be decided by the sentiment of the modelers who are currently flying in competition. Do you want to compete with (or against) a rocketeer with a tower or with a breech launcher? If most rocketeers like the devices, they should be allowed. If not, they can easily be banned. (In fact, they can be banned at individual contests merely by edict of the Contest Director.)

On the East Coast the sentiment seems to be quite clear that towers are going to be accepted in competition. They are not too hard to build, and they are becoming quite popular even at the smaller meets. Thus far, there doesn't seem to have been too much reaction to towers from the central and western areas. On closed-breech launchers, the reaction has been largely negative. The Washington State Model Rocket Association, despite some protests, has banned the use of closed-breech launchers in competition. Thus far, with the exception of one closed-breech launcher employed at NARAM-11, I've seen no use of them at NAR competitions. We'll need some more experience with them before the large scale modelers' sentiment can be accurately measured.

In any case, the decision either to *ban* or to *accept* any revolutionary new concept in competition will seriously affect the nature of future competition in that event. It is a matter deserving serious consideration of every competition modeler, not just the Contest Board. And furthermore, it's a question which will be decided based on the reaction rocketeers have to these new devices at the meets at which they are introduced.

Reader Design Page

This month's Reader Design is the *Wasp-II*, a two-stage sport rocket, submitted by Tony Barrett of Mansfield, Ohio. The upper-stage stands $17\frac{1}{2}$ " long, and is suitable, if used without the booster, as a parachute duration rocket.

Parts List

- 1 Body Tube BT-55V
- 1 Nose Cone BNC-55AC
- 2 Engine Mount EH-2055
- $\frac{3}{32}$ " and $\frac{1}{8}$ " Balsa Sheet, Glue, Paint, Etc. (All parts available from Estes Industries.)

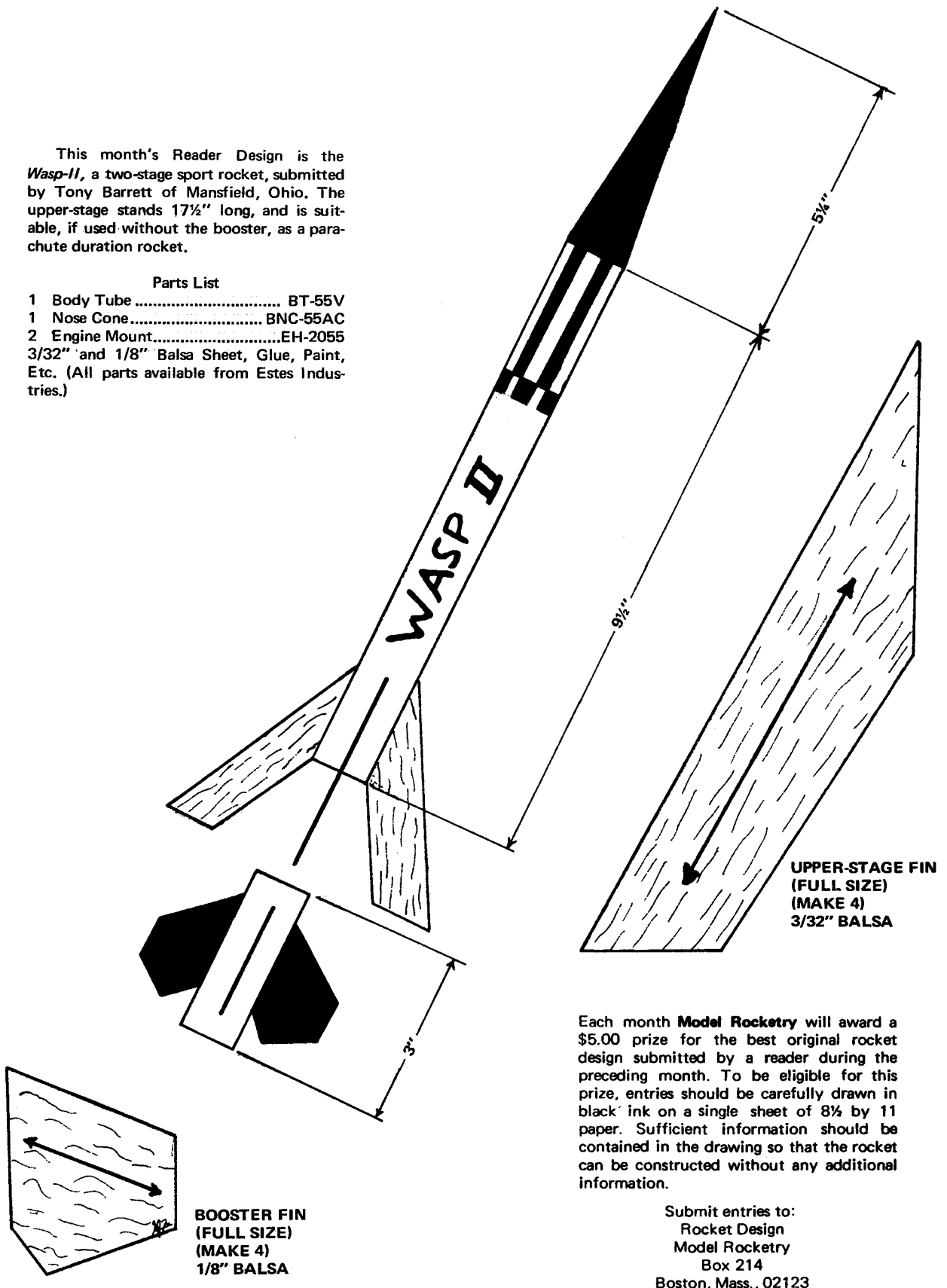

Each month **Model Rocketry** will award a \$5.00 prize for the best original rocket design submitted by a reader during the preceding month. To be eligible for this prize, entries should be carefully drawn in black ink on a single sheet of $8\frac{1}{2}$ by 11 paper. Sufficient information should be contained in the drawing so that the rocket can be constructed without any additional information.

Submit entries to:
 Rocket Design
 Model Rocketry
 Box 214
 Boston, Mass., 02123

Korolev RD-107 "VOSTOK" Part II

by G. Harry Stine

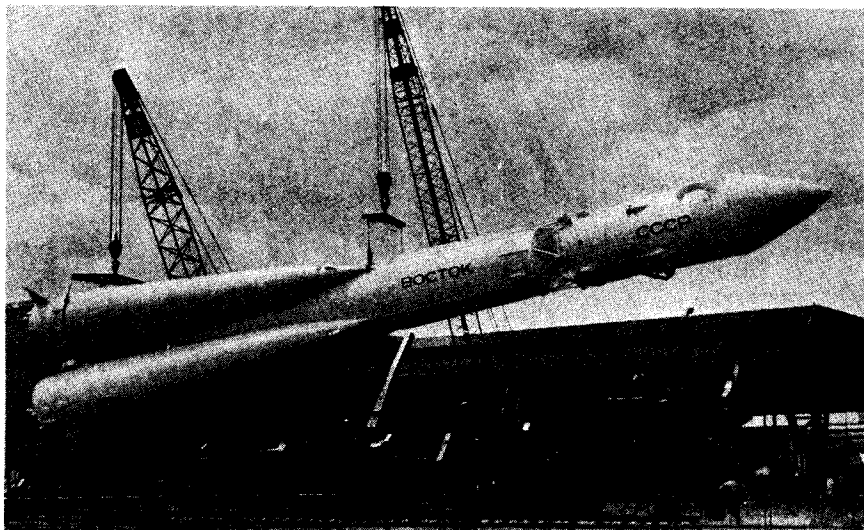

Photo by Michel Tiziou

The Paris full-size display model is loaded into the display cradle. This model was painted white overall, with the lettering "ВОСТОК" and "СССР" in red. Note the arrangement of the interstage adapter.

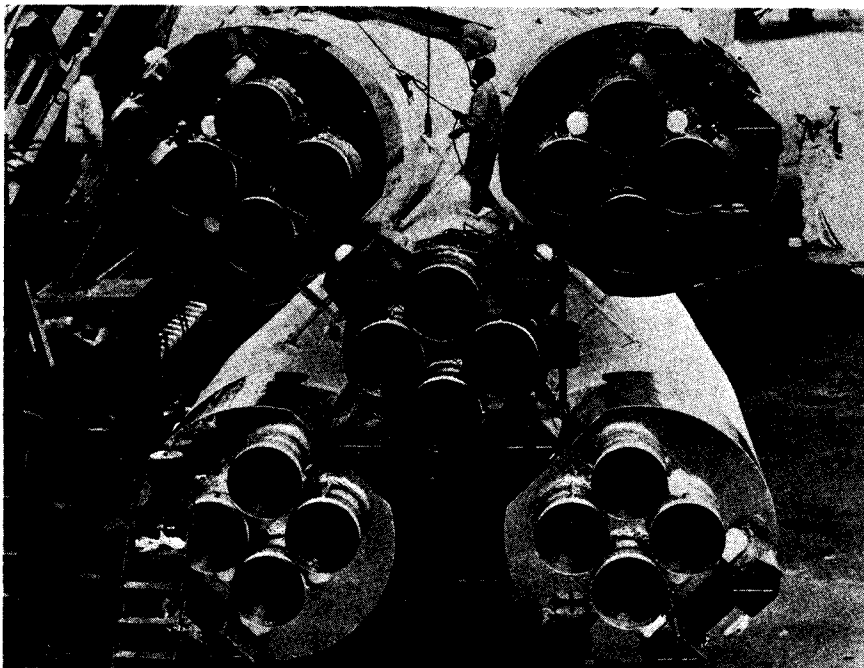

Photo by Michel Tiziou

Rear view shows the arrangement of the nozzles on the Paris display model. Note the tubular bars used to attach the strap-ons to the core.

The RD-107 basic carrier rocket is a parallel-staged booster derived directly from the Soviet SS-6 ICBM. It is powered by five liquid propellant rocket engines utilizing a kerosene-like fuel and liquid oxygen as an oxidizer. Each rocket engine is made up of a cluster of 4 main combustion chambers and either 2 of 4 smaller vernier or steering rocket engine chambers; all chambers of the engine are fed from a single turbo-pump. The main thrust chambers are solidly mounted to the airframe, while the vernier chambers can swivel through two degrees of freedom to provide stabilization and steering.

Guidance system and method is unknown, but is probably radio-inertial.

The RD-107 is assembled horizontally on a rail car and transported to the launch area on the rail car in the horizontal position. The rail car is also the erector which raises the RD-107 to the vertical position over the blast pit of the launch pad. Four counter-weighted support arms swing in to attach to the vehicle at the forward end of each booster, and these arms support the vehicle on the pad.

Pad turn-around time is probably quite short, judging from the fact that Vostok 3 and Vostok 4 — as well as Vostok 5 and Vostok 6 — were launched from what appears to be the same launch pad 24 hours apart on their respective group flights.

Simultaneous ignition of 32 separate thrust chambers preceeding the lift-off of the RD-107 is an engineering feat of no mean proportions, and the exact method of doing this has not been discussed by the Soviets. However, the RD-107 lifts-off as a true parallel-staged vehicle with all 5 rocket engines producing thrust. Total liftoff thrust is 950,000 pounds, increasing to 1,150,000 pounds in vacuum. As thrust builds up on the pad, the weight of the RD-107 comes off the four counter-weighted pad support arms, which swing back to permit the RD-107 to leave.

At an altitude of approximately 185,000 feet some 130 seconds after liftoff, the RD-107 has achieved a velocity of about 6600 feet-per-second and the propellants in the 4 strap-on boosters are exhausted. Explosive bolts sever the connections between the boosters and the core at the forward and aft booster attach points, and the boosters fall away from the still-accelerating core.

The core vehicle continues to be accelerated until propellant exhaustion or propellant cutoff 332 seconds after liftoff.

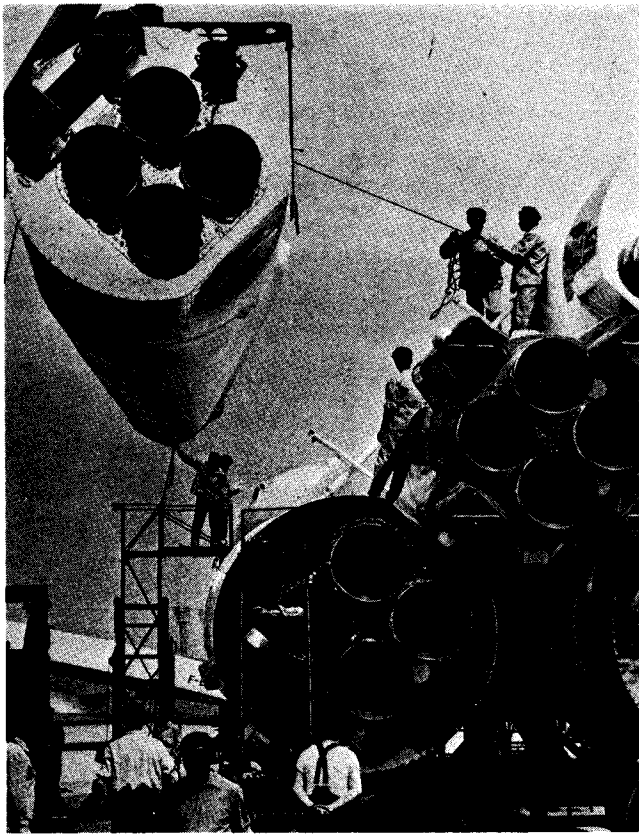

Photo by Michel Tiziou

Workmen attach a strap-on to the RD-107 core during assembly of the Paris Air Show display model. Note the rivet detail around the nozzles as well as the shape of the forward strap-on attachment point.

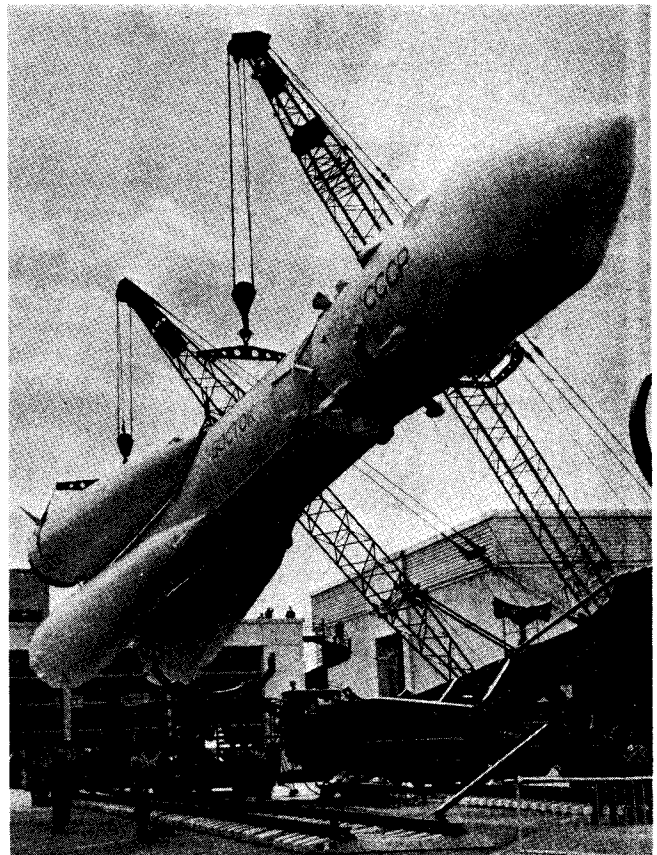

Photo by Michel Tiziou

The assembled "Vostok" is swung into place at the 1967 Paris Air Show. Note the shapes of the various attachments to the upper stage and space craft.

The early RD-107's had no top stage and thus could put only 3000 pounds of payload plus the 8000-pound core vehicle into orbit. The RD-107A with the RD-119 upper stage using liquid oxygen and dimethylhydrazine was attached to the RD-107 core by open trusswork, permitting the RD-119 engine to be ignited upon core burnout using "fire-in-the-hole" technique similar to the Titan-II. The RD-119 thrusts the second stage into orbit, permitting an orbital payload of some 10,400 pounds. The RD-119 is a re-startable rocket engine that permits the second stage to use a parking orbit for interplanetary or lunar shots; when the RD-119 stage is so used, it is called an "orbital platform" or "nositel sputnik."

No attempt was made to recover the first three Sputniks launched by the RD-107. In a like manner, no recovery attempt is made for the RD-119 stage for orbital flights or interplanetary shots. The recovery sequence of the Vostok spacecraft has been detailed elsewhere.

Weights: (estimated)

Propellants in 4 boosters:	375,000 lb.
Propellants in sustainer:	240,000 lb.
Propellants in top stage:	32,000 lb.
Total Propellants:	647,000 lb.

Vostok spacecraft (including 3400-pound second stage):	10,400 lb.
Empty core vehicle:	8,000 lb.
Empty boosters:	53,400 lb.
TOTAL Empty weight:	71,800 lb.
Lift-off weight:	718,800 lb.

(Weight data from BIS "Spaceflight" magazine, "Russian Rocketry At Paris," A.V. Cleaver, Vol. 9, No. 10, October 1967, pp. 330-336.)

Propulsion:

RD-107 ROCKET ENGINE:

Type: Liquid propellant, multi-chamber, turbo-pump fed.
 Vacuum thrust: 102 t (228,480 pounds)
 Vacuum specific impulse: 314 N-sec/N
 Chamber pressure: 60 atmospheres (885 pounds per square inch)
 Propellants: Liquid oxygen and hydrocarbon
 Configuration: Four main thrust chambers, regeneratively-cooled, and two vernier chambers, regeneratively-cooled (4 vernier chambers on RD-108 rocket engine used in core) supplied by single turbo-pump assembly.
 Turbo-pump details: Single-shaft. Double-sided LOX pump. Single-sided fuel pump. Centrifugal type. Driven by gas generator

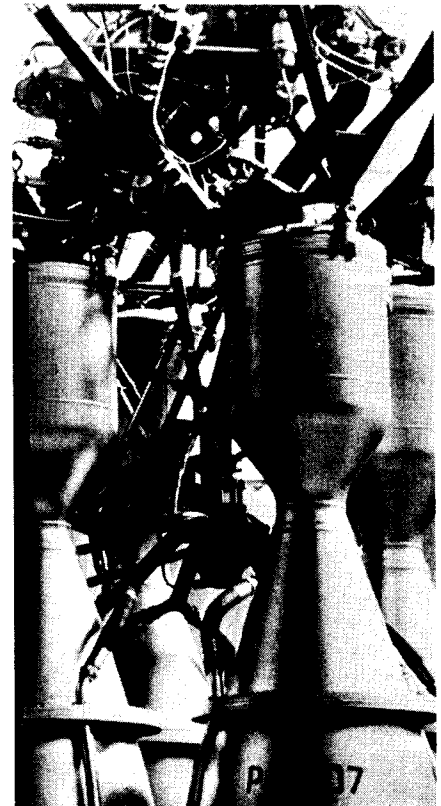

The RD-107 rocket engine .

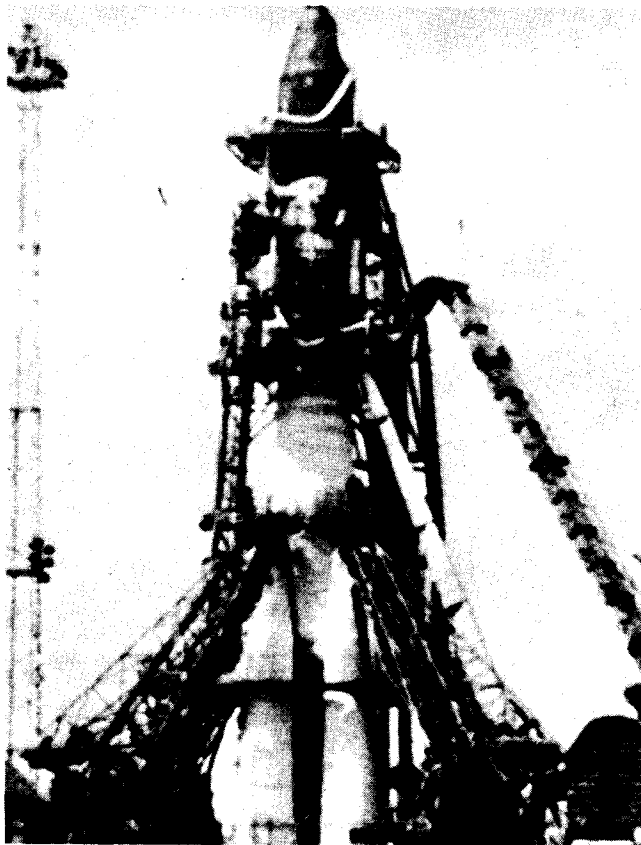

The Korolev RD-107 carrying Vostok-1 on the launch pad at Baykonur Cosmodrome, April 12, 1961 shortly before launch, LOX has been loaded as revealed by the frost on the tanks. Photo taken from the downrange side of the launch complex. (CTK-TASS Photo 252396/6 dated April 12, 1961.)

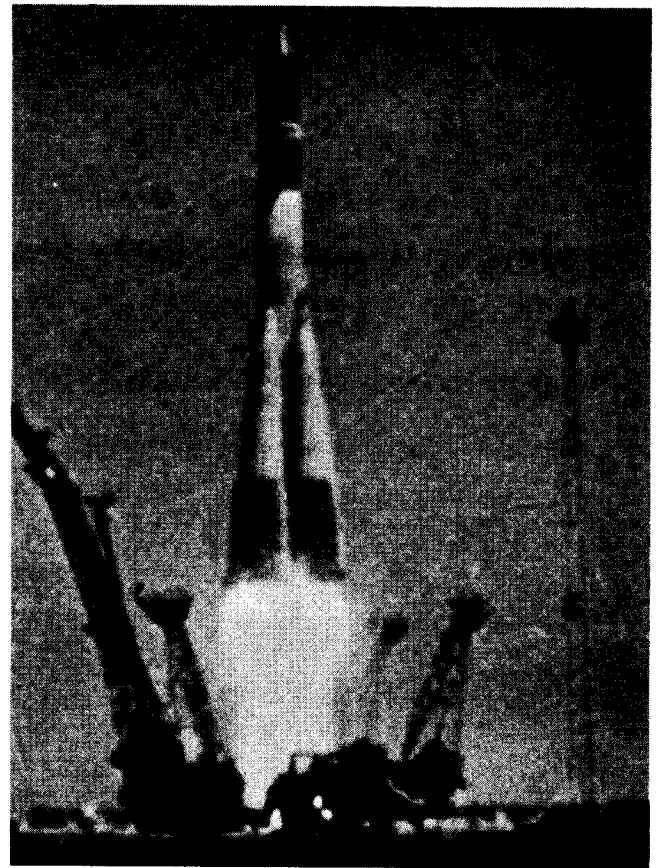

Lift-off of the first manned orbital flight. The RD-107 bearing Vostok-1 and Major Yuri Gagarin rising from the Baykonur launch complex, April 12, 1961. Note the position of the swing-arms as the rocket leaves the pad. (Novosti Press Photo A68-24930.)

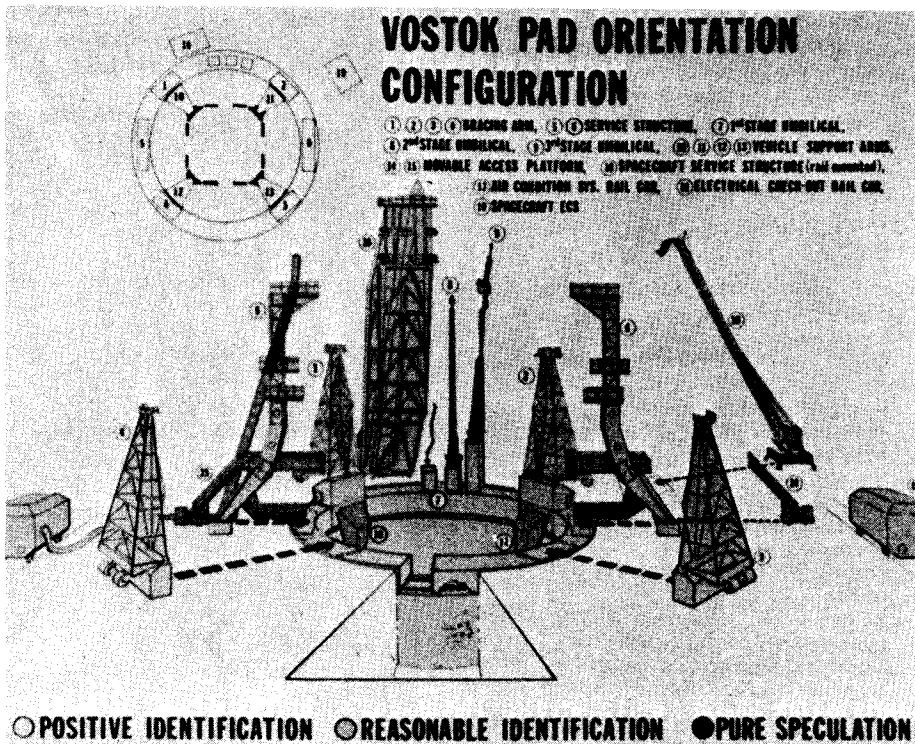

The RD-107 launch complex for the Vostok missions included a number of gantries and work platforms. This drawing was prepared after a careful study of released Soviet photographs of the Baykonur launch complex.

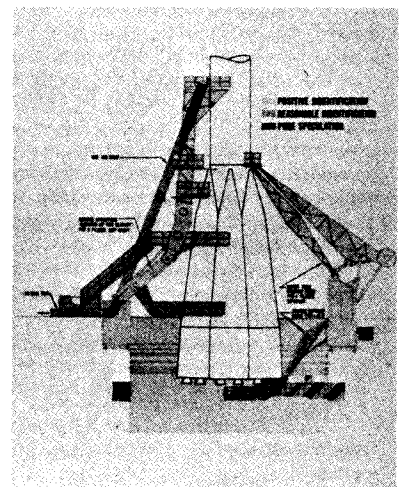

The RD-107 launch complex uses four swing-back arms to hold the vehicle upright, as shown in this cross-section drawing of the launch pad prepared from a study of released Soviet photos.

which is in turn supplied by smaller centrifugal pump. Gas generator apparently driven by decomposition of hydrogen peroxide. Injector design: Single plate injector in each chamber. Welded construction. Thrust chamber materials: External walls apparently steel. Internal chambers walls of high cooper alloy.

RD-119 ROCKET ENGINE:

Type: Single-chamber liquid propellant turbo-pump fed.
Vacuum thrust: 11 t (24,244 pounds)
Vacuum specific impulse: 352 N-sec/N
Chamber pressure: 80 atmospheres (1176 pounds per square inch)
Propellants: Liquid oxygen and dimethyl-hydrazine
Turbo-pump details: Single shaft driven by monopropellant gas generator. Turbine exhaust routed to four swivelling auxiliary nozzels used for attitude control.

Color Data:

PARIS AIR SHOW, 26 May 1967: Flat white overall. Mirror silver nozzles on booster and core engines as well as aft bulkheads of boosters and core. Red lettering. This vehicle is now on display in Moscow.

VOSTOK-1: Color photographs taken from single frames of Soviet color motion pictures of the launch of Vostok-1 indicate a Soviet military-olive semi-flat color for the entire vehicle with silver Vostok re-entry sphere showing through nose shroud. White LOX frost covers LOX tanks of boosters and core and corrugated ring around RD-119 stage.

SPUTNIK-1: Black-and-white photographs from Sovfoto as well as Soviet motion pictures indicate that the first three Sputnik launch vehicles were natural aluminum color overall.

Data sources:

Photographs from Sovfoto, Novosti Press, and the CSSR News Agency CTK.
Photographs from Sovfoto and Novosti Press published in *Aviation Week & Space Technology* magazine and *Space Business Daily* in the USA.
Photographs and data acquired by Norman L. Baker, Publisher, *Space Business Daily*.
Drawings and photographs published in *Skrzdlata Polska*, 2 July 1967.
Data displayed by USSR at Paris as reported in *Spaceflight*, Vol. 9, No. 10, October 1967, "Russian Rocketry At Paris," by A.V. Cleaver, pp. 330 et seq.
Russian drawing appearing in *Aviation Week & Space Technology*, June 12, 1967.
General historical information and references are reported in "How the Soviets Did It In Space," by G.H. Stine, *ANALOG* magazine, August 1968; "The Truth About the Russian Space Program," by G.H. Stine, *American Aircraft Modeler* magazine, July 1968.
Flight history taken from "Soviet Space Log," Space Publications, Inc., Washington, D.C., 1967

RD-107 "VOSTOK"

SOVIET SPACE CARRIER ROCKET FLIGHT HISTORY Unmanned program

August 30, 1957: Department of Defense (U.S.) announced 4 to 6 Soviet ICBM tests during Spring 1957.
October 4, 1957: Orbited Sputnik-I, 184 pounds of instruments. 8000 pounds in orbit. 142 x 588 miles, 65° inclination. Down January 4, 1958.
November 3, 1957: Orbited Sputnik-II, 1,120 pounds. 8000 pounds in orbit. 140 x 1038 miles. 65° inclination. Down April 4, 1958.
May 15, 1958: Sputnik-III in orbit, 2925 pounds. 7000 pounds orbited. 135 x 1167 miles. 65.3° inclination. Down May 6, 1960.
January 2, 1959: Launched Lunik-I into solar orbit. 3245-pound capsule, 800 pounds of instrumentation.
September 12, 1959: Launched Lunik-II to lunar impact. 858.4 pounds of instruments on moon.
October 4, 1959: Launched Lunik-III to lunar orbit for photography of backside of Moon. 614-pound spacecraft. 3423-pound empty stage with 345 pounds of instruments aboard.
February 12, 1961: Sputnik-V orbited. 1419-pound Venus probe into 115 x 155 mile parking orbit.
September 1, 1962: Orbited Venus-I. Failed in parking orbit.
November 1, 1962: Orbited Mars-I, 1980 pounds.
January 4, 1963: Orbited 3080-pound un-named spacecraft which failed in parking orbit.
April 2, 1963: Launched Luna-4, 3136-pound soft-lander, failed.
March 12, 1964: Launched Kosmos-60, 3200-pound lunar soft-lander, failed in parking orbit.
May 9, 1965: Launched Luna-5, 3255 pounds, impacted on Moon.
June 8, 1965: Launched Luna-6, 3180 pounds, missed lunar impact.
June 18, 1965: Launched Zond-3, 2000 pounds, lunar photographic orbiter, 25 photos of lunar farside.
October 4, 1965: Launched Luna-7, 3321 pounds, impact on Moon.
December 3, 1965: Launched Luna-8, 3422 pounds, impact on Moon.
January 31, 1966: Launched Luna-9, 3491 pounds, soft-landed on Moon. 27 photos returned.
March 1, 1966: Launched Kosmos-111, 3500 pounds, lunar shot failed in parking orbit.
March 31, 1966: Launched Luna-10, 3588 pounds, orbited Moon.
August 24, 1966: Launched Luna-11, 3616 pounds, orbited Moon.
October 22, 1966: Launched Luna-12, 3600 pounds, returned photos from lunar orbit.
December 21, 1966: Launched Luna-13, 3600 pounds, soft-landed on Moon, returned photos.

(VEHICLE STILL IN USE)

Manned program

May 15, 1960: Launched Spacecraft-I, 10,008 pounds. Recovery failed. Still in orbit.
August 19, 1960: Launched Spacecraft-II, 10,120 pounds, 2 dogs, rats, mice, flies, plants, seeds, fungus, etc. 190 x 211 miles. 64.57° inclination. Recovered 7 miles from target on August 20, 1960.
December 1, 1960: Launched Spacecraft-III, 10,060 lb. Vostok, 117 x 165 miles, 65° inclination. Recovered December 2, 1960.
February 4, 1961: Orbited Sputnik-IV, 14,292-pound Vostok, 138 x 203 miles, 64° inclination. Down February 26, 1961.
March 9, 1961: Orbited Spacecraft-IV, 10,340-pound Vostok with dog. 115 x 155 miles. Recovered March 9, 1961.
March 25, 1961: Orbited Spacecraft-V, 10,330-pound Vostok, 111 x 150 miles, 65° inclination with dog aboard. Recovered.
April 12, 1961: Orbited Vostok 1 with Major Yuri Gagarin aboard. 108 x 187 miles. 65° inclination. Recovered after 1 orbit. First manned orbital flight.
August 6, 1961: Orbited Vostok 2 with Major German Titov aboard. 110 x 115 miles. 65° inclination. Recovered after 17 orbits.
August 11, 1962: Orbited Vostok 3 with Nikolayev aboard. 105 x 156 miles. 65° inclination. Recovered after 64 orbits.
August 12, 1962: Orbited Vostok 4 with Popovich aboard. 111 x 158 miles. 65° inclination. Recovered after 48 orbits.
June 14, 1963: Orbited Vostok 5 with Bykovskiy aboard.
June 16, 1963: Orbited Vostok 6 with Valentina Treshkova aboard.

Automatic Computation for Rocketeers

by Charles Andres

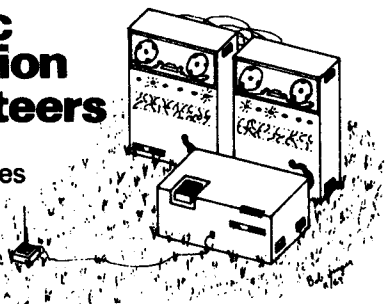

In the ensuing months since this column began, there has been a large number of people who have written to *Model Rocketry* or myself regarding the computer programs published herein. Most of those comments concerning the programs themselves have come from those people who have tried running them on their computers and have had to change something in order to have it be accepted and run successfully. Although some of the comments have concerned typographical errors (which the computer will always find) most have been concerned with adapting the published programs to their own individual computers. Since every computer system — especially the larger ones — is at least slightly different, even when identical software is in question, every computer programmer will run into some minor problems with his particular computer. Fortunately, many of the people have written in telling of the differences they have come across. This is extremely useful to those persons who might be working with software which is similar to that mentioned by others but different from that initially presented in this column. Thus, anyone who has attempted to program these programs in their computer who have either run into difficulty or have had to make major changes in their versions, is encouraged to submit the results so that more computer-oriented rocketeers may benefit from their findings. This seems to be becoming an active branch of model rocketry, and any ideas or new programs are more than welcome.

Unfortunately, technical and typographical errors have slipped in to some of the articles, but as long as they are recognized and publicized, their influence can be diminished. Aside from the small typographical errors which have slipped into the programs, there have been two major errors — one being pointed out by Doug Malewicki and the other coming from my interpretation of George Caporaso's altitude equations.

Doug Malewicki has done an extensive analysis of my February article and in reply I can only say that we learn by correcting our mistakes. The most valid point made by Doug, which seems to have become a rule of thumb in some parts of the technical area of model rocketry: *Don't believe anything you read even if it is surrounded by fancy calculus equations or computer calculations until you have*

checked its validity. Unfortunately, we all have to assume *some* things as true, so when myths or misquotations are found, they should be made known so that they can be corrected. Henceforth, I am going to *triple* check my sources in future columns and make clear which points are not verified. This should go a long way to reducing errors. Now if everyone else would do likewise . . .

Doug asked me to reexamine the V-2 data presented in February. I have researched the matter and have made the following observations. First, if one takes my V-2 example with a liftoff weight of 1.97 ounces and a drag form factor of 1.05 (from Estes TR-10 Report) one finds that my V-2 example powered with an A 8-3 will travel, according to the Malewicki graph in Centuri's TIR-100, to a total altitude of 210 feet. Using the computer and a drag coefficient of .75 and identical parameters, I found that a value of 224 feet was predicted. I flew the V-2, tracked it with two Centuri theodolites and a 900 foot baseline and computed an average height of 225 feet. Going back to the Malewicki Report, TIR-100, I calculated what the C_dA form factor would have to be for a 1.97 ounce rocket to reach 225 feet. The C_dA was computed to be .82 square inches, and the resultant drag coefficient on a BT-55 (TR-10 Graph #1) was .6, which is a little low for a V-2, but not out of the question. Then, I went back to my original V-2 calculations made a good deal earlier and read: Total Altitude: 370 feet! I then realized that I had made these calculations on the old Estes TR-10 graphs just as Doug had suspected! One will notice, however, that these graphs are not marked as complying with either new engines or old ones, since they are merely marked 1/2A, A, B, etc. I also remembered that I had received my copy of TR-10 *after* the metric changeover had taken place, and since the charts were not marked, I forgot about it, a sin never to be repeated! But where had the 370 foot altitude come from? Redoing the necessary preliminary calculations, I could find no error. But when I carefully marked off the coasting altitude on Graph #8, I found the error. I had misread the 200 foot level for the 300 foot mark on the graph since the digits are *less* than 1 mm high and slightly blurred. Thus total altitude worked out to be 270 feet which is only 10 feet higher than Doug's calculation on the TR-10, a *negligible difference* when dealing with the tiny Estes Graphs.

Checking back over the rest of my Malewicki equations, I found them to be accurate — for the old Estes engines. Since every one of these was made invalid when the changeover came, it was no wonder that the February Malewicki computations had been so far off. Thus, I redid the calculations on the newer easy-to-read Centuri report, TIR-100. The results can be seen in Figure 1. *In several cases, the Malewicki computations prove to be more accurate than the computer results, and in all cases, none of the predictions vary by a great deal.* This was very encouraging, since both systems can be considered equally valid.

One of the advantages which shows the real beauty of the computer program is that any statement can be changed and be replaced, omitted entirely, or repeated any time the programmer

Figure 1

NEW REVISED COMPUTER / MALEWICKI ALTITUDE COMPARISONS

ROCKET	Payloader	Excalibur	Aerobee 300	Arcon	Starlight	Excalibur	Drifter	V-2
ENGINE	B 4-4	1/2A 6-2	C 6-5	1/2A 6-2	A 8-3	A 8-3	1/2A 6-2	A 8-3
BODY TUBE	BT-20	#7 Series	BT-50	BT-20	BT-55	#7	BT-50	BT-55
DIAMETER	.736"	.759"	.976"	.736"	.976"	.759"	.976"	1.325"
FORM FACTOR C_{DA}	.300 sq. in.	.275 sq. in.	.505 sq. in.	.300 sq. in.	.60	.30	.57	1.050
LIFTOFF WEIGHT	1.23 oz.	.934 oz.	1.76 oz.	.962 oz.	2.57 oz.	.974 oz.	1.53 oz.	1.84 oz.
BURNOUT WEIGHT	.933 oz.	.879 oz.	1.32 oz.	.907 oz.	2.43 oz.	.828 oz.	1.47 oz.	1.69 oz.
DRAG COEFFICIENT	.70	.60	.75	.70	.80	.60	.75	.75
BURN TIME	1.20 sec	.20 sec	1.70 sec	.20 sec	.42 sec	.42 sec	.20 sec	.42 sec
AVERAGE THRUST	14.38 oz.	21.57 oz.	21.57 oz.	21.57 oz.	28.76 oz.	28.76 oz.	21.57 oz.	28.76 oz.
PROPELLANT WT.	.2937 oz.	.0660 oz.	.4396 oz.	.0550 oz.	.1468 oz.	.1468 oz.	.0650 oz.	.1468 oz.
1/2 PROP. WT.	.1468 oz.	.0275 oz.	.2198 oz.	.0275 oz.	.0734 oz.	.0734 oz.	.0275 oz.	.0734 oz.
BALLISTIC CO. DURING THRUST	3.61	3.30	3.06	3.13	4.21	3.03	2.62	1.68
BALLISTIC CO. DURING COASTING	3.11	3.19	2.61	3.02	4.05	2.76	2.58	1.609
Computer Results								
BURNOUT ALTITUDE	268 ft	15 ft	468 ft	14 ft	30 ft	67 ft	9 ft	43 ft
BURNOUT VELOCITY	380 ft/sec	148 ft/sec	414 ft/sec	143 ft/sec	140 ft/sec	303 ft/sec	86 ft/sec	191 ft/sec
COAST ALTITUDE	653 ft	233 ft	594 ft	212 ft	229 ft	533 ft	96 ft	246 ft
COAST TIME	5.33 sec	3.58 sec	4.92 sec	3.40 sec	3.6 sec	4.97 sec	2.36 sec	3.45 sec
TOTAL TIME	6.53 sec	3.78 sec	5.62 sec	3.60 sec	4.02 sec	5.39 sec	2.56 sec	3.87 sec
Malewicki Results								
MAXIMUM ALTITUDE	1020 ft	260 ft	1200 ft	250 ft	157 ft	580 ft	105 ft	210 ft
COAST TIME	5.9 sec	3.8 sec	5.6 sec	3.4 sec	2.9 sec	4.95 sec	2.4 sec	3.0 sec
TOTAL TIME	7.1 sec	4.0 sec	7.3 sec	3.6 sec	3.32 sec	5.37 sec	2.6 sec	3.42 sec
TRACKED ALTITUDE	887 ft	186 ft	1060 ft	249 ft	150 ft	567 ft	185 ft	225 ft
COMPUTER DIFF.	+ 35 ft	+ 62 ft	+ 3 ft	-23 ft	+ 109 ft	+ 33 ft	+ 19 ft	+ 63 ft
MALEWICKI DIFF.	+ 133 ft	+ 74 ft	+ 141 ft	-37 ft	+ 7 ft	+ 13 ft	+ 20 ft	+ 15 ft

Figure 2
ACTUAL ALTITUDE VS. TWO COMPUTER RESULTS
WITH AIR DENSITY CONSTANT CHANGED

Rocket	Motor	Tracked Altitude	Comp. Alt. $\rho=0.000154$	Comp. Alt. $\rho=0.0001321$
V-2	A 5-2	228 feet	202 feet	214 feet
V-2	A 5-4	184	201	213
PAYLOADER	1/2A6-4	183	208	217
PAYLOADER	A 5-2	556	517	560

wishes. In the O/S system, one merely has to shuffle the card deck. In using remote typewriters, an update is a simple matter. Thus the corrections which Doug has suggested can be complied with. I followed Caporaso's October 1968 MRM equations to the letter, since he claimed that his results came within +1.5% of the Fehskins-Malewicki solutions. The value for air density I accepted was .000154. Doug has pointed out, however, that the correct value for the air density coefficient is 0.0001321. The air density constant is easily changed in the February program. I have done this, and comparison results are shown in Figure 2.

Doug also commented that larger errors were encountered with high drag rockets. I found that as a general rule high drag vehicles were overestimated as to the altitude they could reach and that low drag models were similarly underestimated. It was found that average rockets with 'A' engines provided the most consistent readings. (This led me to a research project into the effect of the time delay element on model rockets which may be published at a later date. More conclusive results backed up by several dozen flight will be presented along with fairly conclusive answers.) Thus, I will plead guilty to Doug's complaint concerning the blind acceptance of George's altitude calculations, which if modified, still provide an accurate measure of hypothetical rocket altitude.

In the last article, a program for computing multi-staged rocket altitudes was included, which will not yield correct or near-correct values in its present form. In order to make the necessary changes one should follow the update format shown in Figure 3 (This update procedure can only be assumed to be valid for programmers using the IBM 2740/360 combination or similar software.) The update will accomplish several things. First it will change the value of air density to the value recommended by Doug Malewicki. (This should also be done on the altitude program presented in February issue.) Next it will change the equations for upper stage burnout altitude. The original Caporaso equations (April, 1969 MRM) show a "2" under the upper half of equation (6). This is supposed to indicate that the variable tb_2 is to be divided by 2. Gordon Mandell reported that the "2" outside the radical can be used to cancel the missing "2" and thus clean the equation up. This has been shown to have been done in the update. Also, X_2 in the April article is defined to be the altitude gained by the second stage from the instant of second stage ignition to apex. Thus, new equations have been added so that X_2 , the total altitude gained by the second stage is now defined as XB_2 plus XB , the altitude gained during thrusting of the booster. These changes should show a reduction in computed altitude which are otherwise quite inflated.

Next time I'll have two short and simple programs to present, the first of which no one will complain about or deny, but the second may incite a torrent of comments since it is a topic of heated discussion. These two programs compute the center of gravity and the drag coefficient of any rocket.

M.0076 BEGIN ACTIVITY Figure 3
/update stage2(1234)
/change 15,17
K=.0001321*A*CD
K2=.0001321*A2*CD2
K3=.0001321*A3*CD3
/change 28,28
 $XB2 = -XB2A + \sqrt{((XB2A)^2 + K2 * TB2 * (XB2B))}$ /K2
/change 37,37
 $XB3 = -(XB3A) + \sqrt{((XB3A)^2 + K3 * TB3 * (XB3B))}$ /K3
/change 45,46
X2=XB2+XB
X3=XB3+XB2+XB
/end
M.0073 ACTION IN PROGRESS
UPDATE SUCCESSFULLY COMPLETED
M.0076 BEGIN ACTIVITY

Back Issues!!!

TO ORDER, JUST CHECK THE
DESIRED ISSUES:

- November 1968** \$.75
Model Rocket Recovery by Extensible Flexwing . . . High Quality Aerial Photography: Part 1 . . . Calculating Drag Coefficients . . . Scale: MT-135 . . . Project Apollo . . . XR-5C: Three-Stage Cluster . . . The Vertix: A Payload Rocket . . .
- February 1969** \$.75
Zeta: Single-Stage Sport Rocket . . . The Flight of Apollo 8 . . . Non-Vertical Trajectory Analysis . . . The Old Rocketeer: Spotlight on the Manufacturers . . . Cosmic Avenger: A Model for Class E Engines . . . Scale Design: Nike-Deacon . . . Model Rocketry for the Depraved . . .
- March 1969** \$.75
The Old Rocketeer: Saffek's Saturn . . . High Quality Aerial Photography: Part III . . . The Biurificon: Rocket Design . . . Constructing a \$25 Club Launch Panel . . . How to Finish a Model Rocket . . . Scale Design: Genie MB-1 . . . The Dynafora: Single-Stage Sport and Payload Rocket . . .
- April 1969** \$.75
Scale: Arcas . . . Report on Apollo 9 . . . Demonstration Launches . . . R. H. Goddard: Payload Rocket . . . Multistage Altitude Calculations . . . Tower Launching . . . Torsion Wire Experiments . . . The Skyray . . . Chicago Trade Show . . .
- May 1969** \$.75
Staged vs. Cluster Model Rocket Performance . . . The Fra-jyle: Sport Rocket . . . Astroscale Data: The ASP Rocketsonde . . . Transmitter Construction Plans . . . The Infinite Loop: Oddball Design . . . The WRESAT: Australian Satellite . . . Pittsburgh Convention . . . The Hawk: Sport Rocket . . . Closed Breech Launching . . .
- June 1969** \$.75
Ignition Technology . . . Build a Temperature Sensor for Transmitter Use . . . Body Tube Guide . . . The MIT Convention . . . The Candelabra: Oddball Design . . . The Thumba Rocket Range . . . Scale Design: IQSY Tomahawk . . .
- July 1969** \$.75
Soviet Space Program . . . Scale: Astrobee 1500 . . . ECRM Results . . . F Engine Saturn . . . Misfire Alley System . . . The Goliath . . . The Why(7)igion . . . Spin Rate Sensor and Direction Sensor for Rocket Transmitter . . .
- August 1969** \$.75
Radio-Controlled Boost/Gliders . . . A History of Retro-rockets . . . An Accelerometer for Transmitter Use . . . Results from WAMARVA-1 . . . The Dyna-mite . . . Scale: Rohini RH-75 . . . The Old Rocketeer: Flat Cat B/G . . .
- September 1969** \$.75
Color Aerial Photography . . . The Flight of Apollo 11 . . . Astroscale plans: Black Brant III . . . Southwest Model Rocketry Conference . . . Payload Section for the Transmitter . . . Czechoslovakian National Championships . . . Plastic Scale Modeling . . . Radio Controlled Boost/Gliders: Part II . . .
- October 1969** \$.75
Conical Model Rockets . . . Astroscale: Nike-Smoke . . . Fin Test Vehicle . . . Fox-mitter Microphone . . . NARAM-11 Coverage . . . R/C B/G: Part III . . . Japanese Activity . . . Dragbrakes Revisited . . .
- November 1969** \$.75
Scale: Nike-Apache . . . Midwest Regional Report . . . Arcturus: Finless Design . . . Ball-Hagedorn Open Payloader . . . Jupiter-C Conversion . . . Washington State Championship . . . Krushnik Effect . . .
- December 1969** \$.75
Yugoslav Championships . . . Relay Ignition Systems . . . Coefficients . . . The Bumble Bee: Hornet B/G . . . Aerial Photointerpretation . . . Designing with Computers . . . B/G Performance: Part I . . . PVARM Regional Report . . .
- January 1970** \$.75
Return to Green Mountain . . . Tilt-A-Tower . . . B/G Performance . . . MARS-IV Regional Results . . . Retro-Rocket Designs . . . Calculating Drag Coefficients . . . USSR Championships . . . Modrocs in Vietnam . . . Fly the Micron II . . . Pershing 1 Scale Data . . .
- February 1970** \$.75
Ram-Air Guidance . . . Yugoslavian Parachute Duration Design . . . Computer Altitude Calculations . . . Build the Warwick II . . . B/G Performance: Part II . . . Body Tube Construction Techniques . . . Helicopter Recovery Techniques . . . Super-Swift Tandem B/G's . . .
- March 1970** \$.75
Converting the Revell LEM to Flight . . . B/G Performance: Part III . . . Plastic Fin Modifications . . . Parallel Fins for Modrocs . . . Ram-Air Guidance: Part II . . . Fly the Super-Titan . . . D-Engine Flight Performance Charts . . .
- April 1970** \$.75
Modroc UFO's . . . HAD Scale Australian Rocket . . . Trade Show Report . . . Rear Ejection Clip . . . Psionic Control of Modrocs . . . C_g Determination . . . D-Engine Performance: Part II . . . Fly the NARWHAL For Design Efficiency . . .

TO:

Model Rocketry Magazine
Box 214
Boston, Mass. 02123

Name
Address
City State Zip

THE MODEL ROCKETEER

NATIONAL ASSOCIATION OF ROCKETRY, Box 178, McLean, Virginia 22101

Pivot Adjustable Launch Tower

by James S. Barrowman, NAR #6883

The Model Rocketeer is published monthly in *Model Rocketry* magazine by the National Association of Rocketry, Box 178, McLean, Virginia 22101. The National Association of Rocketry, a non-profit educational and charitable organization, is the nationally recognized association for model rocketry in the United States. *Model Rocketry* magazine is sent to all NAR members as a part of their membership privileges. NAR officers and trustees may be written in care of NAR Headquarters. All material intended for publication in *The Model Rocketeer* may be sent directly to the editor.

Officers of the Association

Ellsworth Beetch
Bryant Thompson
John Belkewitch
William Rich
Robert Atwood
James Barrowman
James Kukowski
John Worth
G. Harry Stine
Gerald Gregorek
Leslie Butterworth
A. W. Guill
Albert Kirchner
William Roe

President
Vice-President
Secretary
Treasurer
Section Activities
Publications Comm.
Public Relations
Membership Comm.
Liaison Comm.
Standards & Testing
Trustee
Trustee
Trustee
Honorary Trustee

NAR Contest Board
Richard Sipes
5012 60th Avenue
Bladensburg, Md. 20710

Technical Services
Slot and Wing Hobbies
511 South Century
Rantoul, Ill. 61866

The Model Rocketeer
Carl Kratzer, Editor
320 Thurston Avenue
Ithaca, N.Y. 14850

Leader Admin. Council
Jay Apt, Secretary
40 Woodland Road
Pittsburgh, Pa. 15232

Northeast Div. Mgr.
Jay Apt
40 Woodland Road
Pittsburgh, Pa. 15232

Southland Div. Mgr.
Richard Sipes
5012 60th Avenue
Bladensburg, Md. 20710

Mid-America Div. Mgr.
Manning Butterworth
Route 1
Eagle Lake, Minn. 56024

Pacific Div. Mgr.
Dane Boles
3723 Gilman Rd. #22
El Monte, Cal. 91732

Mountain Div. Mgr.
Mel Severe
8361 Chase Way
Arvada, Colo. 80002

Southwest Div. Mgr.
Forrest McDowall
10058 Laston Street
Houston, Tex. 77055

Tower launchers are as old as model rocketry itself. Early model rocketeers got the idea from the White Sands launch towers used for the Aerobee 150. It was natural that the early tower launchers closely resembled those used for the big rockets. As a glance through the *Handbook of Model Rocketry* will show, those towers looked like fugitives from a crane factory. They were intricate structural affairs that weighed several pounds and were barely portable. Eventually, their large size, weight, and the effort needed to build them made these gantry towers virtually extinct.

Recently, the competitive disadvantages of rod launchers came to light through the wind tunnel work on the effects of launch lug drag, both aerodynamic and on the launch rod. Also, launch rod whip, photographed and observed by many competitors was found to reduce altitude by inducing an initial tip-off angle.

Although I don't know when the first modern launch tower was

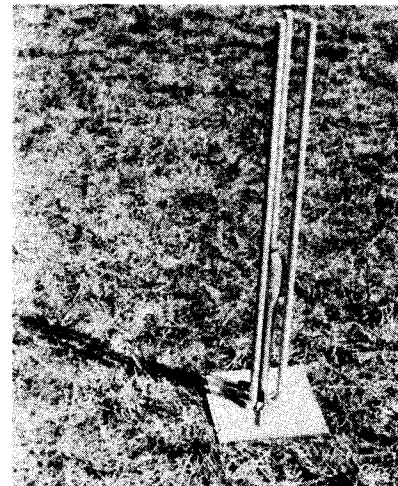
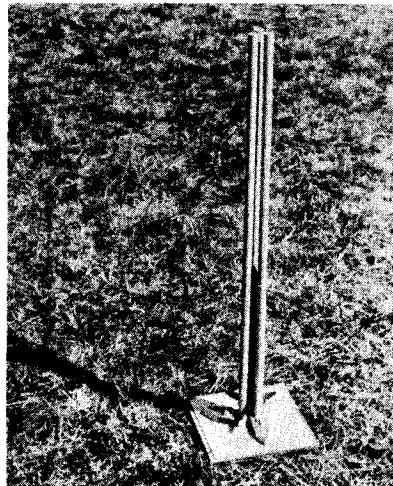

The pivot tower can be used for a thin design efficiency bird . . . then can be quickly adjusted to launch an egg loftter

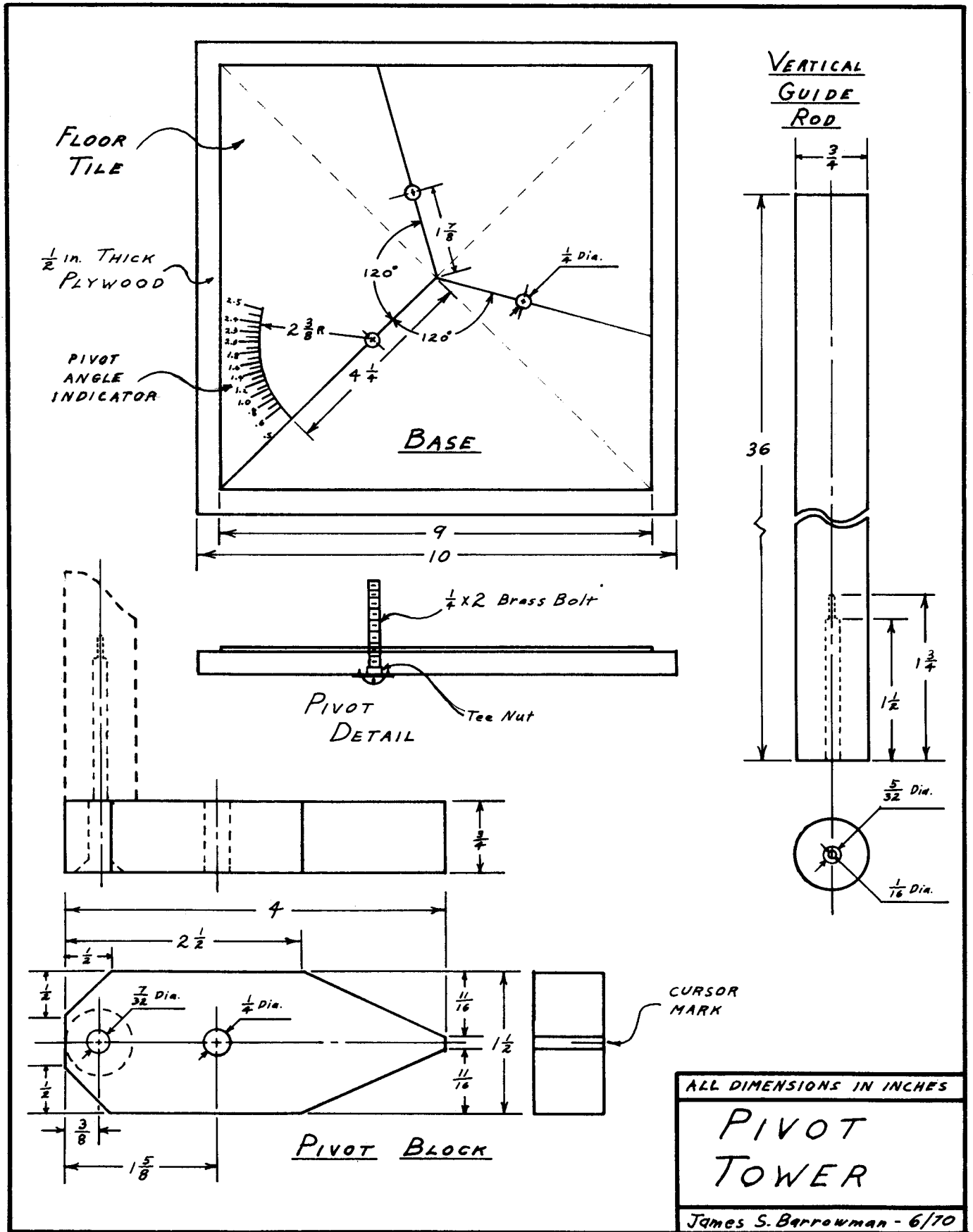

THE MODEL ROCKETEER

actually introduced, the first one I saw was designed and built by Bob Singer. It was first used in major competition at ECRM-3 in April, 1969. Made for a three fin rocket, it consisted of three L-shaped wood members each having a vertical spar about three feet long and a horizontal spar about eight inches long. The short spar of each L-shaped member was attached to a flat wooden base with two nuts and bolts. The three members were spaced around a common center about .8" apart with the short spars radiating out at 120° angles. This formed a three sided vertical guide for a rocket without any launch lug. This design provided a tower launcher with all its competitive advantages but without the bulk or intricate construction of earlier towers.

Bob's idea caught on fast. Throughout the WaMarVa area, each contest saw new launch towers that were variations on his basic theme. Photographs of some of the tower designs were published as part of the article on MARS-IV in the January 1970 issue of MRM. These towers, and most used in more recent contests have one common drawback - the distance between the tower guides couldn't be rapidly and easily adjusted to provide for different diameter rockets.

The pivot tower is designed to provide exactly this capability. As its name implies, this is accomplished by attaching the guide support block to the base with a single pivot bolt, washer, and wing nut. When the three guides are pivoted through the same angle in the same direction, the distance between the guides is increased without changing their equal spacing. The guides can then be locked in the new position by tightening the wing nut. In addition, the attachment by a single bolt and wing nut allows the pivot tower to be quickly dis-assembled for transport.

BUILDING THE THREE FIN PIVOT TOWER

BASE

The base is a ten inch square made of one-half inch thick plywood to which a nine inch square floor tile has been bonded with either epoxy or contact cement.

- Find the center of the base by drawing two intersecting lines between opposite corners of the tile to form an "X".

- Using a protractor, draw two more lines out from the center at 120° on each side of one of the lines between the center and a corner. This forms three equiangular baselines on which the pivots will be mounted.

- Measure and mark 1-7/8 inches out from the center on each of the baselines.

- Drill a one-quarter inch hole at each of the marks made in the above step.

- On the bottom of the base, hammer a tee nut into each of the holes.

- Screw a 1/4" x 2" brass bolt up through the base such that the head of the bolt is tightened against the bottom of the tee nut.

- Using a protractor, lay out three pivot angle indicators like the one shown on the drawing according to the following table.

Rocket dia. (in.)	Pivot angle (deg)
0.5	0.0
0.6	9.5
0.7	13.7
0.8	17.2
0.9	20.2
1.0	23.0
1.1	25.7
1.2	28.2
1.3	30.7
1.4	33.1
1.5	35.5
1.6	37.9
1.7	40.2
1.9	44.8
2.0	47.1
2.1	49.4
2.2	51.7
2.3	54.0
2.4	56.3
2.5	58.6

- Mount a pivot angle indicator at each of the pivots with the .5 inch mark lined up on the baseline. The inner tip of the mark should be 4/4 inches out from the center of the base.

PIVOT BLOCKS AND VERTICAL GUIDE RODS

The pivot blocks are shaped from three-quarter inch thick hardwood stock as shown in the drawing.

- After shaping each block, drill the two holes shown.

- To provide a cursor mark to indicate the pivot angle, draw a vertical mark on center of the 1/8 inch wide point on the end of each block.

- Countersink the bottom of the 7/32 inch hole in each block using a 1/2 inch countersink bit.

- The vertical guide rods are made from three-quarter inch hardwood dowels.

- To mark the center of the end of each dowel, (a) draw a 3/4 inch circle using a compass; (b) cut the circle out; (c) place the circle on the end of the dowel and mark a dot on the end of the dowel through the hole made by the compass point.

- Using the mark made in the previous step as a guide drill a 1/16 inch hole 1-3/4 inches deep in the end of each dowel.

- Using a 5/32 inch drill bit, enlarge the hole in the end of the dowel to a depth of 1-1/2 inches.

ASSEMBLY

- Attach the dowels to each of the pivot blocks with a #12 x 2 1/2" flat head wood screw.

- Place the end of the dowel with the hole drilled in it over the 7/32 inch hole in the pivot block on the side opposite the countersink and insert the screw through the block into the dowel.

- Turn the screw in until it is snug; back it out again; fill the hole with glue or epoxy; retighten the screw fully tight. Be careful not to try and tighten the screw too tight or it might strip out of the wood.

- The three guides are attached to the base by the pivot bolts, washers and wing nuts.

FINISHING

The lower portions of the guides and pivot should be painted with a heat resistant paint.

Any other finishing is left up to the builder. However, painting and/or waxing the vertical guide rods will help prevent warping.

LIST OF MATERIALS

1/2" thick plywood stock
3/4" thick hardwood stock
9 x 9" floor tile (1)
3/4" x 36" hardwood dowels (3)
1/4" tee nuts (3)
1/4" brass bolts (3)
5/16" I.D. x 1" O.D. washers (3)
1/4" wing nuts (3)
#12 x 2-1/2" flat head wood screws (3)

LIST OF TOOLS

Pencil
Ruler
Compass
Protractor
Epoxy or contact cement
Screwdriver
Saw
Drill
1/4" drill bit
7/32" drill bit
5/32" drill bit
1/16" drill bit
1/2" countersink bit



Rejoice, NARAM is near! this nationals marks the tri-annual meeting of the association, highlighted by the election of a new Board of Trustees. Congratulations are due to the current Trustees for their achievements of the past three years. During this period, membership has increased by 50%, the number of sections has doubled, insurance coverage has tripled, and dues have increased by only \$2. Leader members have been given a share of the administrative load, a new headquarters was created, and reforms in many committees were effected. Also, several legislative battles were won including establishment of the NFPA code and the FDA exemptions mentioned elsewhere this issue. I hope the next board will maintain this enviable record.

I have been asked not to put anything "important" in The Editor's Nook because nobody reads. Apparently, some members missed a pink book rule change mentioned in the Nook many months ago. I think I missed it too.

Speaking of Pink Book rules, I'm a little bit disappointed with the reaction to our "If I Wrote the Pink Book" columns. Perhaps it hasn't been properly introduced. "If I Wrote the Pink Book" is intended to be a public forum for any NAR member who has constructive criticism to offer about the NAR Sporting Code. From all the gripes I've heard, there's enough to fill the entire *Model Rocketeer*.

By the way, the above paragraph was not written by me. It was written by your new acting editor, Jim Barrowman. Jim will act as my substitute during the next three months while I am travelling overseas. By the time you read this however, I will have almost returned so continue sending any correspondence for *The Model Rocketeer* to my Ithaca address. Mail is being forwarded to Jim during my absence—I hope. Incidentally, as you may have guessed, there is nearly a three month delay between the time I edit copy and the time you see it in print. This delay is due to my slow typing, proofreading, mailing to *Model Rocketry*, typesetting, page composition, final layout, mailing to printer, printing, binding, shipment to mailing agency, labeling, mailing, and last but certainly not least—the U.S. Post Office.

— Carl Kratzer

MASSACHUSETTS CAP SQUADRON CHARTERS

Announcement of the first NAR charter to be issued to a Civil Air Patrol unit was made in early May at NAR Headquarters. The Westover CAP Squadron Section of Westover AFB, Massachusetts chartered with 15 NAR members. Other CAP cadets in the squadron have also applied for NAR membership.

The section has established a three month model rocket training course, a technical library, a launching system and has planned to give demonstrations at other CAP units in the area.

Instrumental in forming the new section is 1st Lt. Lawrence L. Loos, a member of NAR since 1964. Lt. Loos is an information technician with the USAF at Westover. Senior advisor for the section is Capt. Frederick J. Miller, Jr., who has worked with the Massachusetts cadets since 1966.

The NAR eagerly awaits the chartering of other CAP units with the associations and welcomes the Westover section as the first.

IF I WROTE THE PINK BOOK

The following letter was received from NAR Secretary, John Belkewitch. While John requested that his letter be published in original form, editorial considerations make this impossible.

The section championship at a NARAM is a coveted honor and should remain as such. In the past, championship sections were made by size, not by ability or performance. With enough members, a section could crank out points in local meets faster than a hen lays eggs.

In fairness to all sections, I believe that in any form of NAR competition by a section in a section, area, or regional meet that these sections be allowed to amass points only in first, second, and third places (i.e. no "flight" points). All contestants would still be allowed full contest points but their points would not count toward the section total unless they placed in one of the top three slots in an event. Too much emphasis has been placed on points and not enough on craftsmanship, fair play, and sportsmanship. The present point system used to determine the championship section is not really a true measure of that section's ability. It hurts to see a section come into the national meet with the flag sewed up without making an effort.

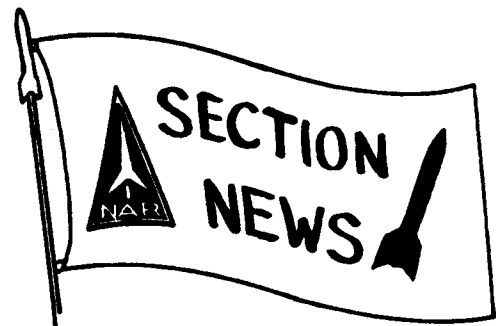

By Charles M. Gordon

The Tri-Cities Cosmotarians report in a recent newsletter of one way to raise money for club activities. To raise money to help transport section members to NARAM-12 the section held a car wash in May.

The Anchorage Association of Model Rocketry (Alaska) reports of a group of 17 Civil Air Patrol cadets and their sponsor, all from Elmendorf A.F.B., attended a meeting of the AAMR. The section President gave a brief history of the club and an explanation of model rocketry to the cadets. A display of model rockets including a 3 stage "F" were also shown.

The *EMANON*, newsletter of the YMCA Space Pioneers Section (New Canaan, Conn.) puts a new touch to model rocketry in this age of Aquarius in the form of "Starshine", a horoscope type listing for model rocketeers. And, you know what? For me they were right!

Mr. Mel Severe, Mountain Division Manager for NAR and Sr. Advisor of the Metro-Denver Section (Colorado) reports of a 200% increase in his area. From a total of 49 NAR members in Mountain Division in December, the total went to 154 as of March 15.

Keep at it, Mountain Division!

THE MODEL ROCKETEER

CONGRATULATIONS TO THIS YEAR'S SECTION NEWS-LETTER TROPHY WINNER. KEEP UP THE GOOD WORK.

On May 23, the Annual MAHAM-2 area meet between the NARHAMS section (Seabrook, Md.) and the MARS section (New Carrollton) was held. A total of 36 contestants battled it out to the end. Final points totals were MARS: 558 NARHAMS: 578. Congratulations NARHAMS.

Announcement is made of the appointment of Bob Mullane as NAR manager for section activities of the North East Division.

He replaces Jay Apt whose workload had required him to resign. The position will require reconfirmation after the elections at NARAM 12.

Many thanks Jay, and good luck Bob!

Congratulations to the Mars Area Rocketeers Section (Mars, Pa.) on the publication of Volume 1, Number 1 of their newsletter, *THE MARTIAN REVIEW*. This first issue reported of NASA films shown as a special activity, planned contests, and other news of the section and of NAR activities throughout the country.

The newsletter also reports of holding the Drag Race event at a recent contest, showing that it is not a dead event, yet!!

The South Seattle Rocket Society (Washington State) reports of plans to host the Pacific Northwest Area Meet (PANOWAM-1) in Seattle late in July. The original date for this meet between SSRS and the host section, Tri-Cities Cosmotarians (Gladstone, Oregon City, and Linn City, Oregon) which was set up in Oregon City was rained out when the contestants got to the range.

PANOWAM-2 is planned for sometime in September or October in Oregon City, hosted by the Cosmotarians.

The Randallstown Rocket Society (Maryland) reports that on April 5 Rick Lepski, a section member, made a video-taped TV appearance speaking on the merits of model rocketry and of the RRS. The name of the local station or network was not given.

The Fairchester Section (Stamford, Conn.) reports of plans to hold launches every two weeks from now until the end of November. Interested rocketeers should contact the section c/o 30 Fawn Drive, Stamford, Conn. for information on launching with the section.

In their newsletter, the *BANNER NEWS*, the Star Spangled Banner Section (Severna Park, Md.) reports that on August 3-15, Mondays thru Fridays members of the section will be teaching underprivileged children how to build model rockets.

It is also reported that 4 members of SSB went to the University of Maryland on May 5 to help Aerospace graduate students launch off rockets they had built. The students were required to build their own models and then to calculate the performance characteristics before they were flown. From all reports, the students did better this year than the last.

The SSB section also gave demonstration launches at two area elementary schools in mid-May.

CONGRATULATIONS to the NARCAS section (Camp Hill, Pa.) on the well run NARCAS Annual Record Trial (NART-1) held in May.

An NAR Section is being formed in the Charlestown Heights area of Las Vegas, Nevada. Interested model rocketeers should contact either Alma Wilkinson, 341 View Drive, or Phil Pappa, 413 Mallard, for information.

Brian Dolezal and Darrell Witkowski, members of the Natural Science Museum Model Rocket Research Society (Cleveland, Ohio) won first and second place respectively in the Earth-Space Category of the Northeastern Ohio Science Fair held March 19-21 in Cleveland, Ohio. Brian also won recognition from the Navy, Army, Air Force, and NASA on his project titled "Frictional Drag of Boost-Glide Vehicles." A part of the Navy award includes a week's tour aboard a naval ship this summer along with other science fair winners from the eastern part of the United States.

In May, the Xaverian High School held an Open House for the incoming class of Freshmen. The XHS Model Rocket Society Section (Brooklyn, N.Y.) placed on display over 170 model rockets, a rocket transmitter, arial cameras, and other assorted equipment. A great deal of literature was handed out by section members. A tremendous response was noted and a large turnout is expected in the fall.

The Santa Clara Rocket Association Section of the NAR (Palo Alto, California) has recently been reorganized. The reorganization came about because the group was getting too large and unwieldy. As an outcome of this reorganization, which created two sections out of the previous one, the group which remained the SCRA has decided to change its name to the Delta-V section. Although this may cause some confusion, in the long run it will simplify things now that there are two sections in Santa Clara County.

SPECIAL REMINDER

This notice is directed to all those who may have been sending Section News correspondence to the summer address in Pennsylvania.

The summer address given is only good until August 12 and not any later. *PLEASE* be sure that any correspondence sent to the summer address given last month will be received by August 15. If you are not sure just send it to the regular N.A.R.S.N. address.

Remember, if you don't want your mail lost, be sure to follow the schedule. If I don't get it - I can't use it.

NAR SECTION NEWS appears each month as a regular feature in *THE MODEL ROCKETEER*. Those sections wishing to have news and/or information of their activities printed in this column should submit such material to:

NAR SECTION NEWS EDITOR
Charles M. Gordon
192 Charolette Drive, Apt. #2
Laurel, Maryland 20810

NAR SECTION ROSTER

- 101—ANCHORAGE ASSOCIATION OF ROCKETRY, Jim Eshenower, 2712 Kobuk Circle, Anchorage, Alaska 99504; 102—ANNAPOLIS ASSOCIATION OF ROCKETRY, Robert Atwood, Route 3, Box 98B, Annapolis, Maryland 21403; 103—APOLLO—NASA, Forrest McDowell, Jr. 10058 Larston Street, Houston, Texas 77055; 106—BELAIR ASSOCIATION OF MODEL ROCKETRY, Robert Seufert, 12400 Starlight Lane, Bowie, Maryland 20715; 107—BERWICK ACADEMY ROCKET SOCIETY, Charles Andres, Academy Street, South Berwick, Maine 03908; 108—BETHLEHEM SECTION, Frank Osborn, 1408 Cottage Avenue, Bethlehem, Pennsylvania 18018; 109—BIRCH LANE ROCKET SECTION, Thomas Hills, 2429 Temple Drive, Davis, California 95616; 110—BLACK HAWK SECTION, Dennis Darland, 410 18½ Avenue, Rock Island, Illinois 61201; 113—COLUMBUS SOCIETY FOR THE ADVANCEMENT OF ROCKETRY, Gerald Gregorek, 4451 Danforth Road, Columbus, Ohio 43229; 114—TRI-CITY COSMOTRIANS, William D. Boggs, 730 East Dartmouth Street, Gladstone, Oregon 97027; 115—FAIRCHESTER, Bruce Shay, Vineyard Lane, Westport, Connecticut 06880; 116—GEMINI MODEL ROCKET SOCIETY, Scott Brown 204 Delaware Street, New Castle, Delaware 19720; 117—GLEN ELLYN ROCKET SOCIETY, F. Scott Godron, 476 Main Street, Glen Ellyn, Illinois 60137; 120—LAUREL AREA ROCKET SOCIETY, Raymond Werre, 313 Old Line Avenue, Laurel, Maryland 20810; 125—MAMARONECK LARCHMONT ROCKETRY ASSOCIATION, Bernie Ferrer, 350 Prospect Avenue, Mamaroneck, New York 10543; 126—MANSFIELD AERONAUTICS AND SPACE ASSOCIATION, Doug Ball, 786 Forest Drive, Mansfield, Ohio 44905; 127—MENTOR ROCKET CLUB, H. David Rice, P.O. Box 265, Mentor, Ohio 44060; 128—METRO ATLANTA SOCIETY FOR EDUCATIONAL ROCKETRY (MASER), 3643 Mill Creek Road, Atlanta, Georgia 30319; 129—METRO DENVER ROCKET ASSOCIATION, Juanita Severe, 8361 Chase Way, Arvada, Colorado 80002 130—METROPOLITAN AREA ROCKET SOCIETY (M.A.R.S.), Peggy Sipes, 5012 60th Avenue, Hyattsville, Maryland 20781; 131—MAJOR GENERAL HOLGERN TOFTOY MEMORIAL SECTION, Guy M. Norlin, P.O. Box 704, Aberdeen, Maryland 21085; 134—M.I.T. MODEL ROCKET SOCIETY, William Gengen, Box 110, M.I.T. Post Office, Cambridge, Massachusetts 02139; 135—NATURAL SCIENCE MUSEUM MODEL ROCKET RESEARCH SOCIETY, Walter E. Mueller, Natural Science Museum, 10600 East Boulevard, Cleveland, Ohio 44106; 136—MONROE ASTRONAUTICAL ROCKET SOCIETY, Greg Howick, 2424 Turk Hill Road, Victor, New York 14564; 138—NAR CAPITOL AREA SECTION (NARCAS), Frances S. Guernsey, 2915 Maple Road, Camp Hill, Pennsylvania 17011; 139—NARHAMS, James Barrowman, 6809 97th Place, Lanham, Maryland 20801; 141—NORTH JERSEY ROCKETRY ASSOCIATION, 288 Crocker Place, Haworth, New Jersey 07641; 142—NORTH SHORE SECTION, Daniel Weiss, 239 Normandy Road, Massapequa, New York 11758; 143—PASCACK VALLEY, Robert Mullane, 34 Sixth Street, Harrison, New Jersey 07029; 144—QUEEN CITY MODEL ROCKET RESEARCH SOCIETY, James Backlas, 317 Loepere Street, Buffalo, New York 14211; 146—RANDALLSTOWN ROCKET SOCIETY, Walter G. Moon, 3702 Woodspring Court, Randallstown, Maryland 21133; 149—ROCK CREEK SECTION, Marjorie R. Townsend, 3529 Tilden Street, Northwest, Washington, D.C. 20008; 150—ROCKVILLE ROCKETEERS, Jim Philmon, 5111 Crossfield Court, Rockville, Maryland 20852; 152—SATURN MODEL ROCKETRY SECTION, David William Shindo, 104 Chip Chip Way, El Paso, Texas 79915; 153—SMARS, Mark L. Davis II, 208 South Walnut Street, Milford, Delaware 19963; 154—SOUTHLAND ASSOCIATION OF ROCKETRY, Michael Poss, 7855 Naylor Avenue, Los Angeles, California 90045; 156—STAR SPANGLED BANNER, Howard Galloway, 428 Ben Oaks Drive West, Severna Park, Maryland 21146; 157—STEEL CITY SECTION, Marvin Lieberman, 3 Coleridge Place, Pittsburgh, Pennsylvania 15201; 159—THE ORBITS, Tom Daniels, c/o Mrs. Leslie Derkowitz, 1562 Katie Avenue, Las Vegas, Nevada 89109; 162—WEST COVINA MODEL ROCKET SOCIETY, Dane M. Boles, 3723 Gilman Road, Apartment 22, El Monte, California 91732; 163—WHEATON ROCKET ASSOCIATION, Jerome H. Trager, c/o Hobbies Unlimited, Incorporated, Wheaton Plaza, Wheaton, Maryland 20902; 165—XAVERIAN HIGH SCHOOL MODEL ROCKETRY SOCIETY, Julius Malecki, 320 Marine Avenue, Brooklyn, New York 11209; 166—NEW CANAAN YMCA SPACE PIONEERS, G. Harry Stine 127 Bickford Lane, New Canaan, Connecticut 06840; 167—ZENITH, Ellsworth B. Beetch, 211 Clover Lane, Mankato, Minnesota 56001; 168—MIDWESTERN ROCKET RESEARCH ASSOCIATION, Jeff Mason, 7926 Kessler, Overland Park, Kansas 66204; 169—TECHNOLOGICAL INSTITUTE FOR ROCKET OBSERVATION AND STUDY (T.I.R.O.S.), Dennis A. Okesson, 531 Lake Street, Crystal Lake, Illinois 60014. 170—BERKELEY HEIGHTS ROCKET SOCIETY, Michael Quelly, 40 River Bend Road, Berkeley Heights, New Jersey 07922; 171—ROBERT GODDARD JUNIOR HIGH SCHOOL MODEL ROCKET CLUB, Jimmy Johnson, P.O. Box 622, Seabrook, Maryland 20801; 172—THREE RIVERS SECTION OF NAR, Tom P. Wuellette, Jr. 353 Hawthorne Road, Pittsburgh, Pennsylvania 15214; 173—SANTA CLARA ROCKET ASSOCIATION, David Cohan, 1425 Edgewood Drive, Palo Alto, California 94301; 174—SOUTHERN CALIFORNIA ROCKET SOCIETY, Mrs. John Yanos, 2709 West Adrin Way, Santa Ana, California 92704; 175—THE GOOD, THE BAD, AND THE UGLY ROCKET CLUB, Wiley A. Styles, Palatka Middle School, 1100 Husson Avenue, Palatka, Florida 32077; 176—SOUTH SEATTLE ROCKET SOCIETY, Jess S. Medina, 15824 43rd Avenue South, Seattle, Washington 98188; 177—MOON SNOOPERS, c/o St. Thomas More School 9130 South California, Chicago, Illinois 60652; 178—HAWKEYE SECTION OF NAR, Matt Kabel, 2018 Marquette Street, Davenport, Iowa 52804; 179—OUTA-SIGHT, Patrick Hickert, Route 7, Box 60, Wayzata, Minnesota 55391; 180—METRO CLEVELAND ROCKET SOCIETY, Robert H. Allen, 1437 Seneca Boulevard, Broadview Heights, Ohio 44141; 181—NORTHGLENN MODEL ROCKETEERS, Daniel L. Eastman, 10909 East 109th Place, Northglenn, Colorado 80233; 182—LONAR, John Fensterer, 4854 Juneway Drive North, Liverpool, New York 13088; 183—NORTHSIDE ROCKET CLUB, Joe Guthridge, 2765 Northside Drive, Atlanta, Georgia 30305; 184—COSMOS ORBITS SECTION OF THE NAR, David Wayne Valkema, 13737 Somerset Road, Poway, California 92064; 185—BLUE RIDGE ROCKET ASSOCIATION, Brent R. Heizer, 408 Ridge Circle, Waynesboro, Virginia 22980; 186—MARS AREA ROCKETEERS, David Marshall, RD 3, Box 212, Valencia, Pennsylvania 16059; 187—LOS ALAMITOS—ROSSMOOR SECTION, Craig Barnes, 11912 Foster Road, Los Alamitos, California 90720; 188—LOYOLA ROCKET CLUB, Marin Popoff, 3715 Tracy Street, Los Angeles, California 90027; 189—MARINER ROCKET SOCIETY, David Lien, 424 South Pleasant, Whitewater, Wisconsin 53190; 190—MODEL ROCKETEERS OF LODI, N.J., James Sedita, 59 Mitchell Street, Lodi, New Jersey 97644; 191—MODEL ROCKETRY CLUB WHEELING HIGH SCHOOL SECTION, James Levins, 900 South Elmhurst Road, Wheeling, Kentucky 60090; 192—AEROSPACE RESEARCH ASSOCIATION OF NORTHWESTERN PENNSYLVANIA, P.O. Box 50, Meadville, Pennsylvania 16335; 193—POLARIS, Scott Newton, 2270 Tulsa Avenue, Claremont, California 91711; 194—MIDDLETOWN, ODESSA, TOWNSEND ASSOCIATION OF ROCKETRY (MOTAR), Nancy E. Hammond, RD 1, Box 35, Townsend, Delaware 19734; 195—WESTOVER CAP SQUADRON SECTION, Douglas Squires, P.O. Box 231, Chicopee, Maine 01021; 196—EAST COAST EXPERIMENTERS, Lois Marie Fusco, 345 Cedar Avenue, Holmes, Pennsylvania 19043; 197—LUCKY 13, Mark Taras, Route 1, Box 1497, Montgomery, Texas 77356; 198—HOBBY LOBBY BOOSTERS, Robert William Miller, P.O. Box 3763, Lafayette, Louisiana 70501; 199—NORTHWESTERN INDIANA ROCKET ASSOCIATION, Robert Furr II, 201 South Part, Fowler, Indiana 47944; 200—CENTRAL MODEL ROCKET CLUB, Richard H. Jones, Jr., 29 International Avenue, Piscataway, New Jersey 08854; 201—PALATINE MODEL ROCKET CLUB, George Kraft, 712 E. Greenwood Court, Palatine, Illinois 60067; 202—VANGUARD ASSOCIATION OF ROCKETRY, Gloria Gomez, 75 East Wayne Avenue, Silver Spring, Maryland 20901; 203—VIRGINIA ROCKET CENTER SECTION, Charles Butler, 4010A Glenside Drive, Richmond, Virginia 23228; 204—SOUTHERN MARYLAND AREA ROCKET TEAM (SMART), Ralph R. Swick, RR1, Box 580, Accokeek, Maryland 20607.

DEALER DIRECTORY

Hobby shops desiring a listing in the **Model Rocketry Dealer Directory** should direct their inquiries to Dealer Directory, **Model Rocketry** magazine, Box 214, Boston, MA 02123. Space is available only on a six month contract for \$18.00, or a twelve month contract for \$35.00, payable in advance.

CALIFORNIA — Mt. View

Model Rocket Supplies
San Antonio Hobby
417 San Antonio Rd.
Sears Shopping Center

CALIFORNIA — Whittier

Complete Selection of Model Rockets
Estes — Cox — Centuri — MPC
JACK'S HOBBYCRAFTS
14710 E. Whittier Blvd. 90605
Mon.-Thurs. 10-6, Fri., 10-9, Sat., 9:30-5:30

CONNECTICUT — Bridgeport

Model Rocketry & Radio Control
is our only business
FRED'S VARIETY
184 Success Avenue Bridgeport

CONNECTICUT — Bridgeport

Complete Rocketry Supplies
is Our Specialty
ESTES — CENTURI — ETC.
BOB'S HOBBIES
1542 Wood Avenue
Bridgeport 06605

DELEWARE — Wilmington

All Major Rocket Lines
SIMPSON'S HOBBIES, INC.
709 Foulk Road
Wilmington, Delaware 19803
Mail Orders Tel.: 654-5022

FLORIDA — Gibsonton

Save!!! All Brands
Write for Lists and Discounts
PAT'S PLACE
P.O. Box 118
7:30 — 6 Mon. to Sat. 813-677-6310

ILLINOIS — Chicago

M&G HOBBY SHOP
3443 N. Pulaski Rd
Chicago, Ill. 60641 Phone: 539-5310

MASSACHUSETTS — Melrose

MIDDLESEX COIN, STAMP &
HOBBY SHOP
473 Main Street
02176 662-8319

(Club Notes, continued)

designs were flown by club members. Richard Malecki flew his modified Estes Bertha with an interchangeable engine mount. It made a flawless flight powered by an "E" engine. Bob Thoelen lost his modified Arcas coupled to a B14-0 booster when it parachuted into a swamp. Ralph Schiano's Monstrosity II, a Lindberg Mars Probe Communications Satellite extended to almost two feet long with BT-70 tube, was prevented from flying due to a flawed fin.

Two weeks later, on May 10th, the XHSMRS #4 competition was held. This time the day was clear and bright, but there were high shifting winds. Bob Thoelen took first place in the combined Leader/Senior Division while John McDonald placed first in Junior.

In Wooster, Ohio, Principal Thomas Goetz supervised the launching of model rockets by students at the Chester school. All interested students were excused from their classes at 1 P.M. to allow them to assemble in the school yard for the launching of 20 different model rockets. The rockets were constructed by students Mark Stroud, Daniel Snoddy, Jeff Smith, Ronnie McFadden, Drew Duncan, Stephen Boyer, and Dale Imhoff. After the launching, the boys were available to answer questions from students and teachers.

On Saturday May 9th a successful model rocket and model airplane contest, sponsored by the Model Club and Recreation Department, was held in Glastonbury, Connecticut. Rockets were flown in two classes, beginner and advanced, with Jeff Adamson winning in the beginner category, while Dave Schlutz took 1st place in the advanced competition. In addition Control Line and Hand-Launched glider model airplane competitions were flown.

Cumberland Composite Squadron, Civil Air Patrol of Millville, New Jersey, held its first rocket launch on the second Saturday in June. A total of 22 rockets lifted into the sky, among them Estes Scouts, Avenger, and V-2 models. The Cadets are headed by Senior Member John Komorowski who is also a Senior member of the NAR (#4619). The group is currently working on the details of a launch panel, tracking stations, and range communication equipment. The Squadron hopes to eventually affiliate with the NAR and to stage CAP-NAR competitions.

The Tower Grove Aerospace Explorers in St. Louis, Mo. are sponsoring a competition which is open to all model rocketeers in the area. The contest will be held on August 22, and there will be three events — Class I single-stage altitude, Class II parachute duration, and Sparrow B/G duration. All modelers wishing to compete should contact Randy Picolet at 6039 Southwest Ave., St. Louis, Mo. 63139, before August 15. However, a communications system and P.A. system are needed, as are qualified judges. Anyone who could help in any way, please contact the above address as soon as possible. This is the club's first competition and

they would appreciate any help that other rocketeers can provide.

The newly formed "Burnaby Model Rocket Club" in British Columbia, Canada is interested in contacting other clubs in Canada and U.S.A. particularly Washington State. The club now numbers some 60 enthusiastic members, and wishes to have meets with other clubs in 1970. Please contact Mark Sanders, 6714 Hershaw Ave., Burnaby, B.C. Canada.

Results are in from the South Seattle Model Rocket Society SEAMEE II meet held on May 24th. In the Junior Division Tony Medina took first in Eggloft with a flight to 1,180 feet, while Jim Pommert's 50.2 second Hornet B/G flight took first in that event. Mike Medina edged out Randy Sprague for first place in Single Payload with 1,140 feet, and Ken Lamond took first in Class II Altitude with 1,970 feet. In the Senior Division numerous DQ's and failure of their tracks to close resulted in no qualified flights in the Eggloft and Single Payload events. In Class II Altitude Jim Worthen took first place with 1,820 feet, and Jim Jakeman took first in Hornet B/G with 19.2 seconds.

A model rocket club is being formed in Snellville, Georgia. Rocketeers interested in joining the Snellville Astronomical and Research Association should contact Michael Johnson, Route 1, Dogwood Drive, Snellville, Georgia 30278, or call 404-963-6934 after 6 PM.

The results of the CAP sponsored Green Bay, Wisconsin rocketry meet held in April are as follows: first went to Christopher Brien; second to Jim Smits; third to Randy Peterson; and fourth (honorable mention) went to Tom Case. The events flown were one-stage altitude, cluster ignition, payload (live) competition, and odd-ball competition. There were about 20 participants and over 150 spectators present. Coverage was provided by both newspaper (Green Bay Press-Gazette) and TV (Channel 5) reporters. The highlight of the meet came with the launching of live payloads. Larry Bummefeld launched a mouse within an Astron Scrambler and Christopher Brien launched Centaur (a zebrafish) inside of a modified Bertha.

The Rocket Research Club of Bedford County, Va. is just getting started and the two officers Ricky Howell and David Colwell are looking for members in the Bedford County area. If you are interested please call or write either David Colwell or Ricky Howell... David Colwell (phone) 297-4946 (write) Rt 2 Box 232, Moneta, Va. 24121. Ricky Howell (phone) 297-2457 (write) Rt 4 Bedford, Va. 24523.

A model rocketry section has been formed within the Driscoll Aerospace and Astronomical Research Society, a science club of Driscoll High School, Addison, Illinois. There are twelve members of D.A.A.R.S. who are active in the model rocket group, and are doing research in biology and aerodynamics. The club had a "Launch

NEW JERSEY — Edison
 Complete Rocket Supplies
 MINIWHEELS RACEWAY &
 HOBBY CENTER
 1603 Lincoln Highway
 ESTES, CENTURI, MPC, BOMAR, ETC.

NEW JERSEY — Princeton
 Complete Rocket Supplies
 Centuri — Estes — MRI — Space Age Ind.
 NASSAU HOBBY
 142 Nassau St. Princeton, New Jersey

NEW JERSEY — Wayne
 TOTOWA HOBBY SHOP
 131 Boonton Road
 Rocketry isn't our only Hobby!
 is only one hobby section
 Open Sundays 696-5170

NEW YORK — East Meadow
 "World's Leading Hobby Store"
 Complete Department Store of all hobbies
 (especially rocketry)
 POLK'S HOBBY DEPT. STORE
 2072 Front Street
 East Meadow, Long Island (516) 489-1166

NEW YORK — Elmira
 ESTES — CENTURI — FLIGHT SYSTEMS
 SCIENCENTER
 147 West Water St.
 Elmira, New York 14901

NEW YORK — New York City
 "World's Leading Hobby Shop"
 Complete department store of all hobbies
 (especially rocketry)
 POLK'S HOBBY DEPT. STORE
 314 5th Avenue
 New York City (212) 279-9034

NEW YORK — Uniondale
 Biggest and the Best with the Most
 Estes & Centuri
 CARD & CRAFT
 1004 Front St.
 Mon., Thurs. & Sat. 9-6—Fri. 9-9—Sun. 10-3

NORTH CAROLINA — Chapel Hill
 BILLY ARTHUR, INC.
 North Carolina's Leading
 Rocket and Hobby Center
 Eastgate Shopping Center
 9 to 9 Monday thru Friday 9 to 6 Sat.

OHIO — Mansfield
 BOB & PETE'S HOBBY SHOP
 707 Park Ave. East
 Estes-Centuri-Flight Systems-MPC
 Where the Champions Buy
 Mon to Fri 3 to 9 Sat 9 to 9

OHIO — Upper Sandusky
 Centuri and Estes Rockets
 THE ROCKET SHOP
 640 Skyline Drive
 6 to 9 P.M. 294-1322

WASHINGTON — Seattle
 Rocketry for the Northwest
 Nationally Known Brands
 CAMPUS HOBBY CENTER
 4738 University Way N.E.
 Open Thurs. Eves. Phone: LA5-2222

CANADA — Toronto, Ontario
 Canada's only exclusive rocket shop
 Home of the Canadian Rocket Society
 Complete facilities and hobby consultants
 THE SCIENCE SHOP
 137 Yonge St. Arcade
 H. Diamond Lic. Supervisor #13

Day" on May 22nd, during which several experiments and demonstration launches were carried out. On Saturday June 6th the club had a model rocket competition with the Lake Park Rocket Society, with Eggloft, Altitude, Spot Landing, and Parachute Duration events being flown.

The Cedar Rapids, Iowa, Astro-Research Team is looking for new members in the Cedar Rapids metropolitan area. We have had several successful Altitude, B/G, and Egg-loft competitions in preparation for NAR sanctioned competition. We have a great deal to offer the model rocketeer, including five-color flight patches, the use of computerized launch equipment, newsletters, and many other privileges. Contact Thomas Cook, Riverside Recreation Center, 398-5170 for more membership information.

A model rocket club is being organized in the Fonda, Iowa area. Interested rocketeers are asked to write Dale Meyer, Fonda, Iowa 50540 or call (712) 288-5353 for more information.

The results of the CAP sponsored Green Bay Wisconsin rocketry meet held in April are as follows: first went to Christopher Brien; second to Jim Smits; third to Randy Peterson; and fourth (honorable mention) went to Tom Case. The events flown were one-stage altitude, cluster ignition, payload (live) competition, and oddball competition. There were about 20 participants and over 150 spectators present. Coverage was provided by both newspaper (Green Bay Press-Gazette) and TV (Channel 5) reporters. The highlight of the meet came with the launching of live payloads. Larry Bummeled launched a mouse within an Astron Scrambler and Christopher Brien launched

Centaur (a zebrafish) inside of a modified Bertha.

There is a NAR section being formed in the Hardin County, Kentucky area. Interested rocketeers should contact Terry Dean, 306 Cheryl Ave., Vine Grove, Kentucky, 40175.

●●●●●●

Send your club or section newsletters, contest announcements and results, and other news for this column to:

Club News Editor
 Model Rocketry Magazine
 P.O. Box 214
 Astor St. Station
 Boston, Mass. 02123

RD-107 "VOSTOK"

35mm Color Transparencies Suitable for Scale Substantiation of the USSR "VOSTOK" Manned Launch Vehicle. All photographs are taken from official Soviet motion pictures and stills.

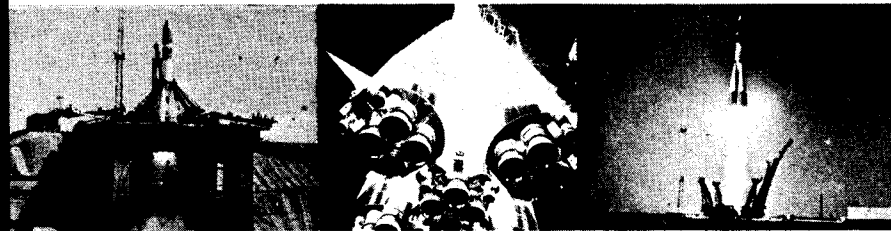

- 1 Ignition — On the pad at the USSR Baikonour Cosmodrome. Clearly shows the olive colored shroud, and white frost on rocket.
- 2 Thrust Buildup — The tie-down clamps hold the Vostok to the pad as thrust builds up. Launcher detail clearly visible.
- 3 Liftoff — The rocket is surrounded by flames and smoke at liftoff.
- 4 Climbing — The "VOSTOK" is shown rising 100 feet above the launch pad. The rear section of the strap-on engines seem to be red from the heat.
- 5 Pad View — Flame trail from climbing rocket still visible. Detail of the hold-down clamps is shown.
- 6 End View — The "VOSTOK" full size model on display in Moscow.

Only \$1.00 each, all six for \$5.00. Order Today. Supply Limited:

Rocket Equipment Co., 10 Mulberry Ave., Garden City, NY 11530

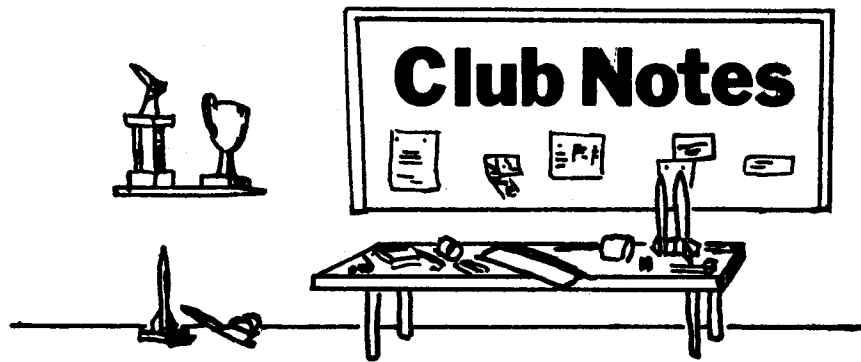

The latest issue of *The Modroc Flyer*, newsletter of the South Seattle Rocket Society in Seattle, Washington, reports the results of that club's first NAR sanctioned Section Meet. SE-ME 1, flown from the Boeing Space Center site in Kent, Washington, was held on April 11th. Previously SE-ME 1 was twice postponed because of bad weather. It was a good day for the Seniors, with Senior results topping the Juniors in all events except Spot Landing. In Class 1 Altitude Lewis Walton took Senior first place with 1055 feet, while Tom Medina took first in the Junior Division with 1003 feet. Gerald Doody took the Senior Class 1 PD honors with 105.6 seconds, while Jim Jakeman placed first in the Junior Division with 83 seconds. There was only one qualified Senior Swift B/G flight, Lewis Walton's 32.2 second flight. In Junior Swift B/G Pete Berg's 13.1 second flight took first. In Open Spot Landing Ron Pera's 33ft 3 inch distance took first place in the Senior competition, while Mark Medina's 17 ft 3 inch distance was good enough for first in Junior.

On April 18th the Delta-V NAR Section in Palo Alto, California held its second Section Meet of the year. Though no times or altitudes were reported in their newsletter,

Hi Lights, they report that David Sandlin took first in Sparrow B/G, the Chris Rook/Dan Compton team took first in PD, and Dan Livingston took first in Parachute Spot Landing.

The Kiwanis Club of Lodi, New Jersey recently made a donation of operating funds to the Model Rocketeers of Lodi. John Mandaro, president of the Lodi Kiwanis Club, presented a check to James Sedita of the rocket club. The Kiwanis club made the donation in order to encourage scientific study among the youngsters of the town.

On Thursday April 30th the Lloyd Road School held the first official model rocket launching in Matawan Township, New Jersey. The event, organized by Louis Di Girolamo, an eighth grade science teacher, was supervised by the Matawan Township Fire Department. David Day and Gary Gough served as firing officers, while some thirty students served on the recovery team.

Brian Markee would like to start a rocket club in the Oyster Bay, New York area. Interested rocketeers can contact him at WA2-3956.



Because of size, the Santa Clara Rocketry Assoc. is splitting into 2 separate sections. A recent list showed 200 modelers in the area. Any sections, or rocketeers interested in competing with us are encouraged to contact: Dan Compton, 15040 Oriole Rd., Caratoga, Calif. 95070. Several contests are on the drawing board for this summer, and at S.C.R.A.M. 4, a recent contest, a 17 minute, 27 second class 1 parachute record was set, as the rocket was carried away by a thermal. It was recovered however, and a record is being applied for. At one late launch, a cluster D13 bird left the pad blazing only to be recovered with 1 burnt engine. Club members are working on telemetry high altitude ignition, and different types of staging. Anyone in the area is invited to any of the club launchings, if a member of the N.A.R.

Members of the sixth grade science class at Sherwood Heights School near Pendleton, Oregon have been introduced to model rocketry. Under the supervision of science teachers Bill Arkell and C. H. Waltz, a number of boys from the school have been launching regularly.

Members of the Madison Rocket Club in Madison, Alabama staged a demonstration launching at the Old Huntsville Airport on April 26th, 1970. Stanley Hudson, the club president, served as range safety officer at the launching during which over 40 model rockets were fired. The club staged the launching as a publicity effort, and donations were accepted from the spectators to raise money for several aerospace field trips scheduled for the summer.

Sixth grade students at the Union Elementary School in Huntington, Indiana completed their fifth Annual Spring Rocket Launch on April 29th with the firing of 35 rockets on school grounds. A total of 28 students from the classes of Pauline Fullhart and Royal Saufley are participating in the science project which includes the construction and launching of model rockets. Each student participating in the program buys his own rocket kit or parts and completes the construction himself. The rockets are then inspected for defects, and safety checked before the launch day. Among the rockets launched was a four foot Saturn V, built as a combined effort by the two science classes.

On Monday April 20th the Five-Boro Jaycee Boys' Corps held a successful model rocket demonstration at Point Field in Whitaker, Pennsylvania. Whitaker Fire Chief Francis Fry and Mayor Edward Gretz were among the officials to witness the demonstration which was under the supervision of project chairman Joe Cocco. Jaycee Syl Lacey, at the controls of the launching system, counted down the rockets as 150 spectators watched the miniature Saturn 1B streak into the sky.

The latest issue of *SARC Spark*, newsletter of the Allentown, Pennsylvania rocket club, reports the results of their Mini-MARC contest held on April 26th. Since it was a windy day, the PeeWee Payload and Parachute Duration events were canceled. Despite the weather, 25 rockets were flown. In Class 1 Altitude, the winning altitude was 336 feet, while it took a flight to 460 feet to win Class 2 Altitude. In spot landing all five entries were Estes Birdies powered by 1/2A engines. Though distances were not measured very carefully, the winner was slightly under fifty feet from the target. In Hornet B/G a 1/2A powered FlatCat beat out a Nighthawk, but both were seriously underpowered.

On April 29th the Xaverian High School Model Rocket Society held a general launch from the south beach field in Staten Island, New York. Despite the cold and rainy weather, a number of new experimental

(Continued on page 46)

ONE GOOD THING...



LEADS TO ANOTHER

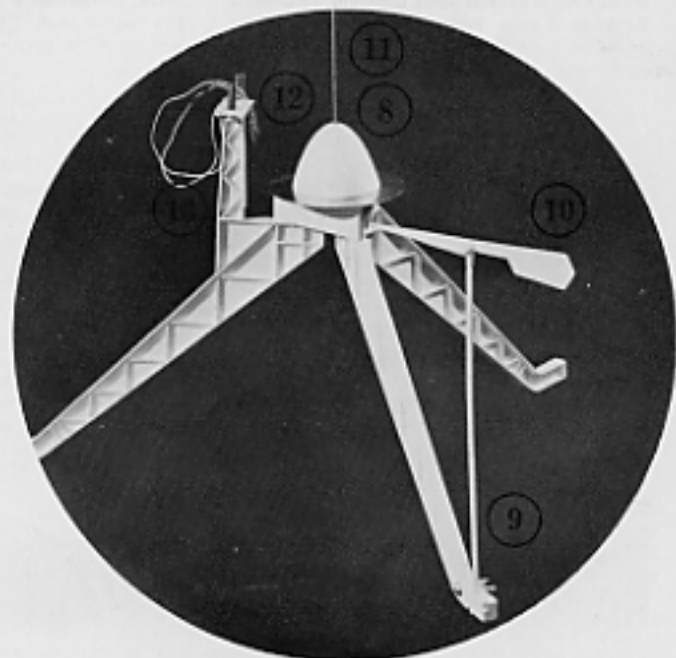

The new MPC Lunar-Lectric Launch Controller features ① handle for sure-grip comfort and safety, ② car lighter adapter, ③ 10 ft. firing line, ④ 8 ft. power cord, ⑤ recessed push button, ⑥ continuity light and ⑦ safety key.

The new MPC Lunar-Lectric Launch Pad is feature-loaded with a ① ceramic exhaust deflector to eliminate shortouts, ② tilt-leg adjustment to allow changes in flight direction, ⑩ wind direction indicator to help calculate flight direction and an ⑪ adjustable launch lug support to allow use of all shapes of rockets, ⑫ self supporting micro clips and ⑬ functional gantry.

It all leads up to the most professional launch system.





ESTES

launches a
SPACE SPECTACULAR
with
FREE ROCKET KITS
for you!!

You can get Free Rocket Kits at your participating hobby dealer during the Estes Space Spectacular.

Your hobby dealer – in cooperation with Estes, the leader in model rocketry – has a special Customer Bonus Plan for you. With every \$5 purchase – you get another kit, FREE! The more Estes rocket kits you buy, the more free kits you get!!

Get the best value from your hobby dollar from Estes, the company that makes four out of every five model rockets sold.

Estes has sold more than five million rockets – from the simplest kits that get you started to the ultra-sophisticated rockets that qualify you as an expert in the model Space Age.

Check it out with your dealer. Tell him you want to get in on the

ESTES SPACE SPECTACULAR!!

ESTES INDUSTRIES, INC.

Dept. 31-G / Penrose, Colorado 81240

If no dealer near you, write us direct.

Payment enclosed. Please send me:

- KS-2** : Alpha Kit, 2 engines, design manual, instructions \$2.00
- KS-7** : Same as above plus electric launcher w/batteries \$7.00
- New color-illustrated 144-page catalog (free with order) 25c

NAME _____

ADDRESS _____

CITY _____

STATE _____

ZIP _____