

MODEL ROCKETRY

OCTOBER 1968
35¢

**DYNAMIC
STABILITY**

SCALE BOMARC

**BUILD THE APEX
HIGH ALTITUDE**

EGGLOFTER II

DRAGSTAB

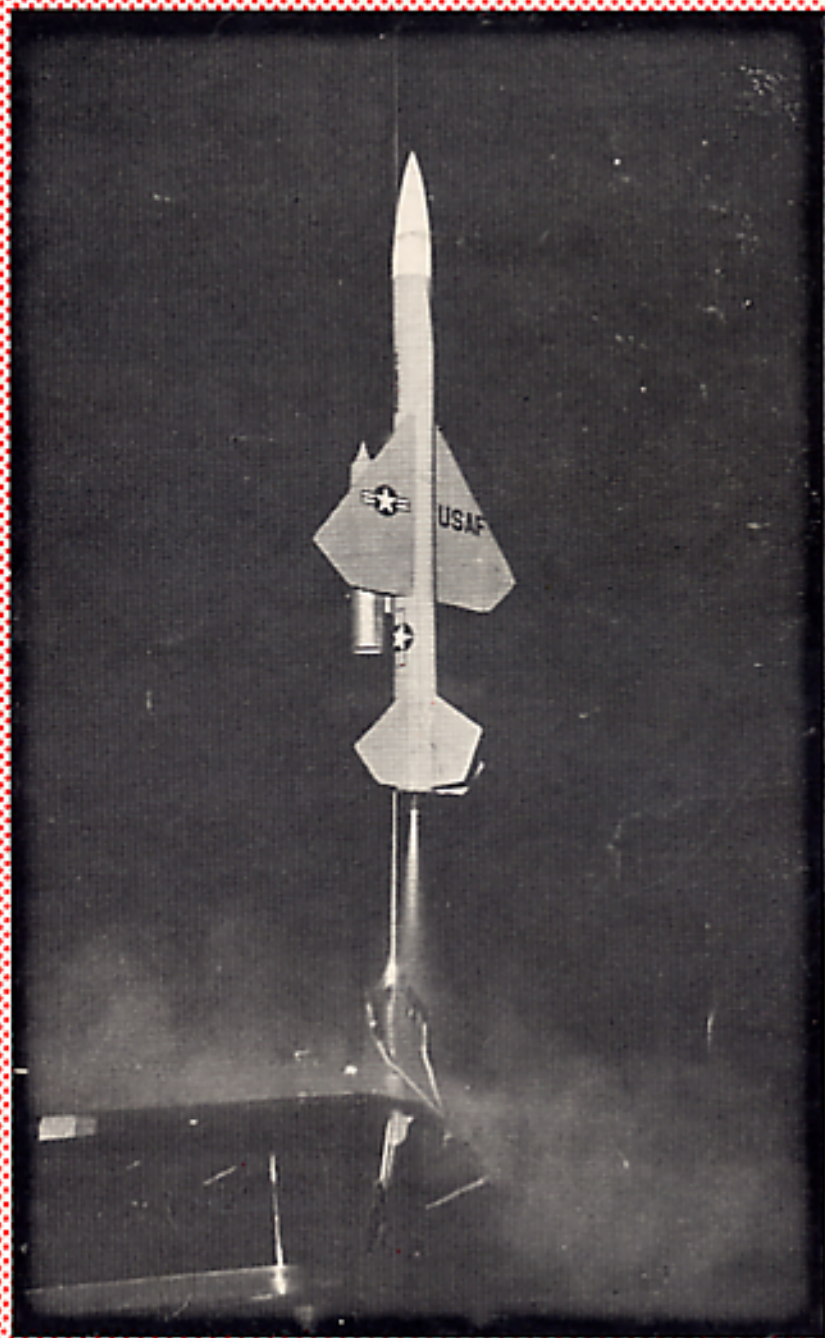

MODEL ROCKETRY

Vol. 1, # 1
Oct. 1968

EDITOR GEORGE FLYNN
MANAGING EDITOR GORDON MANDELL
BUSINESS MGR GEORGE CAPORASO
DISTRIBUTION MGR THOMAS MILKIE

From the Editor

We would like to applaud the efforts of those who were instrumental in drawing up the recently adopted National Fire Prevention Association (NFPA) code relating to model rocketry. In the new code, for the first time, the NFPA distinguishes between model rockets and fireworks. This code sanctions the proper use of model rockets.

However, model rocketry is still illegal in many states. Model rockets are still considered fireworks in these states.

The excellent safety record of model rocketeers is testimony to the fact that model rocketry need not and should not be prohibited. With the new NFPA code, many state legislators will now be more receptive to appeals for legislation to permit model rocketry. However, they will not act spontaneously. Model rocket clubs and interested individuals in those states where model rocketry is still outlawed must now do their part.

You must approach local legislators and interested civic groups and demonstrate to them the educational value of model rocketry. You must propose to your legislator that the section of the NFPA code relating to model rocketry be incorporated into their state law. Finally, you must follow through; keep track of the proposed legislation, and make sure that it is not permanently put aside in favor of more "important" legislative business. Only through the united effort of the model rocketeers and interested citizens in each state will get a system of state laws which recognizes the value and safety of model rocketry.

	Page
Dragstab—A Rocket Without Fins	2
Wallops Station	6
Apex I—High Altitude	8
Model Rocket Altitude Calculations	11
How to Apply Decals	13
Scale: Bomarc B	14
New Product Notes	20
Fundamentals of Dynamic Stability	21
Questions & Answers	29
Egglofter II	30
Technical Notes	32

© 1968

Model Rocketry Magazine is published monthly by Model Rocketry, Box 214, Boston, Mass. 02123, at Central Sq. Cambridge, Mass. 02139.

Subscription rates: In U. S. and Canada, 1 year \$3.50; Six months \$2.00; single copy 35¢. Foreign, 1 year \$6.00; Six months \$3.50; single copy 60¢.

Material submitted for publication should be accompanied by self-addressed envelope if return is desired. We can assume no responsibility for material lost or damaged, but care will be exercised in handling.

Advertisers should contact Advertising Manager, Model Rocketry, Box 214, Boston, Mass. 02123.

Application to mail at second-class postage rates is pending at Central Sq. P.O., Cambridge, Mass. 02139.

DRAGSTAB:

A ROCKET WITHOUT FINS

by TOM MILKIE

Most every rocket today is built in the same old way – with fins hanging on the back. Making a model rocket go in the direction you want, instead of careering about the sky and smashing into the ground, has finally been accomplished without fins, in the Dragstab. Actually, the Dragstab was created when I wanted to slap together a rocket but was too lazy to cut, sand, glue and finish a set of fins. Instead of fins, the rocket has a small streamer mounted on the rear of the rocket (with adequate protection from the engine blast). The drag of the streamer pulls the rear of the rocket in a downward direction. If the rocket is disturbed so that it rotates, (It will always rotate about its center of gravity.) part of the drag force acts to restore the rocket to its original trajectory. (The rest of the force just acts to slow the rocket down slightly.)

Begin construction by cutting the body tubes and wire to the lengths shown. The diameter of the music wire (approximately .05 inches) is not critical, but it should be stiff enough to resist bending from the forces at take-off. Bend the wire as shown, keeping the front bend as short as possible, so that the ejection cap is not impeded. The bent wire acts as an engine retainer. The rear bend should leave slightly more wire at the end than one diameter of the body tube. The wire will go completely through the body tube. Align the wire in the body tube holes and apply about 1 1/2 turns of masking tape over the wire, where shown, on the front and rear body tubes. Two parallel wires can be used instead of one, to improve

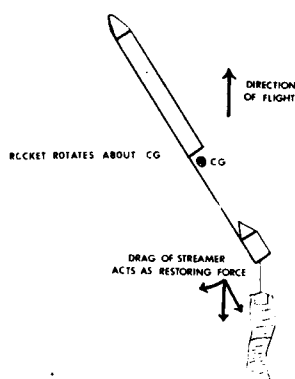

How the Dragstab Works

rigidity. Place them opposite each other on the body tubes and attach in the same manner.

To make the lower body blast deflector, copy the pattern onto sheet metal from a tin can. Using needle-nose pliers, bend the deflector into a conical shape with the small tab inside. Now bend the small tabs around the perimeter until you achieve a tight fit on the body tube. It may be necessary to cut a small triangular piece out of the edge of the cone to allow the deflector to fit around the structure wire.

If the job is done correctly, the streamer is attached to the structure wire with a 10 cm. string leader. Tie the leader securely to the wire and dab the knot with glue. Put a length of masking tape over one end of the streamer. Then, punch a small hole in the masking tape and tie the leader to this. A 25 cm streamer of standard width (5 cm) will do nicely. I found that a 15 cm streamer is about as small as you can

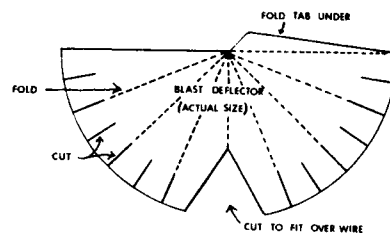

The Blast Deflector

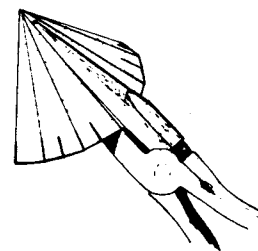

Bend the deflector into a conical shape using needle nose pliers.



Bend the tabs around the perimeter to achieve a tight fit on the body tube.

The Dragstab

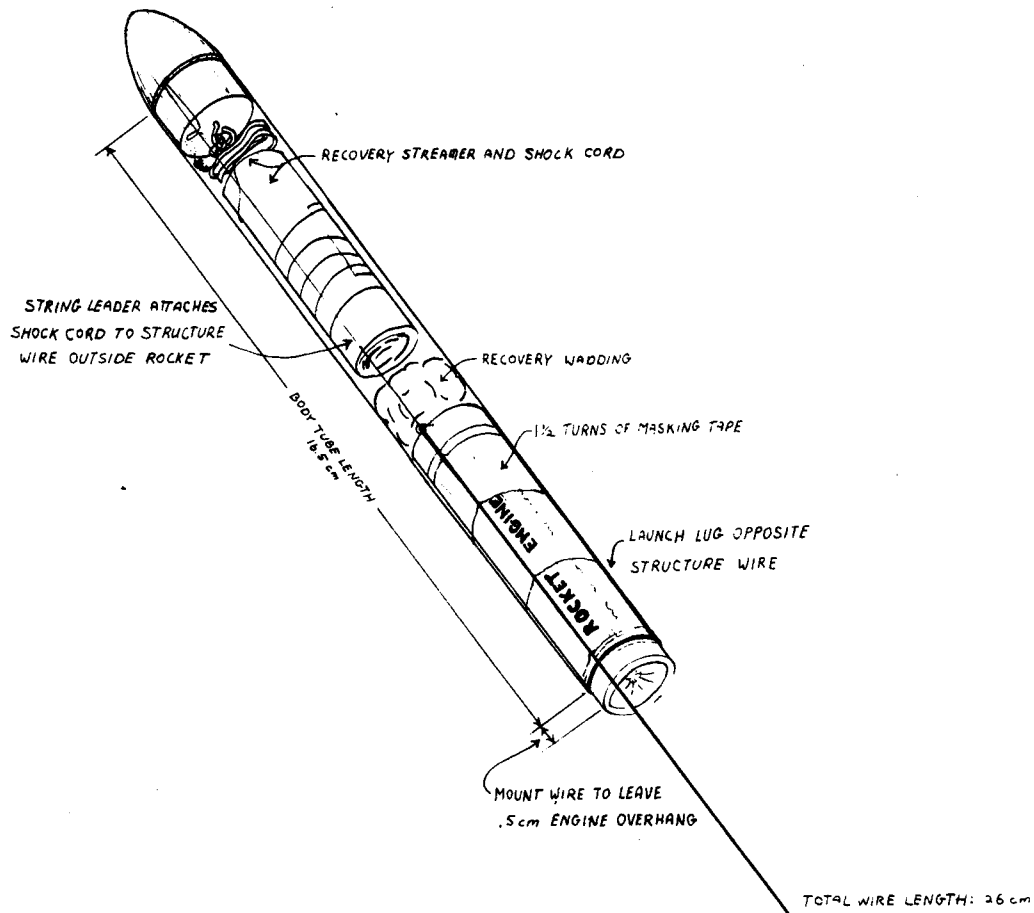

The Recovery System for the Dragstab

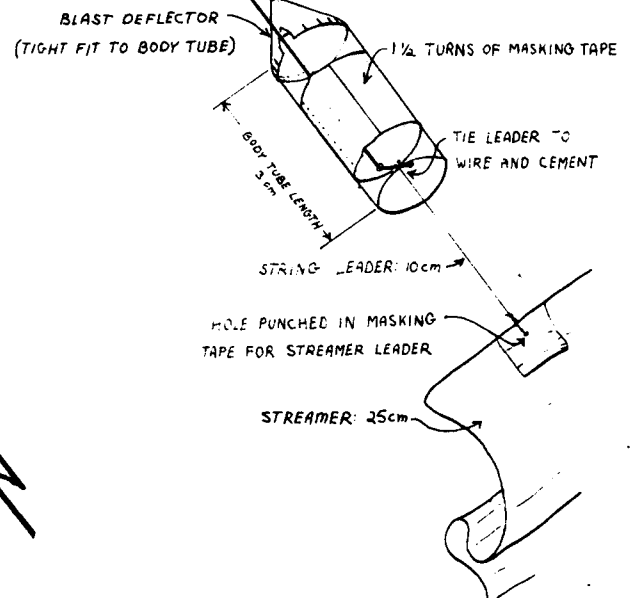
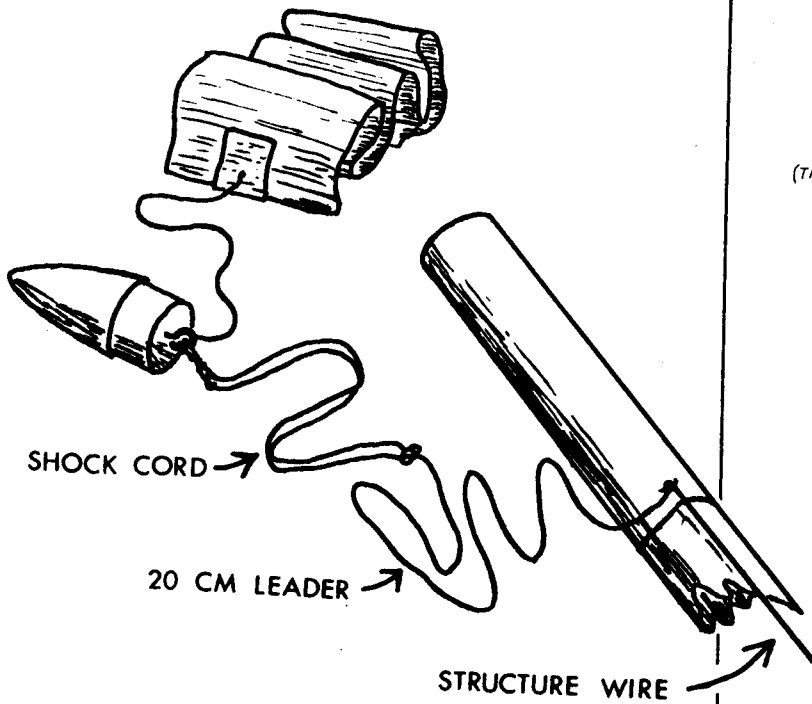

get without dangerous oscillations in the flight.

Apply a piece of masking tape over the recovery streamer and punch a hole in it, as in the drag streamer. Tie a short leader to the streamer and the nose cone screw eye. Secure the shock cord to the screw eye. Attach the other end of the shock cord to another leader string about 20 cm long. Form a space under the structure wire with a pin at the wire bend on the forward body tube. Push the leader through this space and tie securely to the structure wire. When launching, install wadding in the body tube, insert the streamer, and put in the shock cord. Pull this leader string taut and install the nose cone, which keeps the string taut.

And, of course, don't forget to glue on a launch lug (opposite the structure wire).

Finish the rocket in your favorite coating material. Masking tape can be covered nicely, but it will take some coating if you want a gloss shine. Don't attempt to paint the blast deflector or structure wire between the body tubes. They will be charred after every flight, but can be kept shining with a little steel wool.

Launching may be a little tricky. Position the Dragstab on a standoff. An old engine casing slid over the launch rod makes an excellent standoff. Fold the drag streamer back and forth in an accordian pattern, keeping the folds about 4 cm long, and set it on your launcher under the launch rod. Be certain that the streamer will not tangle in the standoff or other launcher apparatus. Position the igniter clips so that when they fall they will not get caught in the lower structure. Generally, the tension on the wires and the weight of the clips will pull the clips out of the way. A simple system of dowels to support the leads may be necessary. Hinge a dowel or dowels vertically on the launcher with tape. Then tape the leads to the dowels. The weight of the leads will pull the dowels out and down after ignition. If all else fails, you can be certain of keeping the clips out of the rocket by using a fuse with electrical ignition. Insert a long enough fuse in the engine so that the igniter and clips can be positioned well away from the rocket structure.

The best engines for the Dragstab are engines with short delay charges, due to the extra drag and short flights of the rocket. $\frac{1}{4}$ A6-2, A5-2, and B4-4 engines are best, though longer delay B's and C's may have success. Attempts have been made to test the feasibility of using series II core-

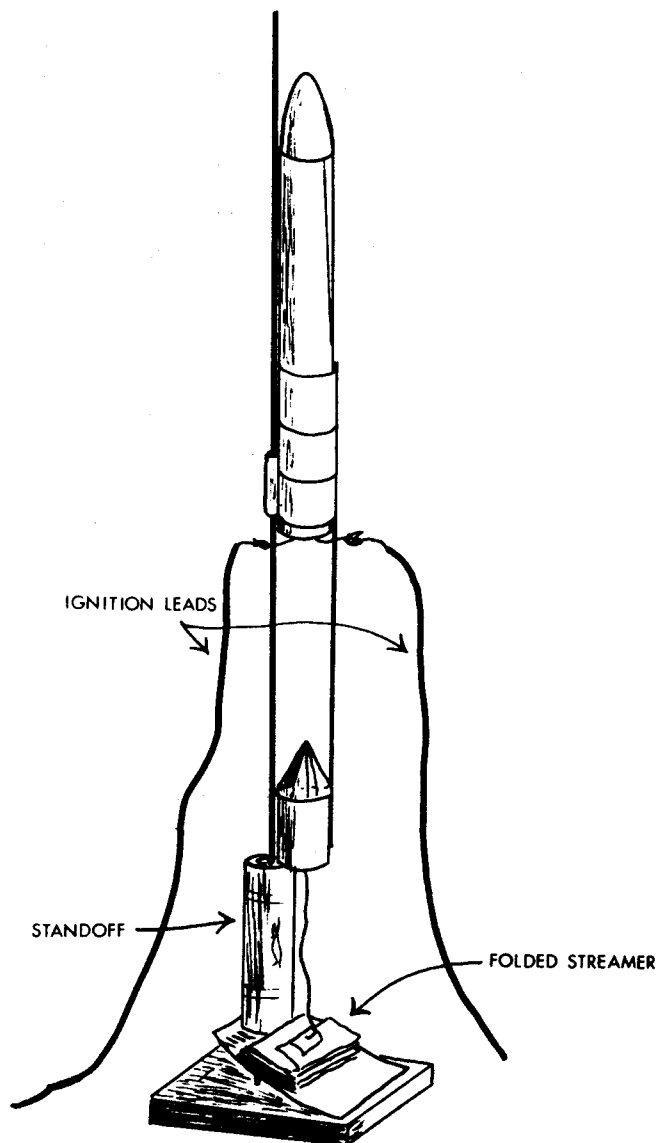

Launching Setup for the Dragstab

burning engines with the Dragstab. However, there appears to be a tendency for the drag streamer to shred upon take-off!

The basic Dragstab will permit many model rocket variations because it

gets rid of the problems of fins. (For one thing, it's a lot easier to pack and store!) Just don't get caught trying to design an altitude bird this way, just to get rid of the drag of the fins!

COMING NEXT MONTH...

- Flexwing Boost Gliders
- How to improve your Camroc
- Scale: MT-135 Japanese Sounding Rocket
- Dynamics—Part II
- Calculating Drag Coefficients

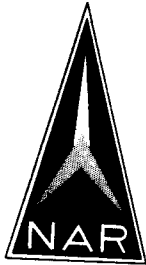

National Association of Rocketry

Within the relatively short time of ten years, model rocketry has come into its own. The week of August 19-23, 1968, saw the tenth annual United States model rocket championships held at NASA Wallops Island Station. From a very modest beginning in the United States, model rocketry has taken on international educational and scientific proportions.

Early kits and supplies for model rocketry were available from one small manufacturer. Today there are no less than four major manufacturers of kits, engines and supplies, with other very interested enterprisers ready to enter the field. One can only see a continued expansion in the area of manufacturing of model rocket supplies.

Publications in model rocketry have been many and varied to date. Probably the earliest publication was the Model Rocketeer, the organ of the National Association of Rocketry. Technical aspects of model rocketry have been covered in house publications of the manufacturers. In addition, in recent years, the National Association of Rocketry has had a section in the American Aircraft Modeler. The tenth anniversary of model rocketry is an opportune time to welcome a new publication to the field. Publication of Model Rocketry is an ambitious effort. The breadth of coverage from section and club news to highly technical reports should make the publication appealing to all levels of interest. To be a valuable publication, Model Rocketry must have the support and dialogue of all model rocketeers. Success is the byword for Model Rocketry. Congratulations!

Sincerely,

Ellsworth B. Beetch
Ellsworth B. Beetch
President, NAR

Wallops Station

by JACKSON S. ELLIOTT
NORTH AMERICAN AVIATION, INCORP.

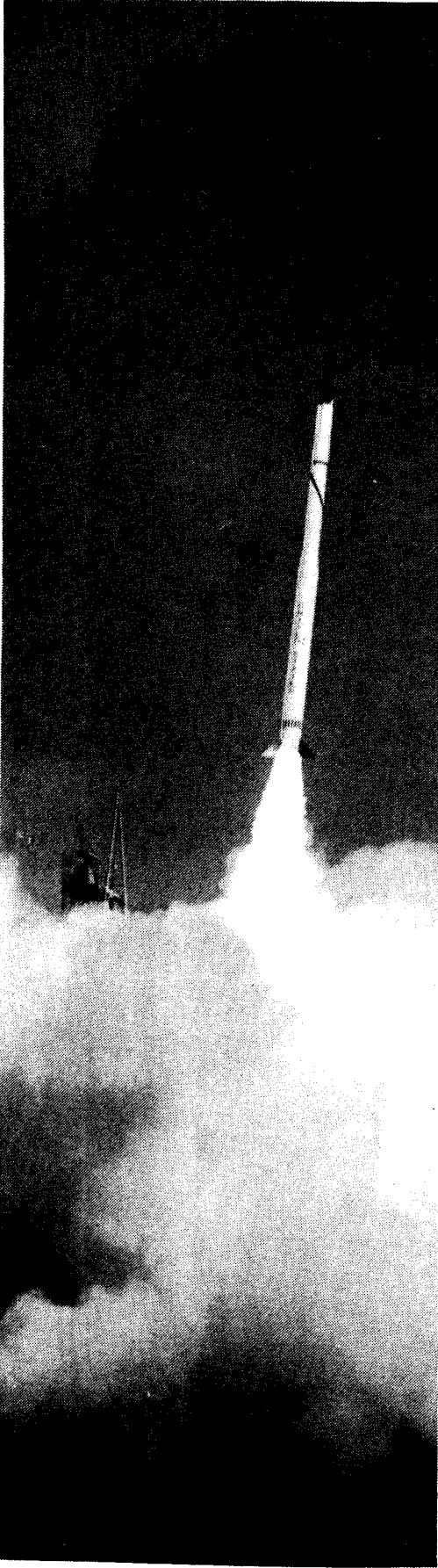

On a hard white ridge of sand and wiry grass, nearly five miles long at NASA's Wallops Island Station, Virginia, almost daily probing fingers are being extended into the upper sky through NASA's National Sounding Rocket Program. An undramatic name and, in one sense, an undramatic program. But were it not for Wallops, man might never return from his journey into space.

The tide has a great deal to do in determining the size of the launch area at Wallops. On the east is the pounding ocean; on the west is an endless stretch of green salt marshes cut by twisting channels of clear water.

Wallops is a service organization on the shores of the Atlantic, saying in effect to brother organizations within NASA, "Bring us your questions, we'll launch them and bring back your answers."

Here Goddard sends payloads into space; Langley Research Center launches its Scout vehicle experiments, Lewis augments its propulsion research. Over the years Wallops has pressed the button 4500 times in sending payloads into the sky. Scarcely a work day goes by at the ocean-side station that a new experiment does not roar aloft from the simple steel tripods and cranes that serve as launching platforms.

The whole keynote of the Wallops operation is that of economy—to get space experiments into the air at the least possible cost.

If it is possible to become matter-of-fact and routine in the conquest of space, Wallops has done so. It is based on practicality, a rule that was emphasized as early

as 1945 when the Station was opened by NACA, to find out why tried and true aircraft wing configurations were acting so strangely as they edged closer to the sonic barrier.

NACA fastened stubby sections of the wings to small rockets, shot them out over the Atlantic, and found the answer. It was in effect an extension of the wind tunnel and laboratory investigation into the flight of aircraft that were streaking at higher and higher speeds.

Years later when NASA took over from NACA in the small station only 180 miles southeast of Washington, Wallops was already deeply involved in the solution of hypersonic and space flight problems.

And, in order not to add to the growing load on the launch facilities down at Cape Canaveral, Wallops was selected as the site to carry on the bulk of the National Sounding Rocket Program.

Most of the sounding rockets are small—hip pocket size when compared to the Atlas, Saturn; miniscule when compared with the proposed Nova vehicle. Yet they are the only vehicles that can be used to make effective scientific investigations in the region from 20 to several hundred miles above the earth. Balloons can't carry payloads above the 20-mile ceiling; high-speed satellites are doomed to a fiery death when they start dipping below the 100-mile limit. The only effective weapon is the sleek, power-packed sounding rocket.

It roars up from the pad with all the spectacular flame and fury associated with its bigger brothers, spots its payload at the exact altitude and speed desired by the scientist waiting below, then falls off, its job done. With elevator-like regularity, sounding rockets are leaping from Wallops

Reprinted from SKYLINE (vol. 19, #4)
© by North American Aviation, Inc.

in exploratory investigations in geophysics and astronomy. They are testing prototype instrumentation that will be used later in the large satellites. They are compiling mountains of information for the space scientist, making measurements at the time, and within the limits, at the place he selects. Want to know the prevailing temperatures at 200,000 feet? A sounding rocket will get the answer. The chemistry of the atmosphere there? A sounding rocket will tell.

The simplicity of installation at Wallops and the rockets used permits the scientist to move quickly when he wants some desired information. A short time ago a particularly fascinating tongue of flame shot out from the sun, traveling toward the earth at the speed of a thousand miles a second—part of an unusually violent solar flare. With very little preliminary preparation Wallops, at the direction of one of the scientific investigators, shot a sounding rocket into the path of the fiery furnace—and picked up invaluable on-the-spot information. Mobility of the operations permitted the quick launch.

For most of its launchings Wallops uses existing off-the-shelf rockets already in use by the military—Honest John and the Nike boosters are frequently used as the muscles in the first and second stages of the multi-stage vehicles darting up from Virginia sands. Most of the combinations

are given code names, but few of them reach the prominence of the giants that leap from Cape Canaveral, hundreds of miles to the south. Argo D-4, for instance, is the name of a four-stage combination that features an Honest John in the first stage, two Nikes in the second and third, and an X-248 in the fourth stage. The name, Argo D-4, hasn't reached the billboard prominence of the Thor-Agena, but some of the results obtained are almost as spectacular.

Sodium Cloud

An Argo D-4 has many times carried to 50 to 200 miles altitude a 172 pound payload of sodium. The sodium was ignited by a thermite charge, a massive reddish cloud was formed in the night sky, and an audience of millions ranging for hundreds of miles along the Atlantic seaboard watched the red ball of fire. Fearful to some as perhaps "the end of the world," it was in reality a painstaking scientific experiment designed to measure the wind diffusion and the temperatures at high altitudes.

The vast majority of work performed at Wallops involves probes—small payloads that are carried to extremely high altitudes before plunging back to earth. Practically no attempt is made to recover payloads. In one odd re-entry study, a seven-stage rocket was boosted by the first three stages to an altitude of 175 miles

above the earth. The rocket coasted onward, slowed, then nosed downward toward the earth. Then the four remaining stages cut in one after the other, sending the re-entry pellet screaming to earth in a steel-consuming 25,000 mile-per-hour dive, an artificial meteor that provided an excellent basis of study for the scientists watching below.

Perhaps the best-publicized launch from Wallops was the series of Little Joe boosters used to test the Mercury escape capsules. It was on Little Joe that the abort system was proven; and the stubby rocket gained further fame with the rides of the monkeys, Sam and Miss Sam, hurled down range in the first proof that an astronaut could ride a Mercury capsule into space and survive.

There have been earth orbit satellite launches from Wallops, all of them involving the 72-foot Scout launch vehicle. The Scout is the first all-solid propellant launch vehicle to place a satellite in orbit. When it roared up from Wallops on February 16, 1961, it was the first time an orbit had been achieved by an American space vehicle other than from Cape Canaveral or Pacific Missile Range.

So at Wallops are being posed many of the questions the big quest develops. And from Wallops are coming the answers that will move the builders along to their next steps.

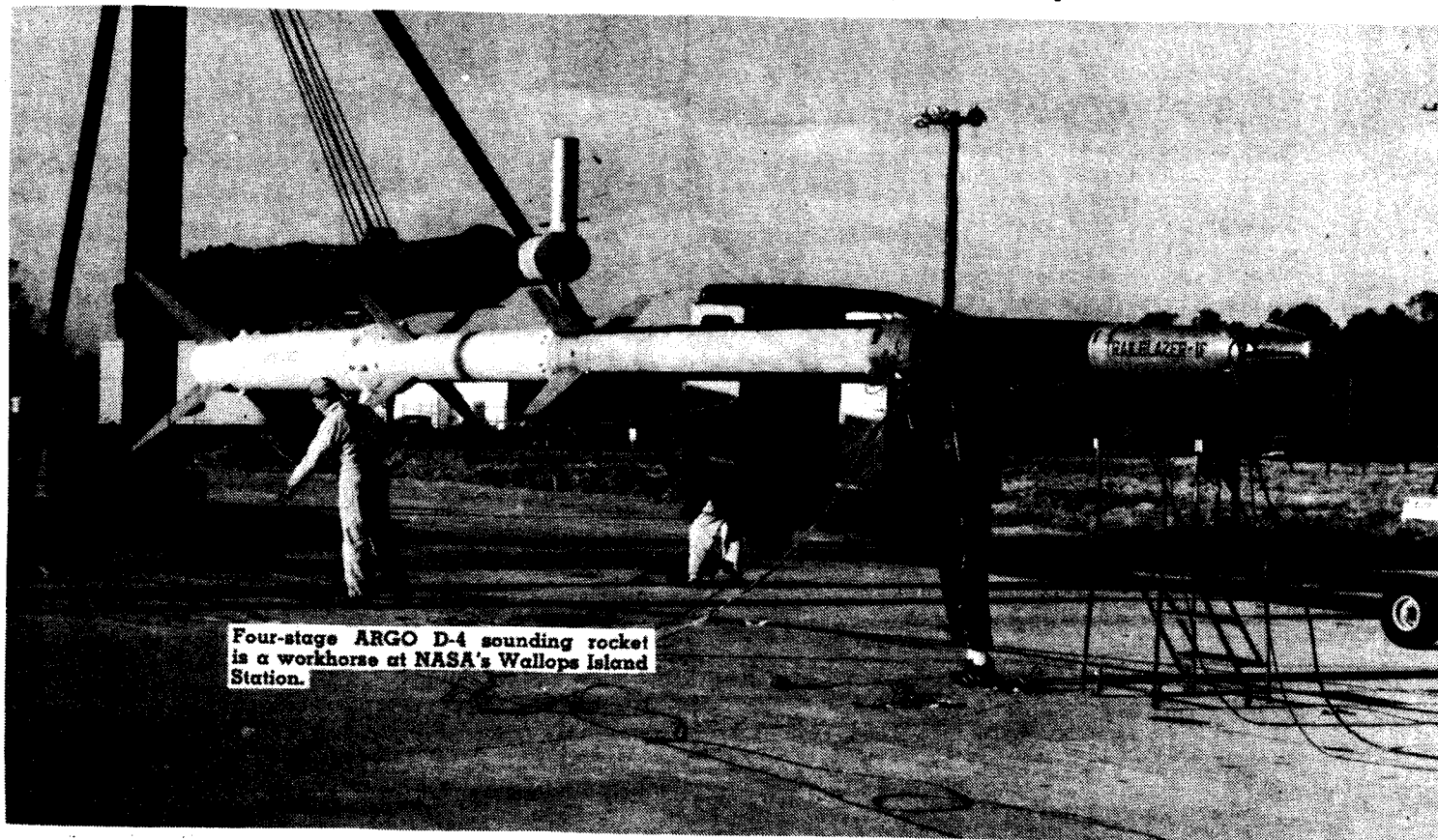

Four-stage ARGO D-4 sounding rocket is a workhorse at NASA's Wallops Island Station.

BALSA NOSE CONE
(ESTES BNC-20N)

.12 OZ NOSE WEIGHT
(ESTES 651-NCW-1)

SPIRAL WOUND BODY
TUBE (ESTES BT-20D)

12" PARACHUTE

RUBBER SHOCK CORD

PAPER-GLUE WAD

PAPER ENGINE BLOCK

B.8-6 OR B3-5

GRAIN

3 FINS: 120°

$\frac{1}{16}$ " THICK BALSA

.710"

2.75"

6.50"

APEX I:

A HIGH ALTITUDE SINGLE STAGE ROCKET

by GEORGE J. CAPORASO

Many factors enter into the design of a high performance, altitude rocket. There are questions of static and dynamic stability, dynamic oscillations, drag, thrust and weight.

From a dynamical standpoint, it is desirable to have the rocket undergo damped oscillations if deflected by wind or misaligned fins, etc. If the conditions for a damped oscillation to occur are met by the rocket in question, the rocket will wobble in flight after the initial deflection and the oscillations will eventually die down to a point where the rocket is once again travelling in a straight flight path or trajectory. The rocket oscillations should be minimized because the wobbling of the rocket in flight increases the effective drag on the rocket above that for a rocket undergoing no oscillatory motion.

The rocket of course must be statically stable; that is, the center of gravity must be ahead of the center of pressure by at least one body diameter. If this condition is not met, the rocket will spiral nose over tail as soon as it leaves the launch rod.

At the same time, the drag coefficient must be minimized as much as possible. Many factors contribute to the drag of a model rocket. Skin friction along the body tube and fins usually form the largest single component of the total rocket drag. Pressure and base drag form the next largest component. In addition, oscillations of the rocket will cause the rocket to present a greater cross-sectional area to the airflow and will thus increase drag. Interference drag at the fin joints and launch lug are usually significant.

Considering the rocket merely as a point particle, that is undergoing no oscillations, we can arrive at a quite complicated set of solutions for the

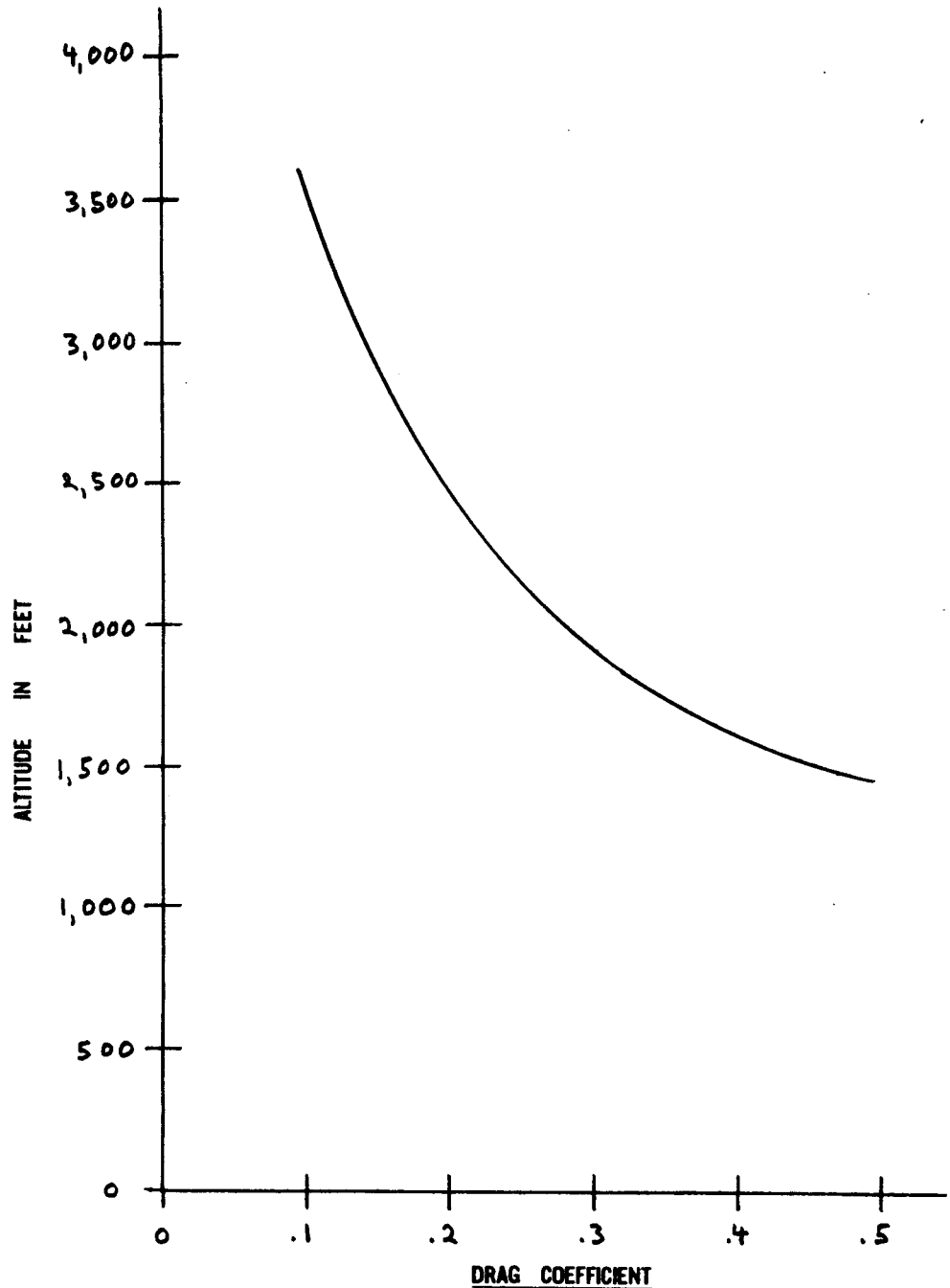

ALTITUDE OF APEX I VS. DRAG COEFFICIENT FOR A B.8-6 ENGINE

velocity and altitude of a model rocket. Plots of these solutions show that there is an optimum weight for the rocket to achieve maximum altitude; not merely the lower the weight the higher the altitude. For rockets on the order of an ounce, a point is reached as the weight is lowered where the rocket's momentum is rapidly dissipated by drag when the rocket is coasting. As the initial weight is lowered, the burn-out velocity increases and the drag becomes so large relative to the weight of the rocket that its coasted distance becomes very small. On the other hand, if the weight is too great, the rocket will not achieve a high burnout velocity and will not coast very far. Thus there is an optimum weight.

The Apex I is a simple, single stage rocket using a B engine with a six second time delay. Its initial weight has been optimized on a computer. It is statically stable and possesses the desired characteristic of undergoing damped oscillations if forced by wind or misaligned fins.

As can be seen by referring to the accompanying graph, the altitude is extremely sensitive to the drag coefficient. It is estimated by the author that a well constructed and well finished version of the Apex I could have a drag coefficient of about .35 which would give an approximate altitude of 1,700 feet. The graph does not take into account the reduction of altitude due to oscillations or the variation in drag coefficient of the rocket with velocity. The graph only represents an idealized situation.

The choice of the nose cone reflects the fact that parabolic nose cones have the least pressure drag of any shape. There are also only three fins instead of four to reduce both friction drag and interference drag at the fin joints. The gradual taper on the leading edge of the fins also helps to reduce interference drag. The side edges of the fins are shaped in order to reduce the vortex drag at the side and back of the fins. The trailing edge is also gradually tapered to reduce vortex and interference drag at the end of the rocket.

The Apex I can be flown with $\frac{1}{4}$ A, $\frac{1}{2}$ A, 1A or B engines but achieves maximum altitude with a B.8-6. It will achieve about 150 feet less altitude with a B3-6 and will be much more difficult to follow since the burn-out velocity will be in excess of 800 feet per second and the average acceleration will be about 80 g's. Unless the rocket is soundly and sturdily constructed, it will fly apart with a B3-6.

The parts shown in the accompanying diagram can be purchased at practically all of the leading model rocket manufacturing companies. A twelve inch parachute will be quite sufficient unless you want to see your Apex drift to the next continent!

Note especially the .12 ounce nose weight that is attached to the nose cone by the screw eye. The parachute is constructed in the standard manner and the shroud lines tied to the screw eye. The shock cord (1/8" wide) should be glued to a folded piece of paper (folded many times with the shock cord inside) which is then glued with duco-cement, white glue, or Ambroid to the inside of the rocket just above the paper nose block for the engine. The engine block should be inserted so that the nozzle end of the engine is just flush with the end of the body tube.

Cut 3 fins from 1/16 inch thick balsa as shown and sand them down to the finished shape. Round the leading edge and taper the trailing edges. Put a fillet of white glue along each fin joint to reduce interference drag and to strengthen the fin.

For best results on the finish, seal the nose cone with balsa fillercoat or sanding sealer several times and sand until a glossy finish is obtained. Then repeat the procedure on the fins. Sand the body tube with fine sandpaper, clean the dust away with a cloth and apply a white base color of dope.

Either brush on or spray dope can be used but spray dope gives much better results. After the white base color has

been applied, put on the final colors using spray dope.

Unless you are skilled at spray painting, it is advisable to practice on a scrap piece of body tube before attempting to paint the model. Hold the spray can about 8 to 10 inches away from the tube and move back and forth in an even motion. It is much better to apply many thin coats than one heavy coat which may drip or run.

After the paint has dried apply rubbing compound and wax to the nose cone and fins until they are mirror-like. This added touch should insure that the boundary layer of air that surrounds the model in flight will cling smoothly to the nose cone and fins and thus minimize drag. When the boundary layer hits the nose cone joint it will become turbulent and cause a relatively high amount of friction drag along the rest of the body tube. The wax on the nose cone is to forestall the transition to turbulence as long as possible. Since the boundary layer is only about a thousandth of an inch thick along the nose cone and fins, the degree of smoothness of the surface can be appreciated.

The Apex can be used in altitude competition, in payload competition, or in parachute duration. For the standard payload competition, remove the .12 ounce nose weight and just use the payload in the nose. For parachute duration, the nose weight must stay in and the 12 inch parachute replaced with an 18 inch.

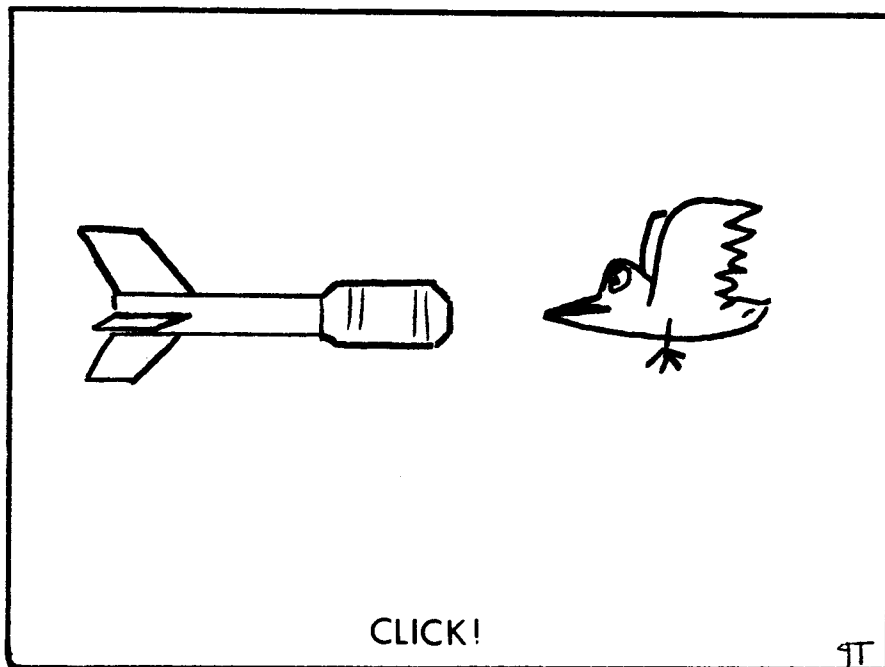

MODEL ROCKET ALTITUDE CALCULATIONS

by GEORGE J. CAPORASO

The problem of calculating the altitude of a model rocket is a highly complex one. The sheer abundance of factors involved makes an exact, closed form analytic solution impossible. However, the problem can be solved to any required degree of accuracy by iterations on a digital computer.

Such a procedure is easily carried out by professional designers at N.A.S.A. but is, unfortunately, impractical for the model rocketeer. Therefore, it is desirable to have an easily handles closed form approximation to the altitude solution which can be used for any model rocket size, weight and engine.

Such an approximation was derived by the author in the spring of 1966 at M.I.T. Its validity was tested against the Fehskens-Malewicki solution and against computer iterations using varying mass and thrust functions for a wide assortment of initial weights, drag characteristics and engines. The approximation equations were found to agree with the iterations to within 1.5%; just as good or better than the Fehskens-Malewicki solutions.

Of course, the present treatment excludes the effect of oscillations which are always present. We hope to present an article at a later date which will contain a complete treatment of the coupling of oscillations to the altitude equation.

The derivation of the equations is given in figures 1 and 2.

Here, F denotes the average thrust in ounces, m the average mass in ounces-sec²/ft² which is found by dividing the average weight in ounces by g which is 32.2 ft/sec². m_b is the burnout mass of the rocket which is found by dividing the burnout weight by g . V_b is the burnout velocity in feet per sec., X_b is the burnout altitude in ft., H_c and H_T are the coasted and total altitudes respectively; t_b is the burning time in sec.; t_c is the coasted time to apex from burnout in seconds; and k is the total drag factor in units of ounces-sec²/ft². The drag on a rocket is given by drag = $\rho A C_D V^2$ where ρ is the density of the air, A is the frontal cross-sectional area of the body

DERIVATION OF THE ALTITUDE APPROXIMATIONS

I. Powered Portion of Flight

$$F = \frac{dp}{dt} \quad \text{where } p \text{ is the rocket's momentum}$$

$$\frac{dp}{dt} = F(t) - m(t)g - kV^2$$

Now approximate $m(t)$ by m , $F(t)$ by F ; then

$$\frac{dp}{dt} = F - mg - kV^2 \quad \text{integrating both sides,}$$

$$\int_0^{t_b} \frac{dp}{dt} dt = \int_0^{t_b} F dt - \int_0^{t_b} mg dt - \int_0^{t_b} kV^2 dt$$

$$\text{Now } \int_0^{t_b} kV^2 dt = kXV \Big|_0^{t_b} - \int_0^{t_b} kXA dt$$

Approximate this integral by $kX_b V_b$ and $p_b = m_b V_b$ and

$$m_b V_b = Ft_b - mgt_b - kX_b V_b \quad \text{yielding}$$

$$V_b = \frac{t_b(F - mg)}{m_b + kX_b}$$

Now let V and t be variables and integrate again

$$\int_0^{t_b} m_b V dt = \int_0^{t_b} Ft dt - \int_0^{t_b} mgt dt - \int_0^{t_b} kXV dt$$

$$m_b X_b = \frac{Ft_b^2}{2} - \frac{mgt_b^2}{2} - \frac{kX_b^2}{2} \quad \text{which yields}$$

$$X_b = \frac{-m_b + \sqrt{m_b^2 + kt_b^2(F - mg)}}{k} \quad V_b = \frac{t_b(F - mg)}{\sqrt{m_b^2 + kt_b^2(F - mg)}}$$

II. After Burnout

$$\frac{dp}{dt} = -m_b g - kV^2 \quad \text{but since the mass is constant at } m_b,$$

$$\frac{m_b dv}{dt} = -m_b g - kV^2 \quad \text{now let } \frac{dv}{dt} = \frac{dx}{dt} \frac{dv}{dx} = \frac{v dv}{dx}$$

$$m_b v \frac{dv}{dx} = -m_b g - kV^2 \quad \text{and}$$

$$\int_{V_b}^0 \frac{m_b v dv}{m_b g - kV^2} = \int_{H_c}^0 dx \quad \text{which yields}$$

$$H_c = \frac{m_b}{2k} \ln \left(\frac{kV_b^2}{m_b g} + 1 \right)$$

the ln function is plotted in fig. 3. It is read as "the natural log of $\frac{kV_b^2}{m_b g} + 1$ "

FIGURE 1

tube in square inches, C_D is its dimensionless drag coefficient which depends on the shape and finish of the model and V is the velocity in ft/sec. Now $k = \rho A C_D / 1.54 \times 10^{-4} A C_D$; where the drag $\approx kV^2$.

The C_D for a model rocket can range from about .25 to perhaps .9, the typical figure being about .5. A report on calculating the C_D of any model rocket will be in next month's issue.

A typical altitude example is worked in fig. 5. Fig. 3 is a graph of the natural logarithm function in versus $kV^2/m_b g$. In fig. 4 is a plot of the arctangent function.

- 1 "Solutions of the Differential Equations of Ballistic Flight Paths for Model Rockets" by G. J. Caporaso, a paper presented to the 1968 M.I.T. Model Rocketry Convention.
- 2 "Calculating Model Rocket Performance" by G. J. Caporaso from TECH ENGINEERING NEWS, Oct., 1967.

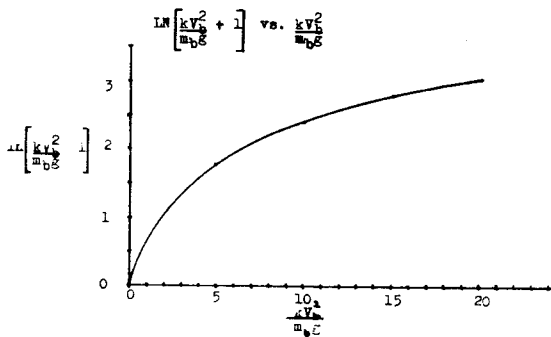

FIG. 3

III. Coasting Time

$$m_b \frac{dv}{dt} = -m_b g - kV^2$$

$$\int_0^{V_b} \frac{m_b dv}{m_b g - kV^2} = \int_0^{t_c} -dt \quad \text{which yields}$$

$$t_c = \sqrt{\frac{m_b}{gk}} \tan^{-1} \sqrt{\frac{k}{m_b g}} V_b$$

The \tan^{-1} function is read "the arctangent of $\sqrt{\frac{k}{m_b g}} V_b$ " and is the angle in radians whose tangent is the quantity in the above quotation. This function is plotted in figure 4.

Figure 2

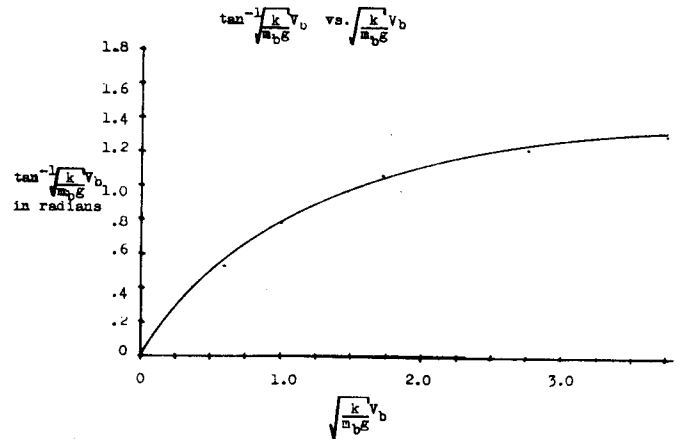

Figure 4

Sample Calculation

outside diameter	.710 inches
weight empty	.60 ounces
C_d	.5
k	3.05×10^{-5} ounces-sec ² /ft ²
g	32.2 ft/sec ²
t_b	1.4 seconds
Engine	B.8-6
F	12.8 ounces
Average weight of rocket	1.155 ounces
Burnout weight of rocket	1.020 ounces
m	.0359 ounces-sec ² /ft
m_b	.0317 ounces-sec ² /ft
A	.396 square inches

$$V_b = \frac{1.4(12.8 - 1.155)}{.0359 - 3.05 \times 10^{-5} \times 1.96(12.8 - 1.155)}$$

$$V_b = 366 \text{ ft/sec.} \quad H_c = 910 \text{ ft.}$$

$$X_b = 351 \text{ ft.} \quad H_t = 1261 \text{ ft.}$$

$$t_c = 6.25 \text{ sec.}$$

Figure 5

How to apply

DECALS

GEORGE FLYNN

No model rocket looks really complete without decals. They are a necessity on scale models, since the prototype will have some form of insignia or markings on it. But a decal or two, if applied properly, will do much to liven up the appearance of any model rocket. Correct choice of decal color can also increase the contrast of your rocket, allowing easier tracking. However, incorrectly applied decals tend to bubble, and the normal decal "halo" (the dull area which surrounds the decal) detracts from the glossy surface of the model. With a little effort, though, these problems can be eliminated.

Several types of decals can be obtained for your rockets. Standard Air Force star insignia are manufactured by several companies. Checkerboard patterns and stripes in various colors (red, black, white, gold and silver) are currently available. Letters and numbers for identification markings are also produced. These standard decals are available at most hobby shops, as well as from the large model rocket suppliers.

A few simple tools are necessary to apply decals correctly:

- a sharp pair of scissors or a sharp modeling knife,
- a small dish of warm water
- a pair of flat-end tweezers (the type sold for stamp collectors are very good),
- a good quality, soft artist's paintbrush,
- a jar of clear paint, compatible with the paint already on the rocket,
- a straightpin,
- rubbing alcohol,
- a soft clean rag,
- a jar of Solvaset,
- several sheets of white paper.

To apply decals successfully, the first rule is cleanliness. Spread out the white paper on the table or workbench, and place the model in the center of the paper. Clean the area where the decal is to be applied with a cloth dampened with rubbing alcohol. Then wait until the surface is dry. Make sure the

surface is clean and free from grease, glue or fingerprints.

In order to minimize "halo", the decal should be trimmed as close as possible to the design or lettering. Dip the decal in warm water for 15 to 30 seconds, until it is ready to come loose from the backing paper. Pick up the backing paper with the tweezers and locate it in the desired position on the model. Touch the corner of the decal with a clean rag, and slide the backing sheet out by pulling on it lightly with the tweezers.

While the decal is still wet, slide it into the final position with the tip of the tweezers. If the decal starts to dry out while it is being positioned use the paintbrush to apply a drop of warm water to it. Brush a layer of Solvaset

over the decal, to soften it. This softens the decal, and allows it to conform to any irregularities (such as rivet detail or grooves) in the model surface. When the decal is properly located, use a blotter or clean rag to absorb the remaining water from the surface. If there are any air bubbles under the decal, use the straightpin to prick a hole in the decal, and press down with the blotter to hold the decal against the surface.

Don't try to save time by letting several decals soak at once. After a decal separates from the backing material, the glue will begin to dissolve in the water. If this happens, the decal will not stick to the model.

After you have finished applying decals to the model set it aside to dry for at least 3 to 6 hours. As much as 12 hours drying time may be necessary in extremely humid weather. After drying, the "halo" can be eliminated by applying a thin coat of clear paint over the decal. The paint used should be tested for compatibility with both the decal and the paint already on the rocket. For example butyrate dope can not be applied over some decals.

If a little care is exercised the appearance of the rocket can be significantly improved through the application of decals.

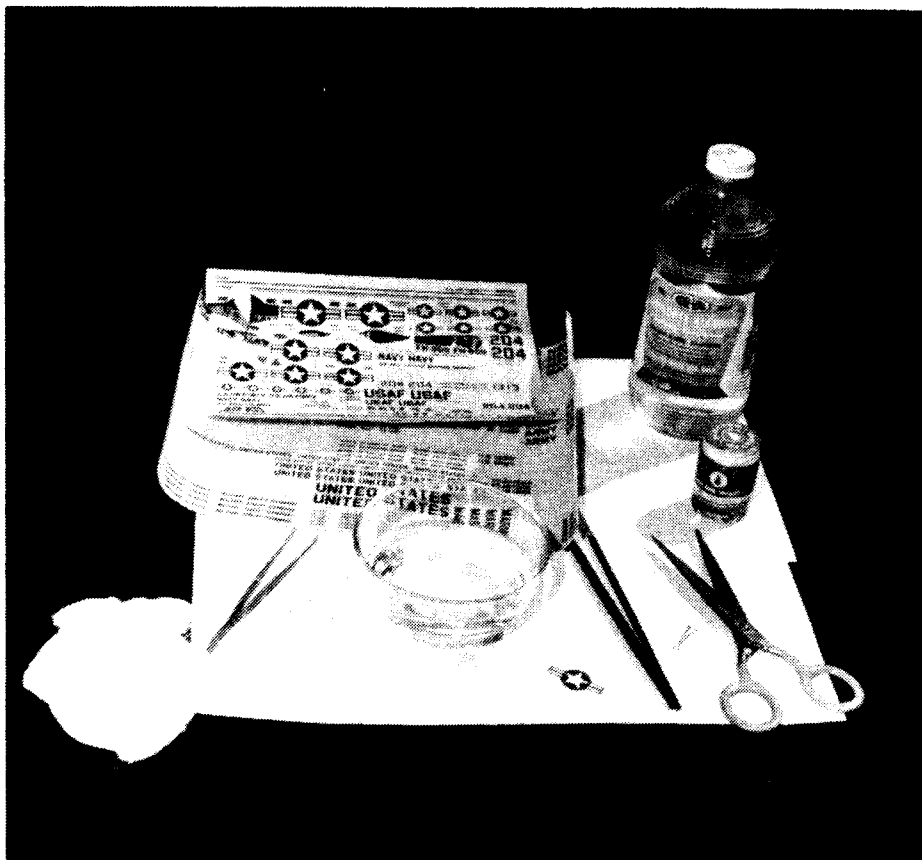

Only simple tools are necessary to apply decals correctly.

SCALE PLAN DESIGN: BOMARC B

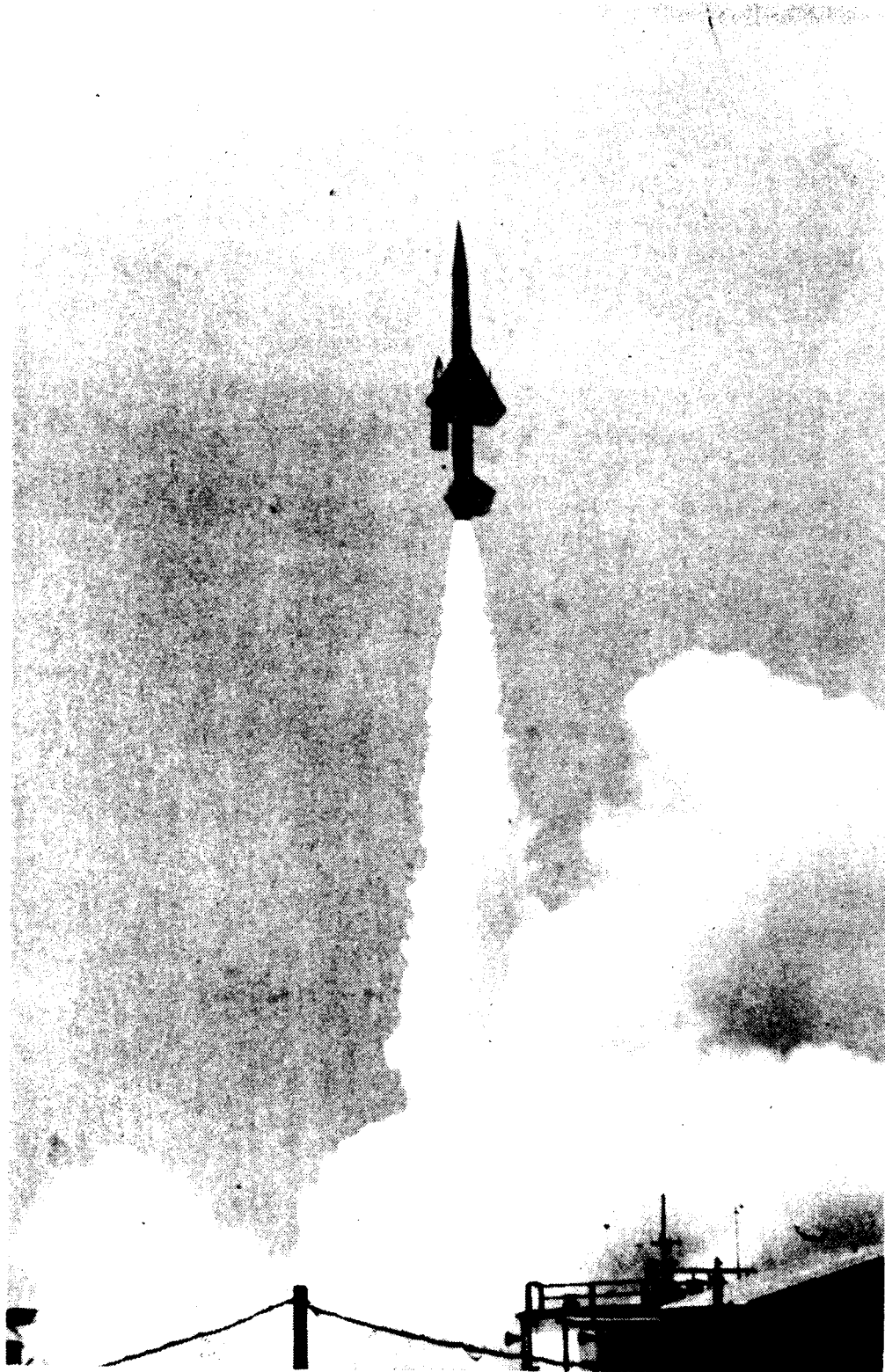

The Bomarc B is a surface-to-air interceptor which has been deployed since 1961. A 1/30 scale model of this missile can be constructed from commercially available parts, with very little modification. The plans on the next page are $\frac{1}{2}$ size if you choose to scale your model around a $\frac{3}{8}$ inch length of Centuri series #10 body tube. In this case, $2\frac{3}{4}$ inches series #8 body tube can be used for the rear section of the ramjets. $8\frac{1}{2}$ inches of series #5 body tube should be split in half lengthwise for the raceway.

The front raceway cone can easily be adapted from a Centuri BC-54 nose cone. This cone is first sanded to the correct shape (see figure 1), and then split in half lengthwise. The cone can be made to fit flush against the body by sanding it lengthwise with sandpaper wrapped around the body tube. A similar procedure is used to make the rear raceway cone, a BC-50.

Since no scale nose cone for the Bomarc is available, a BC-103 cone can be turned to the desired shape. This cone should be rough cut with a modeling knife. Then it can be chucked in a small electric drill and fine sanded to shape.

When using an electric drill as a lathe both safety and ease of operation require that the drill be securely fastened to the workbench. A drill stand, available at most hardware stores, is ideal for this purpose. (If you can't locate one, the Arco drill stand is available as part #14T1420 from Lafayette Radio Electronics, 111 Jericho Tpke, Syosset, New York, 11791 for \$1.29.) A $\frac{1}{4}$ inch hole should be drilled about 1 inch deep in the cen-

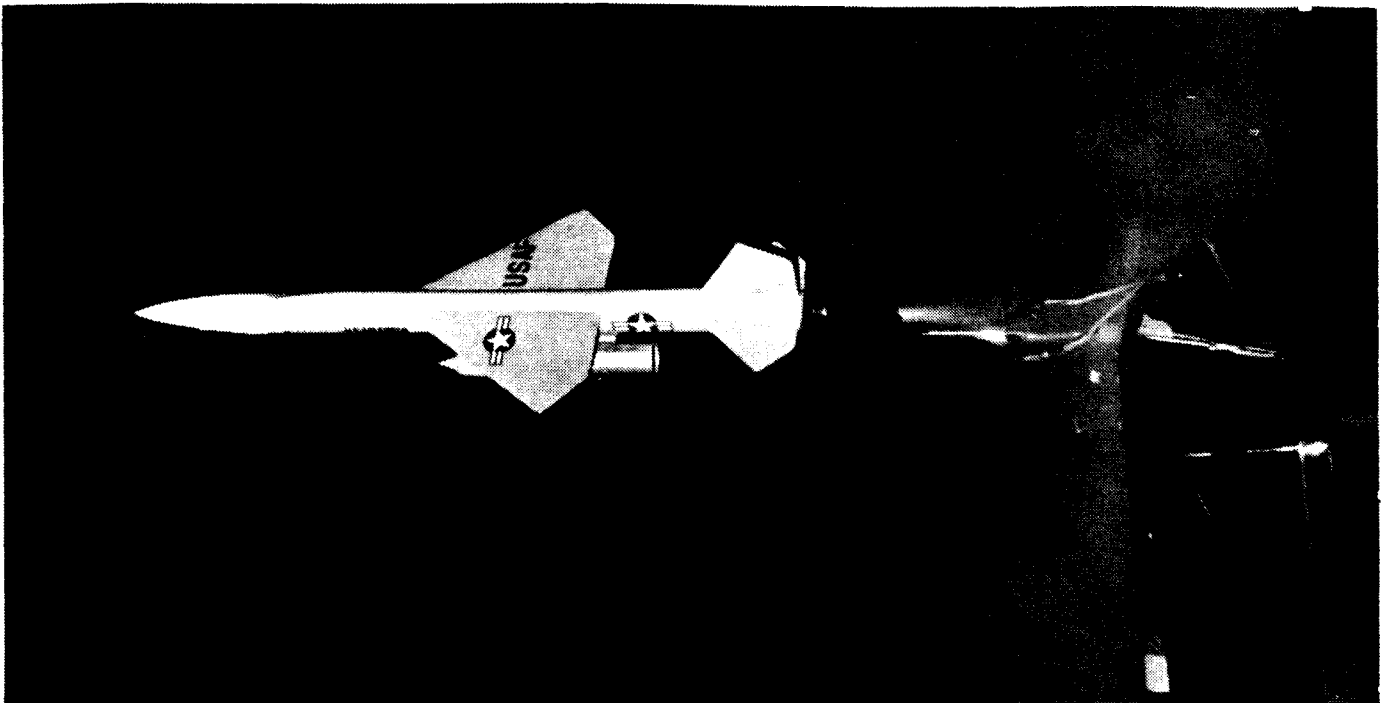

ter of the nose cone end, and a 2 inch long section of $\frac{1}{4}$ inch dowell glued in the hole. The dowell can then be chucked in the drill. The nose cone can then be sanded with a piece of sandpaper glued to a block of wood.

The front section of the ramjet engines must also be turned on a drill, as above, from pieces of scrap balsa. A large nail or small chisel can be used as a cutting tool if you are using an electric drill as a lathe.

The wings can be cut out of $\frac{1}{4}$ inch thick balsa, while the horizontal and vertical tail sections should be $\frac{1}{8}$ inch balsa.

This model should be powered by a single A, B, or C, rocket engine in the tail. The 18mm outer diameter of the engine makes it necessary to enlarge the engine tail cone by $\frac{3}{32}$ inch from what is shown on the scale plans.

Air Force star insignia and USAF decals to scale for this model are available in the air and Finishing Touch series. I have not yet found a U.S. Air Force decal to scale for this model, and the Boeing insignia on the vertical tail must be hand lettered.

Several different paint schemes were used during the Bomarc program. The early test models were painted black, with white stripes. However the colors called for on the plans are those of the mass production version.

This model has been flown successfully with A.8 and B.8 engines without additional nose weight. A single 18" parachute is sufficient for soft landings.

The Bomarc program was authorized by the U.S. Air Force in 1949. The contract to produce this weapon was given to the Boeing Aircraft Company. During the same year, announcement was made that the University of Michigan would participate in the early studies of this defense weapons system. It was from this combined effort that the Bomarc was derived - "BO" for Boeing and "MARC" for the Michigan Aeronautical Research Center.

Research and development on the most advanced version of the Bomarc, the Bomarc-B, began in 1958. This missile is a supersonic, surface-to-air interceptor designed to destroy enemy aircraft over 400 miles from its home base. This 16,000 lb missile is launched vertically from a permanent installation. A solid fuel Thiokol rocket engine in the tail accelerates the missile to a speed of several hundred miles per hour, then the Marguard RJ-43 ramjet sustainer engines under the wings take over.

Upon command from the weapons director at the nearest semi-automatic ground environment (SAGE) direction center, the shelter is opened and the missile is erected and fired. Once airborne, the SAGE computer in conjunction with an Interceptor Director (IND), guide the Bomarc through data link radio instructions to the vicinity of the hostile aircraft. Once in proximity with the target, the missile's own guidance equipment pinpoints and attacks the enemy - detonating its warhead at the closest point of interception.

The Bomarc-B is a 45 foot long, 30 inch diameter missile with an 18 foot wing span. It has a ceiling in excess of 70,000 feet, and cruises at a speed of about Mach 2.5.

Early testing of the Bomarc-B was at Cape Canaveral, but later Air Force testing took place at Eglin Air Force Base, Florida. A Bomarc B, launched from Eglin AFB in March 1961, successfully intercepted a simulated "enemy" supersonic target at 100,000 ft. over the Gulf of Mexico at a range of 446 statute miles.

In 1961 the U.S. Air Force declared the Bomarc B operational, and squadrons of 28 missiles each were deployed at 8 sites in the U.S. and Canada (Duluth, Minn.; Niagara Falls, N.Y.; Kinchloe AFB, Kinross, Mich.; Langley AFB, Hampton, Va.; McGuire AFB, Wrightstown, N.J.; Otis AFB, Falmouth, Mass.; North Bay, Ontario; and La Macaza, Quebec). Originally, additional squadrons of Bomarc's were planned, but with the decline in the threat of attack by manned bombers, the Bomarc program fell victim to severe budget cuts.

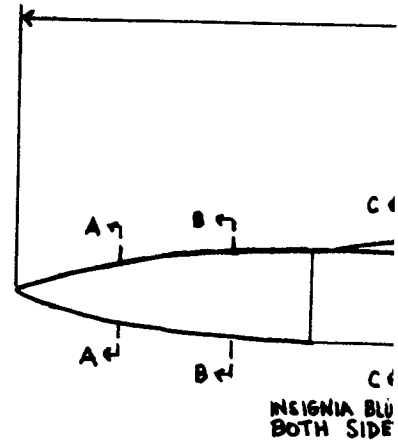
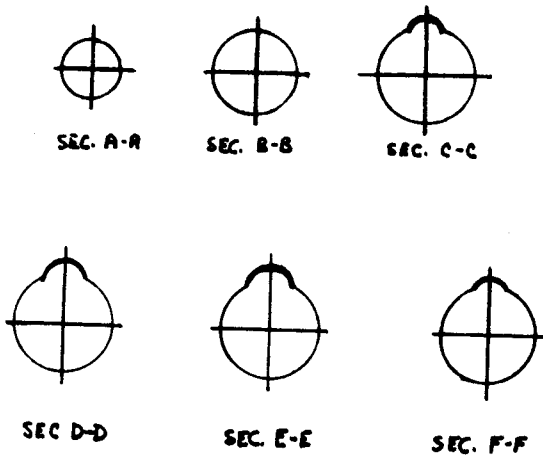
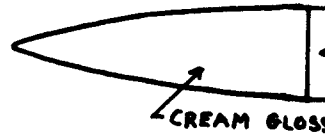
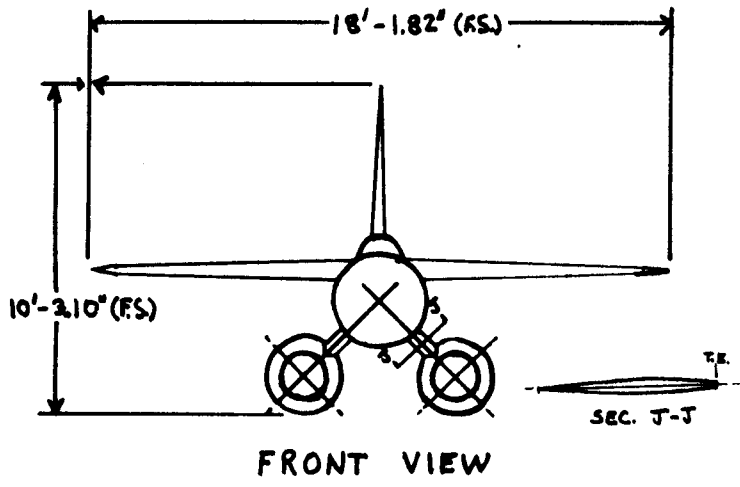

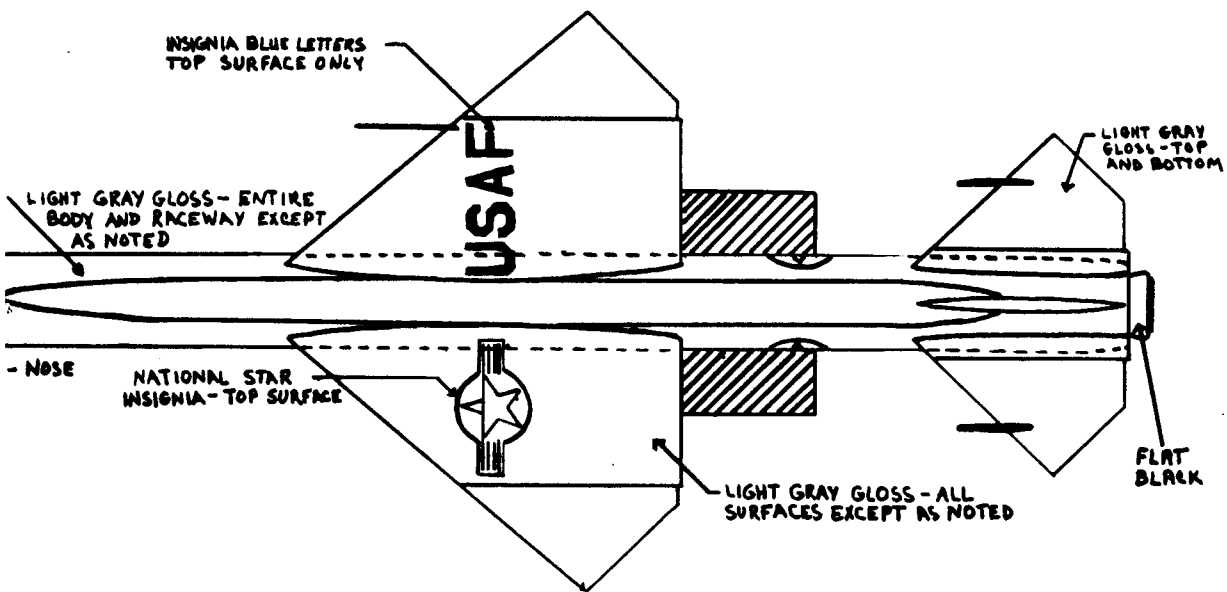

BOMARC IM-99B

- BOMARC B -

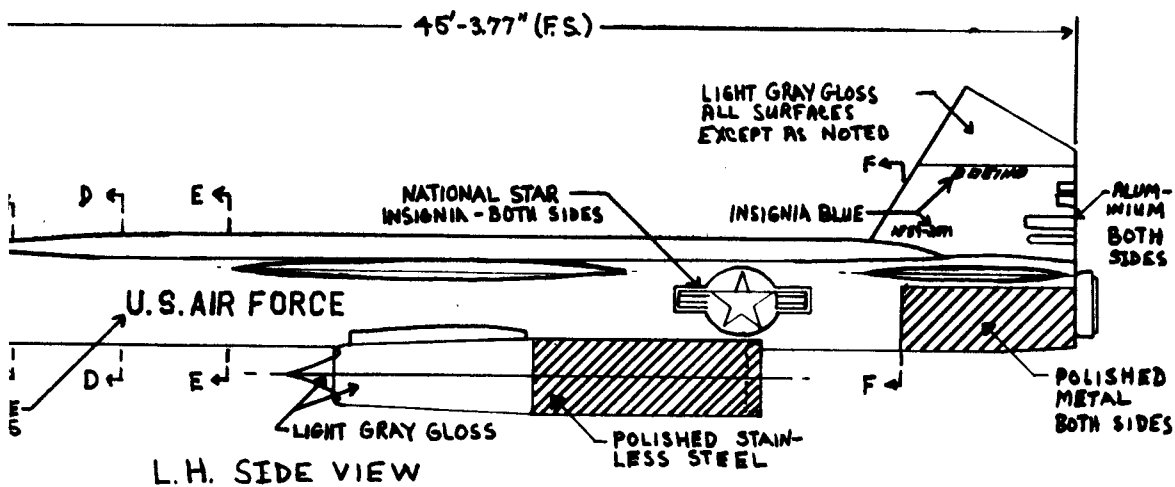

SCALE DATA OBTAINED FROM
BOEING COMPANY PLANS

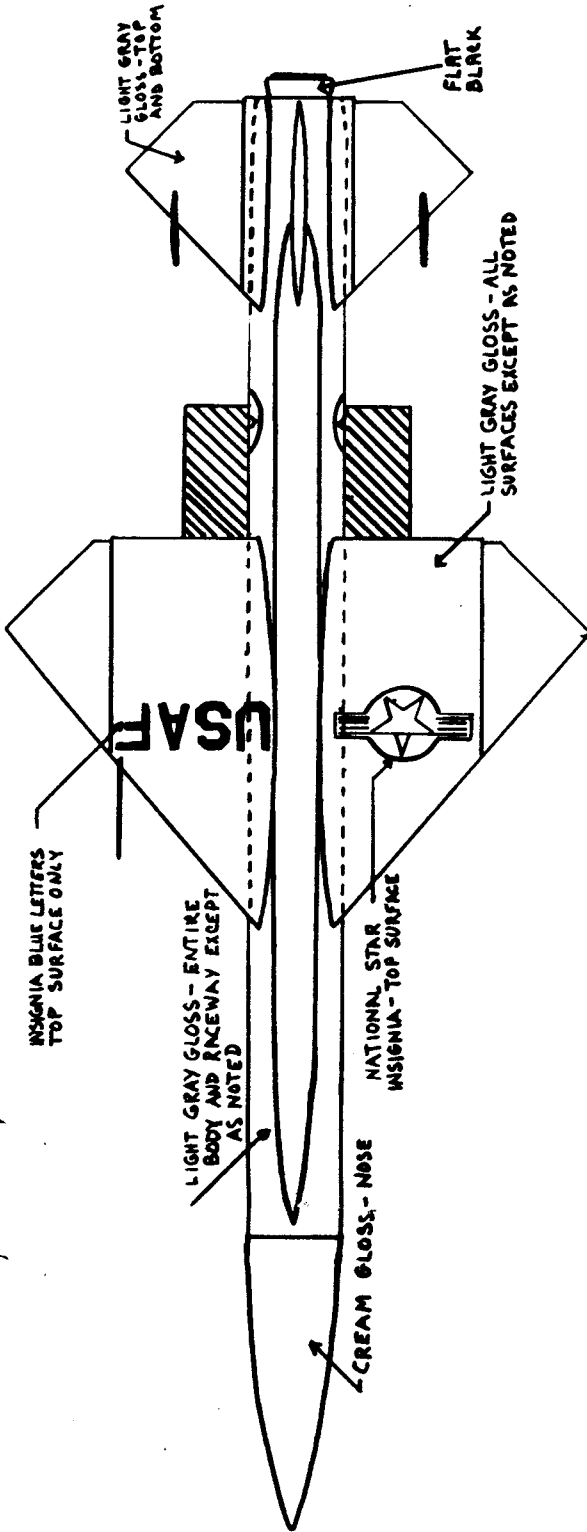

BOMARC IM-99B

-BOMARC B-

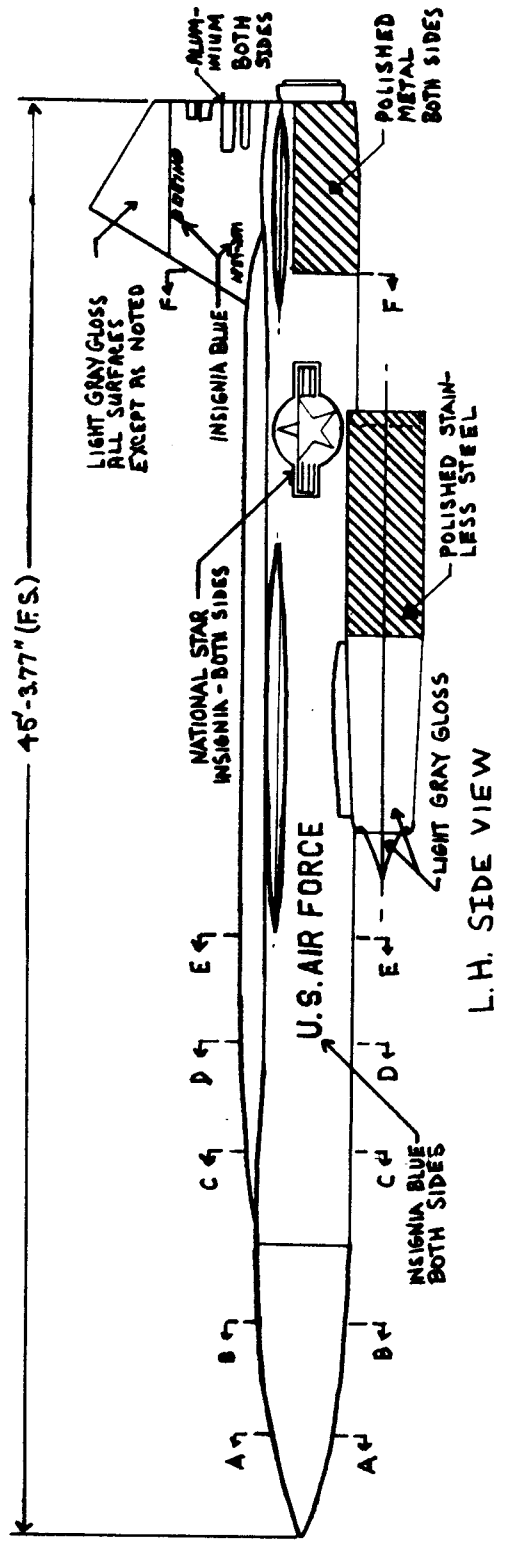

SCALE DATA OBTAINED FROM BOEING COMPANY PLANS

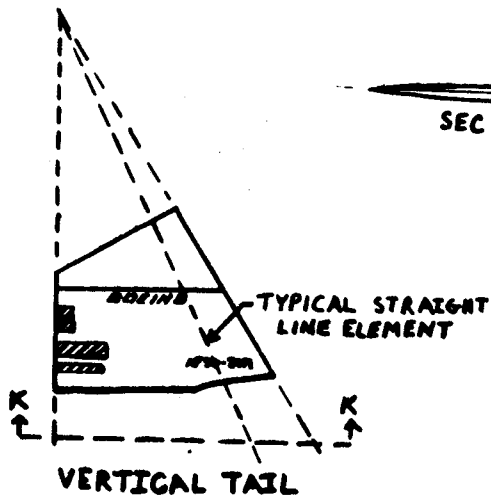

SEC. M-M

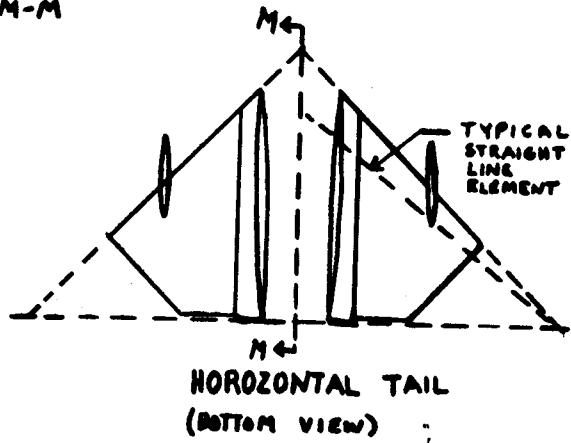

SEC. L-L

SEC. K-K

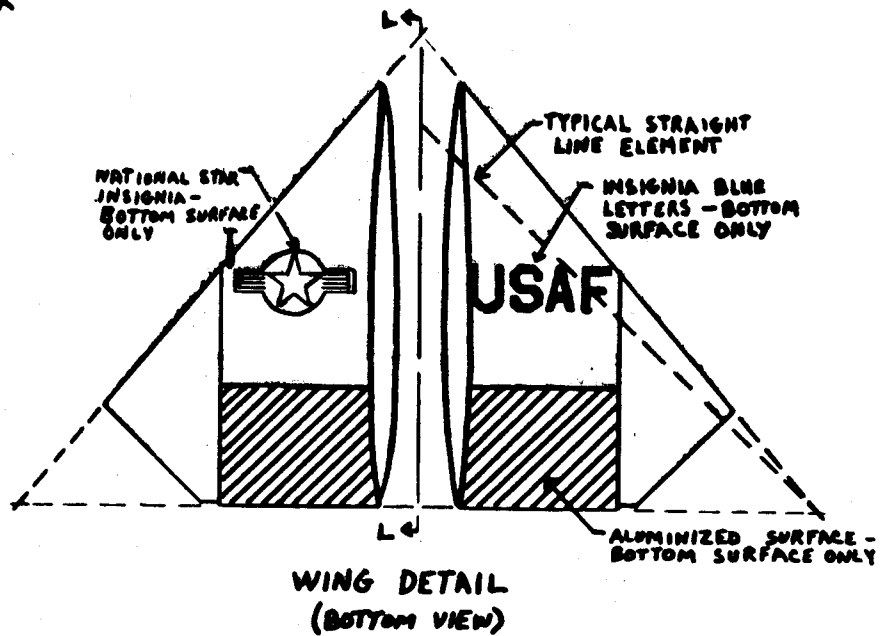

DON'T MISS OUT

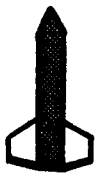
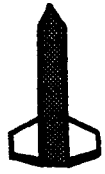

DON'T MISS OUT on any issues of the new MODEL ROCKETRY magazine—the only magazine for model rocketeers. Keep in touch with the rapidly expanding hobby-science of model rocketry. Read the latest news on NAR activities—local, regional, and national meets—construction plans—scale info—new materials and methods—math for rocket design—section news—special features—and more! **Subscribe today!**

Model Rocketry magazine

Subscription Dept.
MODEL ROCKETRY magazine
Box 214
Boston, Mass. 02123

Please send me (check one): The next 6 issues \$2.00
 The next 12 issues \$3.50

Name _____

Street _____

City _____

State _____ Zip Code _____

FREE SCALE PLANS

. . . for helping us make a better mag for you. Just fill out the following questionnaire and return to:

MODEL ROCKETRY
BOX 214
BOSTON, MASSACHUSETTS 02123

Scale plans will be sent to everyone who answers the questionnaire.

AgeYrs. as modeler Yrs. as rocketeer

Other hobbies

.....

What recent articles did you especially like?

.....

What articles did you dislike?

.....

About how much do you spend on hobby supplies per month?

Do you belong to a model rocket club?

Name

Address

.....

Is your club an NAR section?

Are you an NAR member?

Any comments about Model Rocketry.

.....

.....

.....

If you wish to receive free scale plans complete the following:

Name

Street

City

State Zip

NEW PRODUCT NEWS

The summer months brought new catalogs from all the major model rocket manufacturers. Each introduced several new kits. Perhaps the most impressive of all is the Little Joe II kit introduced by Centuri. This 23.4" long model is a 1/45th scale model of the solid fuel rocket used to test the Apollo capsule escape system. It's powered by a cluster of three engines. Centuri recommends either A.8-3's, B.8-2's, or B.8-4's. This model features pre-cut and pre-shaped balsa fins, pre-printed roll patterns and detail markings, a corrugated aluminized skin, and a molded plastic Apollo capsule. A booklet included with the kit gives historical information and pictures of the NASA Little Joe II. The scale data for this kit was supplied to Centuri by Al Kirchner, Jr., who has been modeling the Little Joe for several years. We've seen this one, and it looks like Centuri has taken a large step towards making scale modeling easier through the use of many pre-cut parts. The price, \$12.95.

From Estes comes the first commercially manufactured, pop-pod, boost-glider - the Nighthawk. Separating the power pod, gives the glider section minimum weight and drag, thus increasing flight duration. They recommend A.8-2, B.3-2 engines for this design. This 1.36 oz. boost glider is available from Estes for \$1.75.

From RDC we have the Starflight, a 186 gm (6.5 oz.) single stage rocket designed to be used with the RDC Enerjet-8 engine. This 24 inch long rocket is capable of flights to 3,000 feet if built carefully. The Starflight kit, with two Enerjet-8 engines is available from RDC for \$11.75 plus freight charges.

Join the NAR

Fundamentals of Dynamic Stability

Gordon K. Mandell

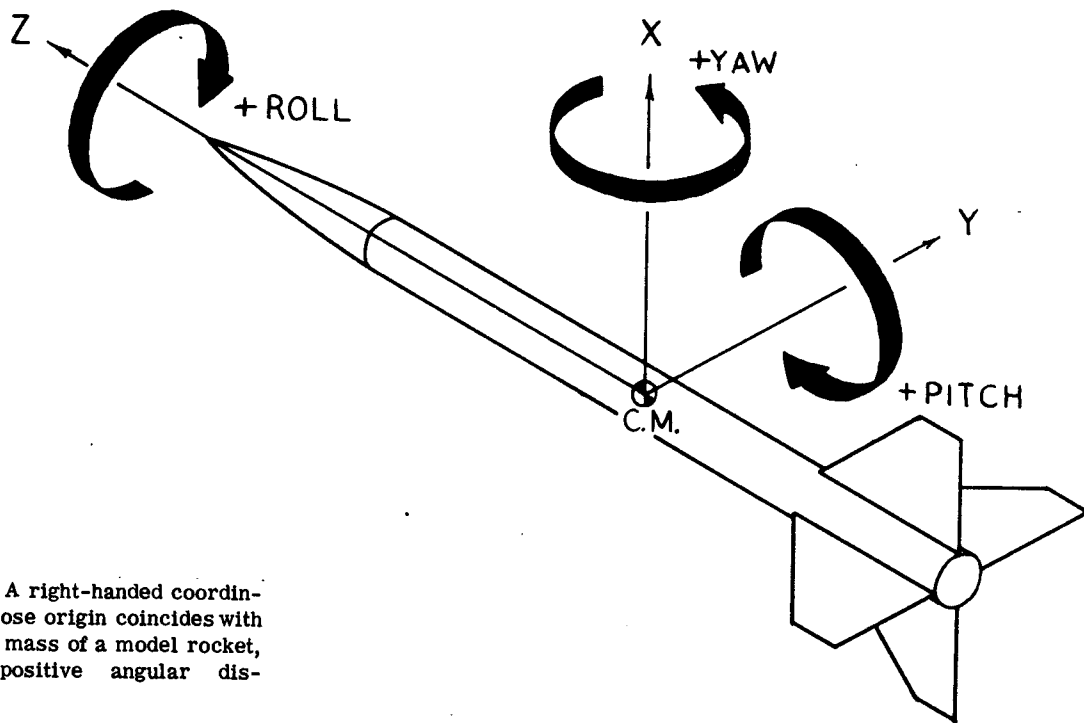

FIGURE 1. A right-handed coordinate system whose origin coincides with the center of mass of a model rocket, illustrating positive angular displacements.

Model rocketry has long been well acquainted with the analysis of static stability. For over ten years the widely-used silhouette technique for approximating the center of pressure of a streamlined body has permitted the modeler to design rockets whose static stability margin is adequate for normal flying, and with the advent of the Barrowman method the static stability margin of any given model has become determinable to a high order of accuracy.

The static stability margin, however, while necessary to any prediction regarding stability, is insufficient to in-

sure acceptable behavior under all the conditions a model rocket may encounter during flight. Disturbances of certain types may cause even a statically-stable rocket to undergo motions deleterious, or even catastrophic, to the intended flight plan. The behavior of a model rocket in this respect is governed by the rigid-body dynamics of streamlined projectiles subjected to aerodynamic forces.

Our hobby received its first exposure to dynamic stability analysis through a lecture delivered by Luther W. Gurkin of the National Aeronautics and Space Administration to rocketeers

attending the sixth National Association of Rocketry Annual Meet at NASA Wallops Station in August of 1964. Little was done, however, to apply the results of the Gurkin report directly to the design of model rockets and the topic lay dormant for several years. This writer took up the problem early in 1968 and by March of that year had progressed far enough to deliver a talk on the subject to the Massachusetts Institute of Technology Model Rocketry Convention.

In the following series of articles we shall present, in three parts, the results of a complete analysis of the

dynamic behavior of streamlined projectiles possessing at least trigonal mass symmetry about their longitudinal axes. For the benefit of those who are mathematically inclined, the analysis has been based on a linearization of the aerodynamic moments for small perturbations, a technique which makes possible the closed-form solution of the mathematical relationships governing this kind of behavior. Euler's dynamical equations, as they are called, are differential equations requiring the techniques of calculus for their solution.

In this first of three articles we describe the dynamic behavior of model rockets which are not spinning about their longitudinal axes. The second article will repeat the presentation for models having a finite spin rate; the third will present experimental methods and empirical techniques which have been found useful in determining the characteristics of model rockets which govern dynamic behavior. We shall conclude the series with the formulation of a design philosophy permitting the practical application of our results to the design of a typical rocket.

PART I

PROBLEMS IN ZERO ROLL RATE The Dynamic Parameters

Consider a model rocket placed with respect to a coordinate system as shown in Figure 1. This particular set of axes is termed a right-handed set and its convention for the signs of rotations has been indicated. Let us assume that a constant yawing moment M_x is applied to such a rocket, which has been suspended by its center of mass in a vacuum. We find, in such a case, that the rocket yaws with an angular velocity $\dot{\alpha}_x$ that increases linearly with time according to the relation

$$\dot{\alpha}_x = \frac{M_x}{I_L} t$$

where t denotes time in seconds and the constant I_L is called the longitudinal moment of inertia of the rocket. In one consistent set of units the yaw rate $\dot{\alpha}_x$ might be given in radians/second (one radian is $1/360$ of 360 degrees, or about 57.3 degrees). This means that, if M_x is given in dyne-centimeters, the proper units for I_L are dyne-cm-sec², or the equivalent form of gram-cm². Provided that the rocket has the rotational symmetry required for our analysis (which most model rockets do), we will find that the angular acceleration of the rocket in pitch is governed by

FIGURE 2. A typical example of the variation of damping moment with yaw rate.

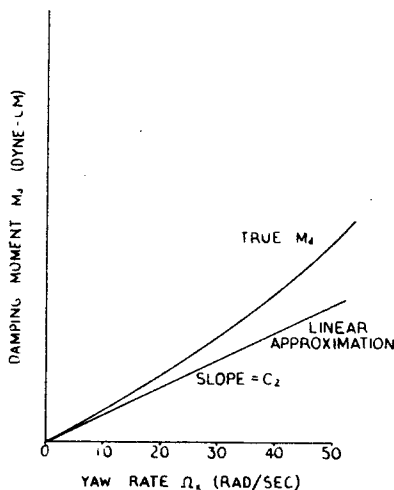
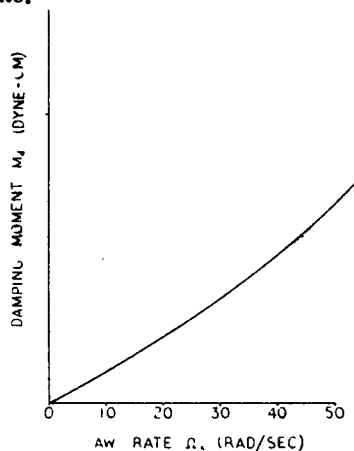

FIGURE 3. Linearization about zero of the damping moment curve.

$$\dot{\alpha}_x = \frac{M_x}{I_L} t$$

If the rocket is spun up in roll, however, the equation $\dot{\alpha}_z = \frac{M_z}{I_R} t$ will describe its angular velocity, where I_R is not generally equal to I_L . I_R is termed the radial moment of inertia; in any reasonable rocket it will be much smaller than I_L .

Let us now suspend our rocket in a still atmosphere and again apply a constant yawing moment. This time we will find that the yaw rate does not continue to increase without bound as time goes on, but instead eventually reaches a terminal value and thereafter remains constant. Since there is no longer any angular acceleration after this happens, we conclude that the applied moment has been balanced by an equal and opposite damping moment due to the drag of the air on the rotating rocket. A typical example of the variation of damping moment with yaw

FIGURE 4. A typical example of the variation of corrective moment with yaw angle.

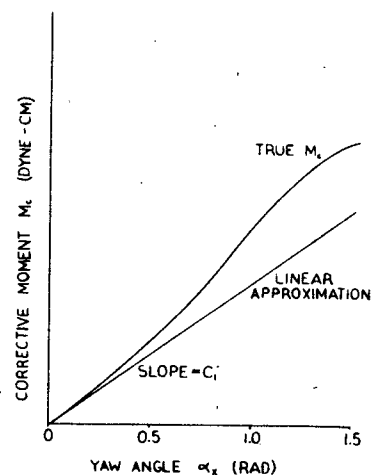
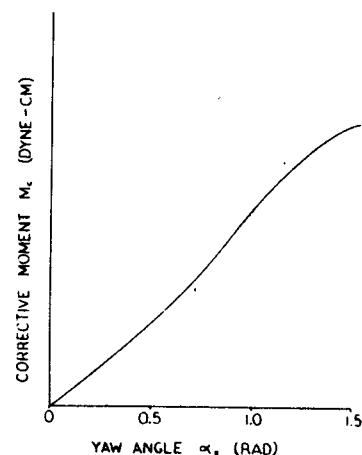

FIGURE 5. Linearization about zero of the corrective moment curve.

rate is shown in Figure 2. If a straight line is drawn through the origin of the graph illustrated in Figure 2 such that the slope of this line is equal to the slope of the damping moment curve at the origin an approximation to the true curve will be generated whose accuracy is acceptable for small enough values of yaw rate. This construction has been carried out in Figure 3. We define the slope of the linear approximation as C_2 , the damping moment coefficient; in the system of units we have been using we would express it in dyne-cm-sec.

Finally, we shall take our hypothetical rocket and suspend it by its center of mass in a moving airstream. Upon applying a constant yawing moment we now find that, after a time, the model comes to rest at a yaw angle α_x which is a function of the speed of the airstream and the static stability margin of the rocket (we are

assuming for the present that it is statically stable). Since no angular acceleration occurs after the rocket has come to rest at this angle we again conclude that the applied yawing moment is being balanced by an equal and opposite moment, this time a corrective moment due to the velocity of the airstream. A graph of corrective moment versus yaw angle at a given value of airspeed is presented for one possible rocket design in Figure 4. The linear approximation to this curve may be constructed in the same way as in the case of the damping moment curve; such a "linearization about zero" is shown in Figure 5. We define the slope of the straight line in this instance as C_1 , the corrective moment coefficient, to be given in dyne-cm*. We see that this linearization is a good approximation to the true corrective moment curve for sufficiently small yaw angles.

The damping and corrective moment coefficients for pitching motion will be identical to those for yawing motion in cruciform rockets only, strictly speaking, but experience and observation indicate that the error incurred in assuming that the same equality holds in the case of triform rockets is, for the purposes of the hobbyist, negligible. The limitation of the linearized theory as a whole to relatively small values of angular displacement and angular velocity is also acceptable, for the following reasons: First, the vast majority of dynamic responses will fall within the limits of acceptable accuracy. Secondly, should we encounter a solution predicting continued large and violent displacements we will not be interested in the precise description of the motion. We will have obtained all the information we need from the linearized theory: that the rocket in question ought to be redesigned. Within the linearized theory a knowledge of the dynamic parameters I_L , C_1 , and C_2 enables us to determine the nature of the dynamic response of any given rocket to a given disturbance, provided that the rocket in question is not spinning about its longitudinal axis. In the case of rockets which are spinning, the value of I_R and of the roll rate must also be known.

Problem 1. Homogeneous Response to General Initial Conditions

*Radians, being physically dimensionless, do not appear in the units of either or is thus given in dyne-cm rather than dyne-cm/rad, in dyne-cm-sec rather than dyne-cm-sec/rad.

The homogeneous response, also called the characteristic motion, describes the behavior of a model rocket subsequent to its encountering a disturbance in flight which imparts to it some initial angular displacement and some initial angular velocity. In this and all subsequent discussions in this article we shall be presenting solutions to disturbances in yaw alone with the understanding that pitching behavior is analogous.

Over a range of values of I_L , C_1 , and C_2 such that $\frac{C_1^2}{4I_L^2} < \frac{C_2}{I_L}$ the variation of yaw angle with time (hereafter referred to as the solution, or response) is given by

$$(1) \quad \alpha_x = A e^{-\delta t} \sin(\omega t + \varphi)$$

where e is the base of the Napierian, or natural system of logarithms and is numerically equal to roughly 2.718. Values of e raised to any power, as it appears in equation 1, may be found in tables of exponential functions, which

are arranged in much the same way as trigonometric tables. t denotes time (considered to be zero at the conclusion of the transient disturbance) and A , D , and φ are constants. A is called the initial amplitude, $(1/D)$ is defined as the time constant, ω (not literally an angular velocity of the rocket) is the angular frequency, and φ is the phase angle, or simply "phase." ω and D are determined by the dynamic parameters as follows:

$$(2) \quad \omega = \sqrt{\frac{C_1}{I_L} - \frac{C_2}{4I_L^2}}$$

$$(3) \quad D = \frac{C_1}{2I_L}$$

A and φ are determined by ω , D , and the initial values of the yaw angle and yaw rate. Let α_{x0} be the value of the yaw angle and $\dot{\alpha}_{x0}$ the value of the yaw rate at $t = 0$; then

$$(4) \quad A = \sqrt{\alpha_{x0}^2 + \left(\frac{\dot{\alpha}_{x0} + \Omega \alpha_{x0}}{\omega}\right)^2}$$

FIGURE 6. Simple harmonic motion: undamped characteristic response for general initial conditions. The time to reach the first zero, the period of the oscillation, and the relation of the initial conditions to the properties of the response are illustrated.

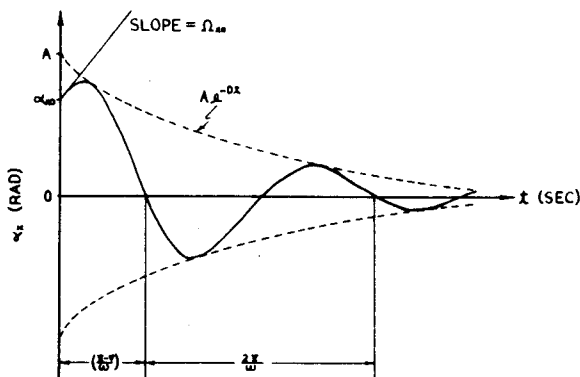
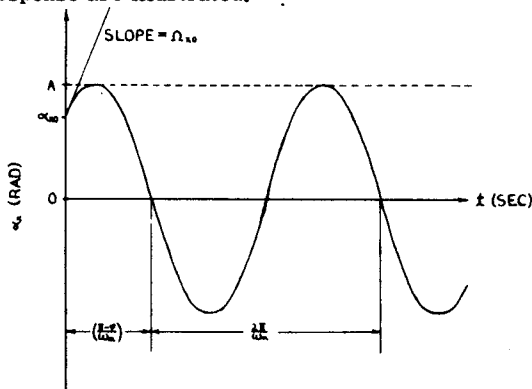

FIGURE 7. Underdamped characteristic response for general initial conditions. The time to reach the first zero, the period of the oscillation, the exponential decay of amplitude and the relation of the initial conditions to the properties of the response are illustrated.

$$(5) \quad \varphi = \text{ARCTAN} \left(\frac{\alpha_{no} \omega}{D\alpha_{no} + \Omega_{no}} \right)$$

where the notation "arctan" has the interpretation, "that angle whose tangent is . . .". Motion of this kind is called an exponentially damped sinusoid and its nature is determined by the relative values of the dynamic parameters.

For $C_2 = 0$, the case of zero damping, the expression for yaw becomes

$$(6) \quad \alpha_x = A \sin(\omega_n t + \varphi)$$

where $\omega_n = \sqrt{\frac{C_1}{I_L}}$ ω_n is known as the natural frequency of the rocket at the given airspeed*. The response is simple harmonic motion: sinusoidal oscillations of angular frequency ω_n at constant amplitude A , as shown in Figure 6. This kind of motion never literally occurs, as there always exists some aerodynamic damping; it is a so-called limiting case, meaning that it is closely approximated for very small values of $C_2/2I_L$. Such vanishingly small damping is undesirable, for it means that the oscillations will persist for many cycles without dying away. Under such conditions the rocket will present a greater average frontal area to the airstream; consequently the drag will be increased. Since there is a side force on the yawed rocket, some altitude will also be lost due to the resulting "ripple" in the flight path as the rocket, considered as a point-mass, moves from side to side. For zero damping true alignment would never be restored.

For values of the dynamic parameters such that $0 < \frac{C_2}{4I_L} < \frac{C_1}{I_L}$ have the case of underdamped motion. The oscillations have the appearance of a sine curve confined within a "decaying exponential" curve, as shown in Figure 7. The angular frequency is smaller than the natural frequency and the amplitude of the oscillations decreases toward zero with time. The characteristics of almost all model rockets are such that the homogeneous response will be of this nature at most airspeeds. This is a desirable type of behavior, for it is in this range of values of $C_2/2I_L$ that the most rapid restoration of true align-

*The quantities presented in this treatment bear the following relation to those of the Gurkin report:

Present Treatment

Gurkin Report

$$\omega_n = \sqrt{\frac{C_1}{I_L}}$$

$$\omega_n = \sqrt{\frac{M_1}{I}}$$

$$D = \frac{C_2}{2I_L}$$

$$d = \frac{M_2}{2I}$$

FIGURE 8. Critically-damped characteristic response for general initial conditions. The relation of the initial conditions to the properties of the response are shown.

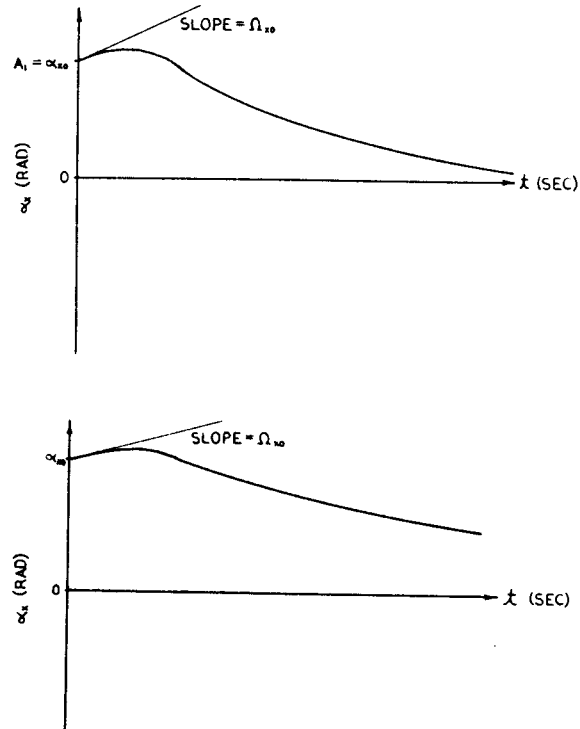

FIGURE 9. Overdamped characteristic response for general initial conditions, showing the relation of the initial conditions to the properties of the response.

ment occurs. If we define a damping ratio ζ by

$$(7) \quad \zeta = \frac{C_2}{2\sqrt{C_1 I_L}}$$

and agree to consider straight flight to have been restored when the magnitude of the yaw angle drops below and never again exceeds 5% of A , we find that the most rapid return to straight flight occurs when ζ reaches $\sqrt{2}/2$, or about

.7071. Damping ratios greater than this value result in a slower restoration because the decrease in the angular frequency becomes more important than the decrease in the number of cycles required. We can express ω in terms of the damping ratio as

$$\omega = \omega_n \sqrt{1 - \zeta^2}$$

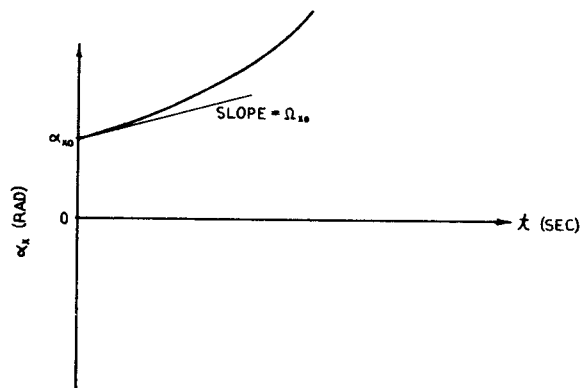

FIGURE 10. Characteristic response of a statically-unstable rocket to general initial conditions. The yaw angle grows, rather than decays, with time.

For optimum damping at any airspeed ω is just $.7071\omega$. As ζ approaches 1.0 ω approaches zero and when a unity damping ratio is reached, the case of critical damping, the motion ceases to be oscillatory. The form of solution given in equation 1 is no longer valid.

For the case $\zeta = 1$, corresponding to $\frac{C_2^2}{4I_L^2} = \frac{C_1}{I_L}$, the response is given by

$$(8) \quad \alpha_x = (A_1 + A_2 t) e^{-\omega t}$$

where $D = \frac{C_1}{2I_L}$ as before, while

$$(9a) \quad A_1 = \alpha_{x0} \quad \text{and}$$

$$(9b) \quad A_2 = \Omega_{x0} + D\alpha_{x0}$$

The motion for this case is illustrated in Figure 8. Note that α_x never crosses to the opposite side of the t axis from that on which it originates, and is thus said to exhibit "no overshoot." Critically damped motion is less desirable than underdamped motion; the time to restore alignment is longer and the rocket will be shifted to one side by the action of the side force in one direction only. The flight path will also take a noticeable "set," acquiring an inclination away from the vertical due to the resulting lateral velocity component.

For cases in which $\frac{C_2^2}{4I_L^2} > \frac{C_1}{I_L}$ corresponding to $\zeta > 1$, the motion obeys the relation

$$(10) \quad \alpha_x = A_1 e^{-\frac{t}{\tau_1}} + A_2 e^{-\frac{t}{\tau_2}}$$

where τ_1 and τ_2 are called the time constants of the response and are given by

$$(11a) \quad \tau_1 = \frac{1}{\frac{C_2}{2I_L} - \sqrt{\frac{C_2^2}{4I_L^2} - \frac{C_1}{I_L}}}$$

$$(11b) \quad \tau_2 = \frac{1}{\frac{C_2}{2I_L} + \sqrt{\frac{C_2^2}{4I_L^2} - \frac{C_1}{I_L}}}$$

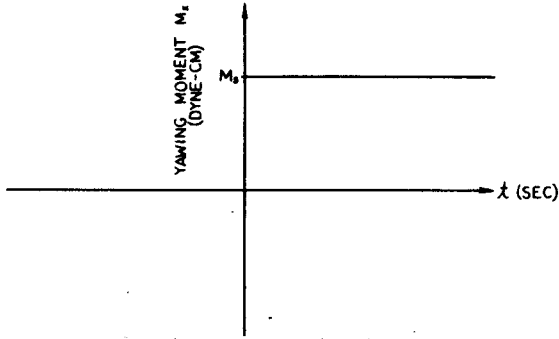

FIGURE 11. A step disturbance of value M_x . The yawing moment is zero before the origin, M_x after it.

FIGURE 12. Undamped step-response, showing the coordinates of the first peak. The rocket oscillates indefinitely about the value M_x / C_1 .

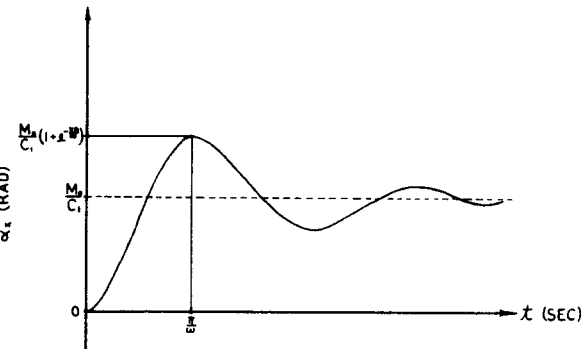
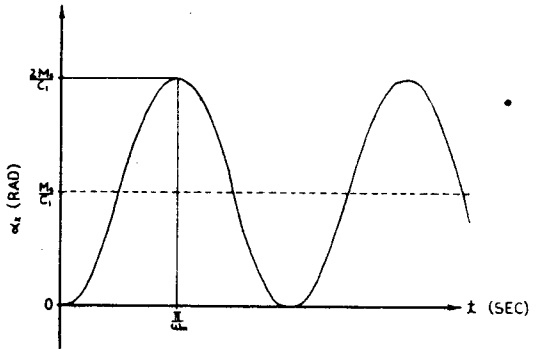

FIGURE 13. Underdamped step-response, illustrating the coordinates of the first peak. A yaw angle of M_x / C_1 is approached as time increases.

The constants A_1 and A_2 are determined by the initial yaw angle and yaw rate as follows:

$$(12a) \quad A_1 = \frac{\tau_1 \alpha_{x0} + \tau_1 \tau_2 \Omega_{x0}}{\tau_1 - \tau_2}$$

$$(12b) \quad A_2 = \frac{\tau_2 \alpha_{x0} + \tau_1 \tau_2 \Omega_{x0}}{\tau_2 - \tau_1}$$

A response of this kind is called overdamped; its behavior is shown in Figure 9. Overdamped motion de-

cays more slowly than critically-damped motion and, like the critically-damped response, has no overshoot. Overdamping is a highly undesirable condition and may produce catastrophic behavior, for large changes in the flight path almost as severe as those resulting from neutral static stability can be produced. In fact, neutral and negative static stability ($C_1 \leq 0$) are both special cases of the motion described by equation 10. The dynamic yaw-response of a statically-unstable rocket is illustrated in Figure 10.

Problem 2. Step-Response for Zero Initial Conditions

One type of disturbance a model rocket may encounter during flight is the so-called step input, a disturbing moment that suddenly arises as a result of such occurrences as minor structural failure, deflection of control surfaces, exhaust deflection or the entry of the rocket into a wind shear, and thereafter remains constant. The form of a yaw disturbance of this type is shown in Figure 11, in which we have

FIGURE 14. Critically-damped step-response. The yaw angle M_g/C_1 is now approached monotonically.

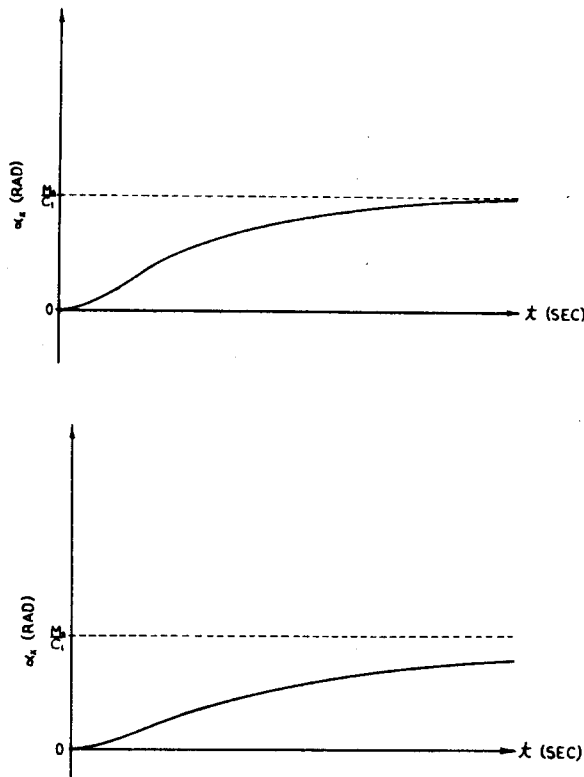

FIGURE 15. Overdamped step-response. Note the increased sluggishness of the behavior.

set the zero of our time scale to the point in time at which the step occurs. We shall present the effect of such a "forcing function" on a rocket which has, for all time prior to the application of the step, been flying "straight and true," with all angular displacements and velocities equal to zero.

Let the value of the step input be denoted by M_g . The step-response for underdamped rockets is then given by

$$(13) \alpha_x = A e^{-Dx} \sin(\omega x + \varphi) + \frac{M_g}{C_1}$$

where ω and D are computed according to equations 2 and 3, respectively. The phase angle is given by

$$(14) \varphi = \text{ARCTAN} \left(\frac{\omega}{D} \right)$$

and the initial amplitude by

$$(15) A = -\frac{M_g}{C_1 \sin \varphi}$$

Since the response is oscillatory in nature it will exhibit a series of peaks. In the undamped case there is no decrease in the magnitude of these peaks with time, but for underdamped motion the first peak is the largest; it represents the maximum yaw angle produced by the step and is therefore of special interest. The first peak occurs at a

time

$$(16) t_{MAX} = \frac{\pi}{\omega}$$

after the application of the step, and at this time the yaw angle is given by

$$(17) \alpha_{XMAX} = \frac{M_g}{C_1} (1 + e^{-W})$$

Step-responses for zero damping and a representative underdamped case are illustrated in Figures 12 and 13, respectively.

A critically-damped step-response is governed by the equation

$$(18) \alpha_x = (A_1 + A_2 t) e^{-Dx} + \frac{M_g}{C_1}$$

where, again, D is given by equation 3. The initial amplitudes A_1 and A_2 are determined by the equations

$$(19a) A_1 = -\frac{M_g}{C_1} \quad \text{and}$$

$$(19b) A_2 = -D \frac{M_g}{C_1}$$

Figure 14 illustrates this behavior, in which the peaking characteristic has disappeared and the time taken to approach the terminal value of M_g/C_1 is greatly increased. This also means an increase in the time required to return to a yaw angle of zero should the disturbance disappear, however, so the critically-damped state remains undesirable.

The overdamped response to a step input is described by the relation

$$(20) \alpha_x = A_1 e^{-\frac{x}{T_1}} + A_2 e^{-\frac{x}{T_2}} + \frac{M_g}{C_1}$$

where T_1 and T_2 are given by equations 11 and the initial amplitudes by

$$(21a) A_1 = -\frac{M_g T_1}{C_1(T_1 - T_2)}$$

$$(21b) A_2 = \frac{M_g T_2}{C_1(T_1 - T_2)}$$

As we see in Figure 15, the step-response of an overdamped rocket is so sluggish that the rocket in question would never regain anything like true alignment in time to avert a dangerously large shift in the flight path if the disturbance should subside.

One characteristic shared by all forms of statically-stable step-response is that a final yaw angle of M_g/C_1 radians is always approached. The reciprocal dependence on the corrective moment coefficient means that large values of C_1 will minimize the

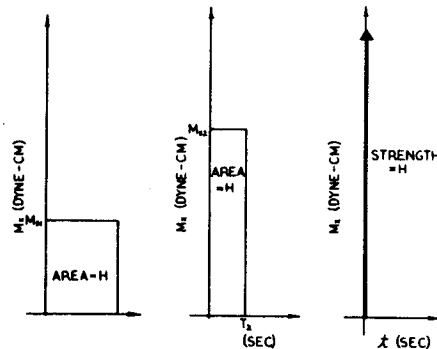

FIGURE 16. Development of the concept of an impulse from a configuration of steps. The development proceeds from left to right.

severity of the response. C_1 , in turn, may be increased by adopting a greater static stability margin in conjunction with a sufficiently high airspeed throughout all phases of flight.

Problem 3. Impulse-Response for Zero Initial Conditions

Another form of disturbance that can dynamically affect the flight of a model rocket is a short, sharp "kick" such as the moments which may occur due to launcher contact during firing and those due to staging transients, wind gusts, or the expulsion of solid residue at an angle from the rocket nozzle. Such forcing functions are approximated for the purposes of analysis by impulses, which may be constructed from step functions by the following "limiting argument": Consider a step form of disturbance which rises to a value of M_s , persists for a time T , and then "steps down" to zero again. Define the

FIGURE 17. Underdamped impulse-response, showing the initial angular velocity and the coordinates of the maximum yaw angle.

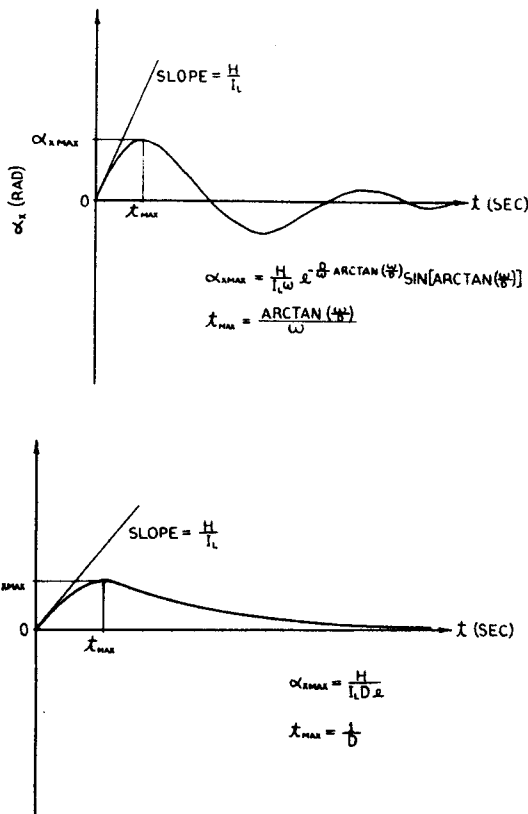

FIGURE 18. Critically-damped impulse-response, showing the initial angular velocity and the coordinates of the maximum yaw angle.

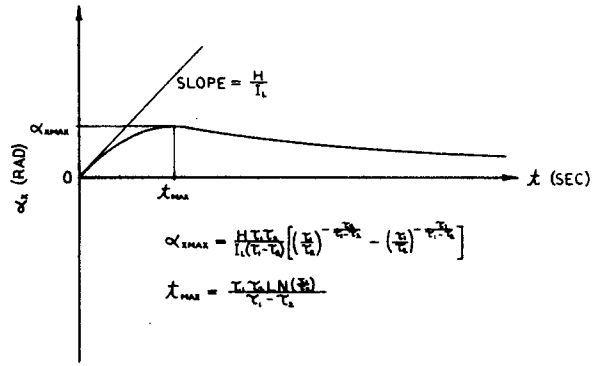

FIGURE 19. Overdamped impulse-response, showing the initial angular velocity and the coordinates of the maximum yaw angle. The notation "LN" refers to the natural logarithm of the quantity in parentheses, a function which is available in tables in much the same manner as trigonometric functions.

area of the rectangle formed by this function and the time axis as H , which will be equal to $M_s T$. Now consider what would happen if M_s became larger and T became smaller in such a way

that the product of the two remained constant, namely H . If we carry this process to the point where T approaches zero, we will no longer be able to represent M_s on paper, for it will become infinite - but always in such a way that the product $M_s T$ equals H . In this case we represent the area function by a heavy vertical line capped by an arrow and call it an impulse of strength H . The development of the impulse from the step configuration is illustrated in Figure 16.

In this section we present the response of a model rocket to an impulse in yaw, under the assumption that both yaw angle and yaw rate are zero before the application of the impulse. The point in time at which the impulse occurs is taken to be the zero of the time scale.

Actually, the impulse-response is just a special case of characteristic response for which the initial yaw angle and yaw rate are, respectively,

(22a) $\alpha_{x0} = 0$
 (22b) $\Omega_{x0} = \frac{H}{I_1}$

Underdamped impulse-responses are described by equations 1 through 3, with the undamped case given by equation 6. The initial amplitude and phase angle are

(23) $A = \frac{H}{I_1 \omega}$ and

(24) $\varphi = 0$

The maximum yaw angle reached in response to the impulsive disturbance is

$\alpha_{xMAX} = \frac{H}{I_1 \omega} e^{-\delta \cdot \text{ARCTAN}(\frac{\omega}{\delta})} \text{SIN}[\text{ARCTAN}(\frac{\omega}{\delta})]$

and it occurs at a time

$$(26) \quad t_{MAX} = \frac{\text{ARCTAN}(\frac{H}{C_1})}{\omega}$$

after the application of the impulse. An underdamped impulse-response is shown in Figure 17; the special case of zero damping is not illustrated, as it should by now be easy to visualize.

The critically-damped impulse-response is described by equation 8, in which

$$(27a) \quad A_1 = 0 \quad \text{and}$$

$$(27b) \quad A_2 = \frac{H}{L}$$

The maximum yaw angle reached in this case is given by

$$(28) \quad \alpha_{XMAX} = \frac{H}{L \cdot 0.2}$$

and it occurs at a time

$$(29) \quad t_{MAX} = \frac{1}{\omega}$$

after the impulse occurs. Figure 18 illustrates the behavior of a critically-damped impulse-response.

In the case of an overdamped rocket the impulse-response behavior is governed by equations 10 and 11, with

$$(30a) \quad A_1 = \frac{H \tau_1 \tau_2}{L(\tau_1 - \tau_2)}$$

$$(30b) \quad A_2 = -\frac{H \tau_1 \tau_2}{L(\tau_1 - \tau_2)}$$

The maximum yaw angle is here given by

$$(31) \quad \alpha_{XMAX} = \frac{H \tau_1 \tau_2}{L(\tau_1 - \tau_2)} \left[\left(\frac{\tau_1}{\tau_2} \right)^{-\frac{\tau_1}{\tau_2 - \tau_1}} - \left(\frac{\tau_2}{\tau_1} \right)^{-\frac{\tau_2}{\tau_1 - \tau_2}} \right]$$

and its time of occurrence by

$$(32) \quad t_{MAX} = \frac{\tau_1 \tau_2 \ln(\frac{\tau_1}{\tau_2})}{\tau_1 - \tau_2}$$

An overdamped impulse-response is shown in Figure 19.

Upon working a number of examples

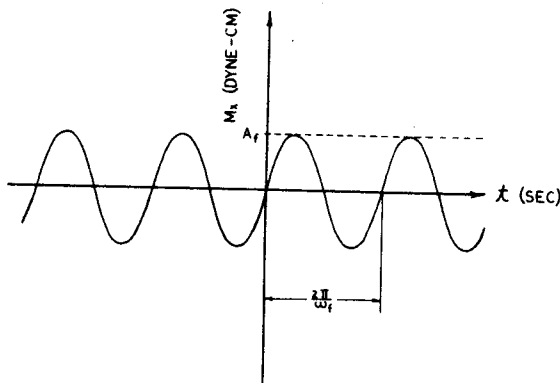

FIGURE 20. Steady-state sinusoidal forcing, showing the constant amplitude and the period of the oscillatory disturbance. Note that the disturbing moment is, for the purposes of analysis, considered to have been going on for all time.

FIGURE 21. The variation of amplitude ratio with frequency ratio for rockets having various damping ratios, showing the resonant behavior of those whose damping ratios are less than 2/2. For damping ratios greater than this value no resonance occurs.

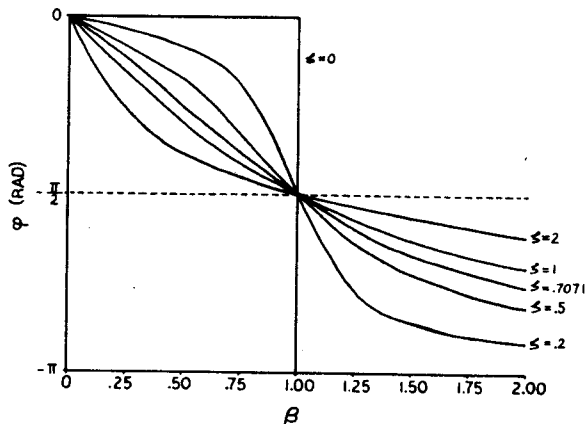
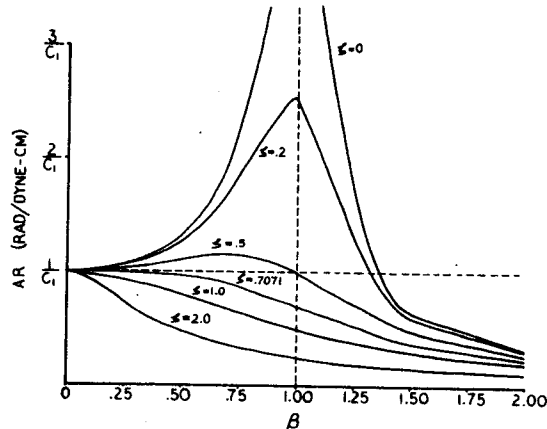

FIGURE 22. The variation of phase angle with frequency ratio for rockets having various damping ratios.

we would find that, all else being equal, an increase in damping decreases the maximum yaw angle. We already know, however, that the nonoscillatory nature

and slow restoration characteristic of critically-damped and overdamped motion makes this an undesirable method of decreasing a rocket's sensitivity to impulsive forcing. A more immediately obvious possibility lies in the reciprocal dependence of the maximum yaw angle on the longitudinal moment of inertia, and indeed the best way of minimizing the severity of the impulse-response is to increase the value of I . Adequate values of C and I , besides improving step-response and impulse-response behavior, are seen by equation 7 to lessen the danger of overdamping.

Problem 4. Steady-State Response to Sinusoidal Forcing

A third class of disturbances capable of affecting model rocket flight characteristics includes oscillatory mo-

ments arising from such causes as the "flutter" of fins or control surfaces and periodic angular fluctuations in the rocket exhaust due to certain types of combustion or nozzle-flow instability. Such disturbances are handled analytically by solving the steady-state response to sinusoidal forcing, meaning the motion that occurs in response to the oscillatory disturbance after sufficient time has passed since the initiation of the disturbance for transient phenomena to have died away. In this treatment the disturbance is considered to be a sinusoidal function of angular frequency ω_f and amplitude A_f . Assuming forcing in yaw alone, this means

$$M_x = A_f \sin \omega_f t$$

Figure 20 shows such a forcing function. The subject of this final discussion in the first section of our presentation is the motion produced by disturbances of this type.

No matter what the damping ratio, the steady-state response to sinusoidal forcing in yaw will be given by

$$(33) \quad \alpha_x = A_r \sin(\omega_f t + \varphi)$$

The angular frequency is identical to that of the forcing function, but the amplitude of the response is generally different from that of the disturbance and there is a difference in phase between the two. The response amplitude is governed by the equation

$$(34) \quad A_r = \frac{A_f}{\sqrt{(I_1 \omega_f^2 - C_1)^2 + C_2^2 \omega_f^2}}$$

and the phase difference by

$$(35) \quad \varphi = \text{ARCTAN} \left[\frac{C_2 \omega_f}{I_1 \omega_f^2 - C_1} \right]$$

If we define a frequency ratio β by

$$(36) \quad \beta = \frac{\omega_f}{\omega_n}$$

and an amplitude ratio AR by

$$(37) \quad AR = \frac{A_r}{A_f}$$

we can, with the aid of the damping ratio formulation given in equation 7, obtain the forms

$$(38) \quad AR = \frac{1}{C_1 \sqrt{(\beta^2 - 1)^2 + (2\zeta\beta)^2}}$$

$$(39) \quad \varphi = \text{ARCTAN} \left[\frac{2\zeta\beta}{\beta^2 - 1} \right]$$

which are commonly used in this type of analysis. Sinusoidal steady-state analysis considers the amplitude ratio and phase angle as functions of frequency ratio, with C_1 and ζ as parameters. Plots of AR and φ versus β for a number of values of ζ are given in Figures 21 and 22.

We can see for ζ less than $\sqrt{2}/2$ there exists a region of the frequency domain in which the value of AR is greater than $1/C_1$, exhibiting a peak at a frequency ratio somewhat less than 1. This phenomenon is referred to as resonance and the frequency at which the resonance peak occurs is defined as the resonant frequency, given by

$$(40) \quad \omega_{RES} = \omega_n \sqrt{1 - 2\zeta^2}$$

The value of AR at this frequency is of special interest, since it is associated with the maximum amplitude of the response. It is given by the equation

$$(41) \quad AR_{RES} = \frac{1}{2C_1 \zeta \sqrt{1 - \zeta^2}}$$

For small values of damping the value of AR can be dangerously high. A tiny

oscillatory disturbance can produce such severe oscillations in response that the flight of the rocket may be seriously disrupted - or even catastrophically terminated by a major structural failure. For $\zeta = 0$ the resonant amplitude ratio is predicted to be infinite. As the damping increases AR_{RES} decreases toward $1/C_1$ and ω_{RES} decreases toward zero, which values are reached when $\zeta = \sqrt{2}/2$. Beyond this value of the damping ratio the resonant behavior disappears and equations 40 and 41 are no longer applicable.

For all values of the phase angle is seen to decrease from zero toward $-\pi$ radians as β increases from zero toward infinity, passing through $-\pi/2$ at

1. The "sharpness" of the transition increases as the damping decreases, becoming a step at damping decreases, becoming a step at $\zeta = 0$. Because ζ is always negative for non-zero values of frequency the response is said to "lag" the disturbance.

A consideration of steady-state sinusoidal response emphasizes the necessity of having an adequate amount of damping present to keep the resonant amplitude within acceptable limits - without, however, resorting to overdamping. It will generally be necessary to accept the possibility of some degree of resonant behavior, since ζ cannot be kept between .7071 and 1.0 during the fastest part of the flight (near burnout) without being greater than 1.0 during the slowest part (launch). For any given value the severity of the resonance can be decreased by increasing the value of C_1 ; a procedure which, it will be recalled, also decreases the response to step disturbances.

q & a

Between the metal launch rod and the metal blast deflector on my launcher, my ignition clips get shorted out quite often. How can I prevent the shorting?

M. C.
Baton Rouge, La.

I have found that plastic tape over the micro-clips does not restrict opening the jaws. In an emergency masking tape will also work quite well. The type of clips with plastic covering over the body also make good ignition clips. They are sold as jumper clips in most radio-electronic stores.

Myself and a couple friends launch together all the time. We would like to become members of the National Association of Rocketry and form an official club. Would you please give us the address of the National Association of Rocketry and how to join.

D. M.
Springfield, Mass.

You can write to the NAR at 1239 Vermont Ave. N.W., Washington, D.C.

20005. Ask for membership forms and a section application. Rocketeers can become junior, leader, or senior members, depending on age. To become a section, a rocket club must have at least 10 NAR members, including 2 senior members or a senior and a leader member. You must have your club constitution accepted by the NAR before your section can be chartered. There are many advantages to becoming an NAR member. The NAR provides insurance which is invaluable in getting launching sites. Sanctioned local, regional, and national competition in model rocket events is held throughout the country. News from other sections and the use of the NAR Technical Services for help in model rocketry activities are also very useful.

EGGLOFTER II

One of the strangest events in any model rocket meet is the eggloft. For those who have never participated in this contest, the idea is to loft a raw egg as high as possible, and recover it without cracking the shell. (See the NAR eggloft rules in box).

For this event you're practically forced to design your own rocket. The commercially produced ones have a maximum payload inner diameter of 1.6 inches. This is just a little bit too small to accommodate a large, Grade A, hen's egg. You could of course use a smaller egg and a commercial rocket, but if you're going to launch an egg you might as well go all the way. Egglofter II is designed around an Estes PST-65R plastic payload tube which has a 1.75 inch inner diameter.

Egglofter II can be assembled in either of two engine configurations. It can be powered by a single engine, in which case only the B4-2 (B.8-2 in the old classification) can be used. No more than 100 ft altitude is possible with the single engine vehicle. With a three engine cluster powering the Egglofter II, however, altitudes in excess of 1000 feet are possible. For the cluster, three C6-7's, B6-6's, or A8-5's can be used.

Since all of the parts for Egglofter II are commercially available (see parts list) assembly is quite easy. The nose cone should be lightly sanded and painted. The adapter cone should be glued securely to the payload section, or it may fall off at parachute deployment and allow the egg to drop to the ground. If the fit is too loose, wrap a layer of tape around the mating surface of the nose cone. This should improve the fit.

Egglofter II should be flown with 2 parachutes. One 18" chute should be attached directly to a screw eye in the base of the adapter cone. A second 18" chute should be attached by about 8" of shock cord to a point about 2 inches from the top of the BT-60 body tube. The body tube and the payload compartment should not be connected during recovery.

NAR EGGLOFTER RULES

26.1 This competition comprises a single event open to entries weighing no more than 500 grams (1.1 pounds), powered by an engine or engines whose total impulse does not exceed 80.00 Newton-seconds in any combination, and carrying as a totally enclosed payload a single, fresh, Grade A hen's egg.

26.2 The purpose of this competition is to carry an exceedingly fragile payload to as high an altitude as possible and to recover the fragile payload without damage. The fresh egg payload is intended to simulate in miniature form an astronaut who must be properly cushioned and restrained to withstand the forces of acceleration and the shock of re-entry, recovery and landing.

26.3 The judges will provide a fresh egg to each contestant as a payload upon the contestant presenting his entry for pre-launch safety checkout. Each egg will be numbered. The contestant will insert the egg into his entry in the presence of the judges.

26.4 The entry will be tracked to obtain a maximum altitude figure. The entry achieving the highest altitude and recovery without breaking the egg will be declared the winner.

6.5 Following the flight, the contestant shall present his entry as recovered and in the presence of the judges remove the egg. The judges will determine the extent of damage to the egg.

26.6 If the shell of the egg is broken or cracked, the entry will be disqualified.

26.7 The weighting factor for the Egg Lofting Competition is 3.

To prepare for flight put a 1" layer of cotton (packed down tight) in the payload section. Insert the egg, and fill the payload section with cotton. Check that the nose cone fits tightly. It is important that cotton be packed firmly around the egg. If the egg can move easily, it will very likely break. Egglofter II may require additional nose weight if it is flown without a payload.

One word of warning. Don't fly Egglofter II with the B14 series of engines unless you like scrambled eggs!

Egglofter II Parts List

- 1 BNC-65L Nose Cone
- 1 Pst-65R Plastic Tube
- 1 TA-6065 Adapter
- 1 BT-60D Body Tube
- 1 EH-2060 Engine Mount (for single engine version)
- 3 BT-20J and 3 EB-20A (for three engine cluster)
- 1/8" thick x 3" wide balsa for fins
- 2 18" parachutes

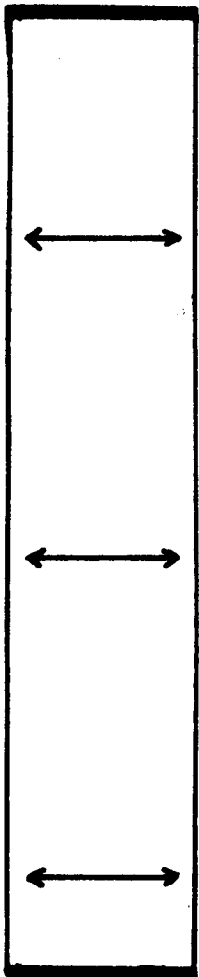
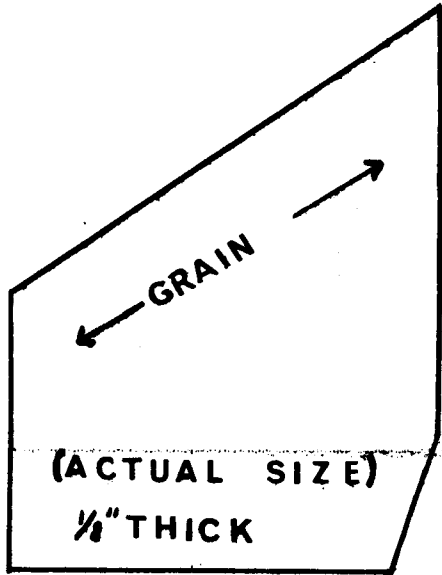

Fin guide: Trace and wrap around rocket body. Arrows indicate fin placement.

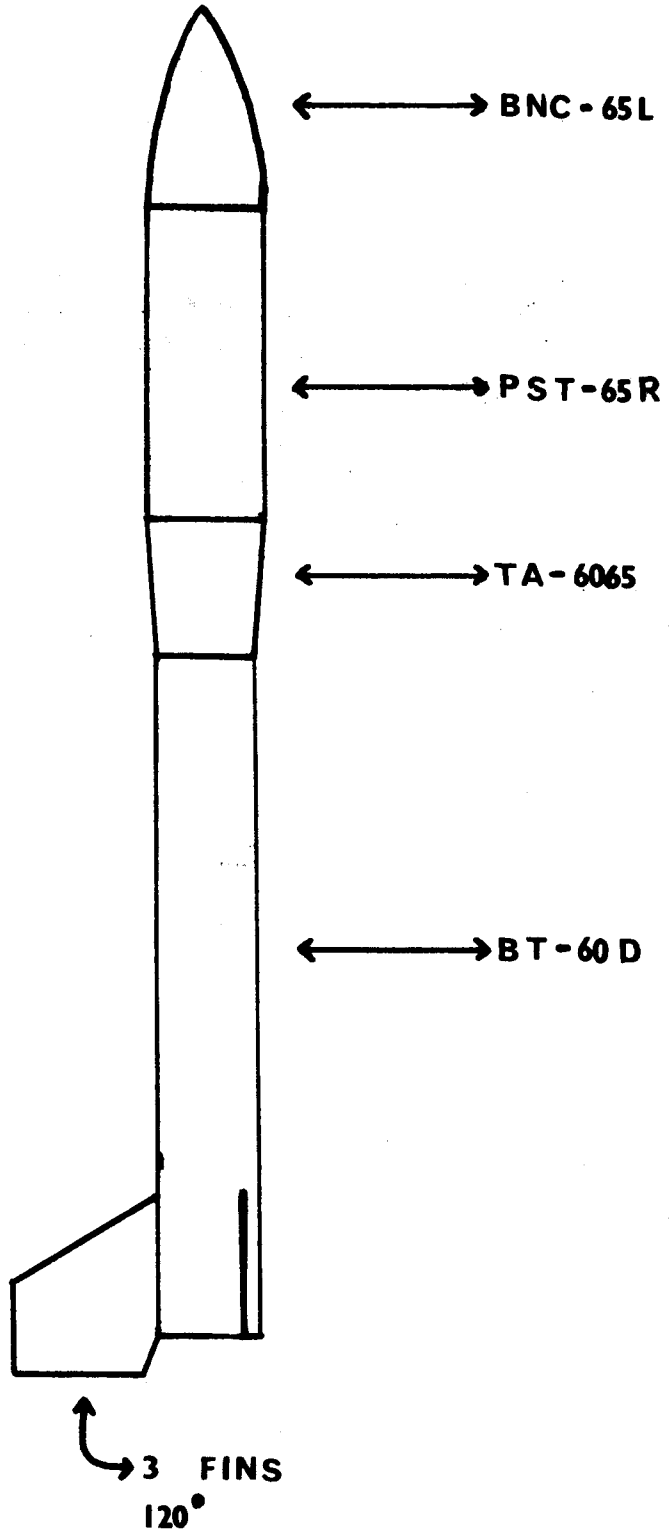

TECHNICAL

NOTES

GEORGE CAPORASO

Since its inception, model rocketry has relied ever increasingly on science and technology for its innovations and developments, until today where the value of model rocketry as an educational tool and as an object of legitimate scientific research is well established.

This column will present an overview of all the important technical features and developments in model rocketry as they have happened, as they are happening now and as they will happen.

We will provide accurate and up to date technical reports dealing with static stability, new altitude calcula-

tion methods, the very large area of dynamic stability and oscillations, transmitters, instrumentation, boost glider reports, drag and wind tunnel analysis, and more.

Old and new material will be presented on a simple and also on a very advanced level.

I will also editorialize on what I think model rocketry needs working on, and on where it should concentrate its scientific and engineering efforts.

Occasionally I will stick my neck out and espouse a particular controversial viewpoint in order to generate and crystallize what I hope will be a healthy criticism and scientific dialogue di-

rected at clearing up the matter in question. Oh boy, have I got a load of unsolved questions to be answered.

Each month I may spend some time on posing an unsolved problem and discussing some of the written in answers to previous questions.

I will start with one this month. It concerns the matter of pressure drag on fins. Is it negligible? Is it on the same order as nose cone pressure drag? You know if you compare the cross-section area of the body tube to the fins on most rockets you'll find that they are on the same order. And if the pressure drag is appreciable, what is the optimum subsonic shape? A tapered front or leading edge is the shape for minimum drag for supersonic flight. Is it just as good for subsonic speeds?

Here's another one for you. Just how much, if at all, does the engine exhaust reduce the drag coefficient during burning? What effect does the smoke charge have on the base drag?

Please send your opinions to:

George Caporaso
c/o Model Rocketry
Box 214

Boston, Mass. 02123

Next month we will present a technical discussion of altitude calculations.

Hobby Shops

Your local hobby shops can supply balsa wood, decals, tools, paint, magazines, and many other model rocket supplies.

Mention Model Rocketry to your local hobby dealer.

MODEL ROCKET SUPPLIES
TOTOWA HOBBY SHOP
Harold M. Zafeman
279-0106 388 Union Ave.
Paterson 2, N. J.

We Sell Estes Rocket Kits
and Supplies
Mail Orders Filled
PAVONE'S SHOE HOSPITAL
20 Margret Street
Platsburg, New York, 12901

MODELS - MODEL SUPPLIES -
ACCESSORIES - AIRPLANES -
ROCKETS - ROCKET SUPPLIES
Fred's Variety
184 Success Ave. Phone
Bridgeport, Conn. 334-5347

Western New York Headquarters for Rockets and Supplies is
GRELL'S FAMILY HOBBY SHOP
5225 Main St.
Williamsville, New York
Open 7 days a week Phone 632-3165

Centuri - Estes - MRI
Send Self-addressed stamped envelope for free listing of all the latest in hobby kits at special prices.
Bristol Hobby Center
43 Middle St.
Bristol, Conn., 06010

TUCSON, ARIZONA....
"in Tucson" it's
DON'S HOBBY
for model Rocketry
2954 N. Tucson Blvd. 327-0565

Support your local
HOBBY SHOP



For Outstanding Achievement in Your Rocketry Activities

Depend on
ESTES INDUSTRIES
MODEL ROCKETRY
KITS & SUPPLIES

Join the thousands of rocketeers who follow Estes' lead to more exciting rocketry

A complete program of model rocketry for the beginner of more experienced modeler



ESTES
Estes technical research helps you to build better flying models

FLIGHTS UP TO 2500 FT.



HERE'S WHERE ROCKET ACTION BEGINS

Huge fact-filled illustrated color catalog . . . 25c

As the pioneer in the space-age hobby, we have made it our business to keep customers informed of the latest developments in rocketry, and to provide an unbeatable selection of kits to build and fly.

Our catalog is filled with helpful building, finishing and flying information . . . Estes research has developed many technical reports, available to rocketeers. And Model Rocket News goes to customers to keep them abreast.

Over 35 kits to build and fly; including the largest selection of flying true scale models anywhere, such as the big 37" Saturn 1-B (left); great beginners kits, like the Alpha (center); the Camroc, the world's only aerial rocket camera.



BE ON THE ESTES TEAM OF ROCKETEERS. FILL OUT AND SEND US THE COUPON BELOW

Estes Industries, Dept. 31, Penrose, Colo. 81240
COUNT ME ON YOUR TEAM

- I am already an Estes customer. Keep information coming.
- Please send your catalog (25c enclosed) so I can become an Estes rocketeer and keep pace in model rocketry.

Name

Address

City

State Zip